



Southwire™

HAND TOOLS

CATALOG



**BUILT FOR DURABILITY.
BUILT FOR RELIABILITY.
BUILT FOR WORK.™**

SOUTHWIRE.COM

OUR STORY

For over 60 years, Southwire has provided high quality electrical wire and cable to the commercial and industrial construction industries. Now, the name you trust provides durable, cutting-edge professional grade tools, designed with safety and productivity in mind. Look to Southwire for solutions to all your electrical needs, from electrician's hand tools, meters, contractor equipment, temporary power, and extension cords.

Southwire, The Company

Southwire Company, LLC is North America's leading manufacturer of wire and cable used in the distribution and transmission of electricity. Throughout its history, our company has sought to help provide power through our products, our service and by helping empower our customers, employees, and communities. With more than 6,800 people at customer service centers, manufacturing facilities and sales offices throughout North America, we are dedicated to developing the highest-quality products and legendary service.

Southwire, The People

With more than 6,800 people at customer service centers, manufacturing facilities and sales offices throughout North America, we are dedicated to developing the highest-quality products and legendary service.

The Drive For Excellence

Driving for excellence starts with being responsive to our customers and the markets we serve. By creating business units, Southwire Company enables each to foster an entrepreneurial spirit, innovative solutions, and responsiveness required in today's business. At the same time each division can leverage the resources and rich history of Southwire Company as a whole.

The Products

To be successful requires products that give you solutions no matter what stage of the project cycle you are in. Our product teams and dedicated resources work together to listen to and work with our customers, creating solutions that deliver unparalleled value through product innovation, safety and efficiency.

The Service

Service is more than a word or a phone number; it's a tangible support system that assists you through the entire project cycle. Starting with our own knowledgeable customer service team, to our National Field Sales team, and our District Merchandising Specialists. In the office or in the field, we're there to lend a hand, just when you need it most. Feel free to reach us at 1-855-SWT00LS (855-798-6657).



TABLE OF CONTENTS

HAND TOOLS

- Pliers.....7
- Wounded Warrior Project®
Limited Edition Products.....14
- Stripping & Cutting16
- Cutters18
- Knives23
- Drivers24
- Hex Keys34
- Levels35
- Bags.....36
- Accessories39
- Kits.....41

VOICE • DATA • VIDEO

- Cutters44
- Cutting & Stripping46
- Prep Tool49
- Punch Down Tools50
- Crimping Tools.....51

FISHING & BENDING

- SIMpull™ Fishtapes.....59
- Stainless Steel Fishtapes62
- Steel Fishtapes63
- Fishtape Leader64
- Fish Sticks64
- Conduit Hand Benders65
- Cable Hand Benders66

TEST & MEASUREMENT

- Multimeters70
- Clamp Meters80
- Voltage Testers.....86
- NCVs89
- Testers.....93
- IR Thermometers97
- Test Kits.....99



THE Southwire ADVANTAGE



12%
EASIER CUTS*

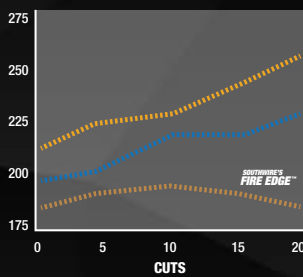

● SOUTHWIRE
● COMPETITOR 1 ● COMPETITOR 2

*Based on 3rd Party Force vs Cut Load Cell Testing using Southwire Side Cutting Pliers vs leading national brands.



2X
MORE HANDLE STABILITY*

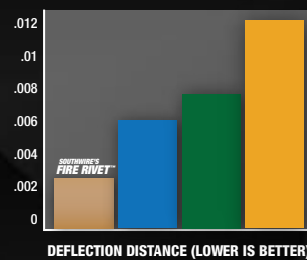

● SOUTHWIRE ● COMPETITOR 1
● COMPETITOR 2 ● COMPETITOR 3

*Based on 3rd Party Joint Integrity Testing measuring handle deflection using Southwire Diagonal Cutting pliers vs leading national brands



2X
EASIER TO OPEN JAWS*

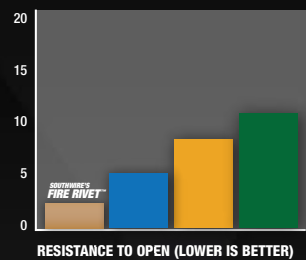

● SOUTHWIRE ● COMPETITOR 1
● COMPETITOR 2 ● COMPETITOR 3

*Based on 3rd Party Jaw Opening Testing measuring average force to open plier jaws using Southwire Terminal Crimping Pliers vs leading national brands.

THE Southwire ADVANTAGE



SCP9TPCB



REAMING HEAD

12AWG SOL WIRE STRIPPER

FIRE EDGE™ BLADES

FIRE RIVET™ TECHNOLOGY

6-32 & 8-32 BOLT SHEARS

CRIMPER & FISHTAPE PULLER

GUARANTEED FOR LIFE



COMPETITOR 1

HAND TOOLS

Your hands are your most important tools, the ones you need for every job. Equip them with high-quality, durable hand tools from Southwire. With a strong yet comfortable design and no-hassle lifetime warranty, you can rely on these tools to make your life easier and last through years of hard work.



HAND TOOLS

HIGH LEVERAGE SIDE CUTTING PLIERS

SCP9TPCB



SCP9TPC



SCP9C



SCP9



SCP9D



SCP9CD



Our high leverage side cutting pliers offer a streamlined design with sure-gripping, cross-hatched knurled jaws.

- Induction-hardened cutting blades ensure efficient and lasting cutting surfaces for hard and soft wire
- Drop forged CRV steel for durability
- File teeth on jaws help remove burrs in conduit
- Curved ergonomic handle for comfortable use

SPECIFICATIONS

COMFORT GRIP

| MODEL # | STOCK # | DESCRIPTION | | |
|----------|----------|---|-------|----------|
| SCP9TPC | 58993140 | High Leverage Side Cutting Pliers w/ Fish Tape Puller & Crimper | | |
| SCP9C | 58993040 | High Leverage Side Cutting Pliers w/ Crimper | | |
| SCP9 | 58992940 | High Leverage Side Cutting Pliers | | |
| SCP9TPCB | 65028940 | High Leverage Side Cutting Combo Pliers | | |
| | HEIGHT | WIDTH | DEPTH | WEIGHT |
| SCP9TPC | 9.5" | 2.5" | 0.88" | 1.19 lbs |
| SCP9C | 9.5" | 2.5" | 0.88" | 1.19 lbs |
| SCP9 | 9.5" | 2.5" | 0.88" | 1.19 lbs |
| SCP9TPCB | 9.00" | 2.5" | 0.79" | 1.16 lbs |

DIPPED GRIP

| MODEL # | STOCK # | DESCRIPTION | | |
|---------|----------|---|-------|----------|
| SCP9D | 58289840 | High Leverage Diagonal Cutting Pliers w/ Dipped Handle | | |
| SCP9CD | 58749140 | High Leverage Diagonal Cutting Pliers w/ Crimper Dipped Handles | | |
| | HEIGHT | WIDTH | DEPTH | WEIGHT |
| SCP9D | 9.5" | 2.13" | 0.75" | 1.19 lbs |
| SCP9CD | 9.5" | 2.13" | 0.75" | 1.19 lbs |



HAND TOOLS | PLIERS

HAND TOOLS

LONG NOSE PLIERS

LNP8SD



Southwire long nose pliers provide a better grip without sacrificing tool strength or durability.

- Knurled jaws for sure-gripping
- Drop forged CRV steel for durability
- High leverage, hot rivet design for smooth action and no handle wobble
- Long nose design for forming and looping wire and handling small parts
- Precision induction-hardened cutting knives for long-lasting cutting edge

LNP7D



SPECIFICATIONS

DIPPED GRIP

| MODEL # | STOCK # | DESCRIPTION | | |
|---------|----------|---|-------|----------|
| LNP8SD | 58289740 | 8" Hvy. Dty. Long Nose Pliers Side Cutting Stripper Dipped Handle | | |
| LNP7D | 58749040 | 7" Long Nose Pliers w/ Side Cut Dipped Handle | | |
| | HEIGHT | WIDTH | DEPTH | WEIGHT |
| LNP8SD | 8.38" | 2.13" | 0.63" | 0.64 lbs |
| LNP7D | 7.38" | 2.13" | 0.63" | 0.38 lbs |

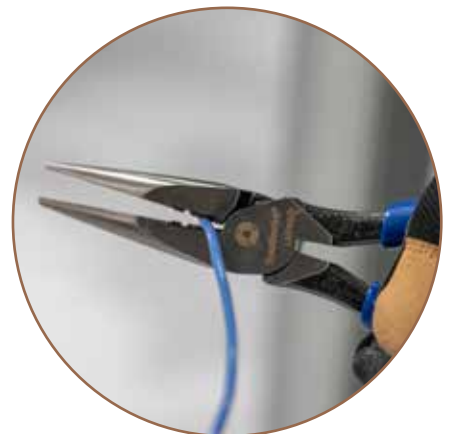
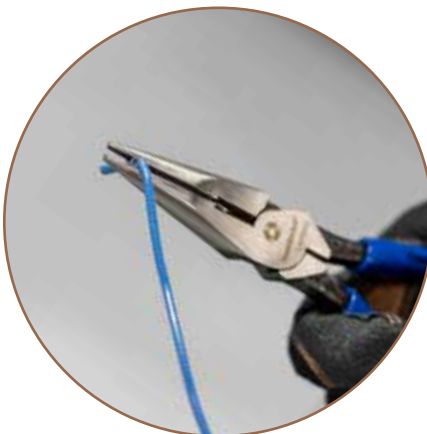

HAND TOOLS

HIGH LEVERAGE DIAGONAL CUTTING PLIERS

DCP8



DCPA8



The high leverage design of these diagonal cutting pliers provides greater cutting power while the hot riveted joint ensures smooth action with no handle wobble.

- Drop forged CRV steel for durability
- Induction hardened cutting blades ensure efficient and lasting cutting surfaces
- High leverage design provides maximum cutting power
- Hot riveted pivot joint provides smooth action and no wobble
- Effectively cuts most hardened wire, ACSR, bolts, screws, and nails



*DCPA8 and DCPA8D

DCP8D



DCPA8D



DCP6D



SPECIFICATIONS

COMFORT GRIP

| MODEL # | STOCK # | DESCRIPTION | | |
|---------|----------|---|-------|----------|
| DCP8 | 58993340 | 8" High Leverage Diagonal Cutting Pliers | | |
| DCPA8 | 58993240 | 8" High Leverage Diagonal Cutting Pliers w/ Angled Head | | |
| | HEIGHT | WIDTH | DEPTH | WEIGHT |
| DCP8 | 8.25" | 2.25" | 0.75" | 0.73 lbs |
| DCPA8 | 8.25" | 2.25" | 0.75" | 0.73 lbs |

DIPPED GRIP

| MODEL # | STOCK # | DESCRIPTION | | |
|---------|----------|---|-------|----------|
| DCP8D | 58289440 | 8" High Leverage Diagonal Cutting Pliers w/ Dipped Handle | | |
| DCPA8D | 58289540 | 8" High Leverage Diagonal Cutting Pliers w/ Angled Head and Dipped Handle | | |
| DCP6D | 58739940 | 6" High Leverage Diagonal Cutting Pliers Dip Handle | | |
| | HEIGHT | WIDTH | DEPTH | WEIGHT |
| DCP8D | 8" | 2" | 0.63" | 0.61 lbs |
| DCPA8D | 8" | 2" | 0.63" | 0.61 lbs |
| DCP6D | 6" | 2" | 0.63" | 0.40 lbs |

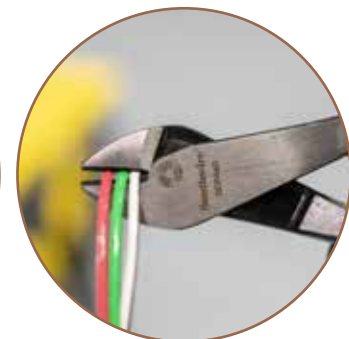

HAND TOOLS | PLIERS

HAND TOOLS

CABLE CUTTERS

CCP9



CCP9DE



CCPR400



CCP350



CCPR400S



CCP750



CCPR1K



CCP6D



The hook jaws grab and hold cable while the shear cutting action allows for clean cuts.

- Heat treated, precision ground blades ensure clean cuts
- Comfortable cushion grips reduce hand fatigue
- Forged steel with black-oxide finish for long life
- High leverage pivot joint ensures smooth action and no handle wobble

SPECIFICATIONS

COMFORT GRIP

| MODEL # | STOCK # | DESCRIPTION | | |
|----------|----------|--|-------|----------|
| CCP9 | 58993540 | 9" High Leverage Cable Cutter | | |
| CCP350 | 59158540 | 350 MCM 16" Cable Cutter | | |
| CCP750 | 58738240 | 750 MCM 31" Fiberglass Handle Cable Cutter | | |
| CCPR400 | 58277740 | 750 MCM Ratcheting Cable Cutter | | |
| CCPR400S | 59556240 | 600 MCM Ratcheting Cable Cutter | | |
| CCPR1K | 58738340 | 1K MCM Ratcheting with Telescoping Handles | | |
| | HEIGHT | WIDTH | DEPTH | WEIGHT |
| CCP9 | 9.38" | 2.13" | 0.63" | 0.94 lbs |
| CCP350 | 18.90" | 4.53" | 1.18" | 2.55 lbs |
| CCP750 | 31" | 5.32" | 1.23" | 5.50 lbs |
| CCPR400 | 13.78" | 6.81" | 1.57" | 0.51 lbs |
| CCPR400S | 9.25" | 5.71" | 1.57" | 1.54 lbs |
| CCPR1K | 16.20" | 7.10" | 2.70" | 7.33 lbs |

DIPPED GRIP

| MODEL # | STOCK # | DESCRIPTION | | |
|---------|----------|---|-------|----------|
| CCP9DE | 64323040 | 9" High-Leverage Cable Cutters w/ Ergonomic Dipped Handle | | |
| CCP6D | 58748940 | 6 1/2" Cable Cutting Shears w/ Dipped Handle | | |
| | HEIGHT | WIDTH | DEPTH | WEIGHT |
| CCP9DE | 9.25" | 1.8" | 0.62" | 1 lbs |
| CCP6D | 6.75" | 2" | 0.75" | 0.51 lbs |



TERMINAL CRIMPING | CUTTING PLIERS

TCC9

TCC9D



These high leverage crimping pliers have two die positions that permit the tool to crimp insulated and non-insulated terminals and ferrules.

- Tapered nose for working in confined spaces
- Crimps 10-22 AWG solderless terminals and connectors
- Specially hardened wire cutter in nose
- Curved handle and ergonomic molded grip for comfortable use
- Crimps insulated and non-insulated terminals and connectors

SPECIFICATIONS

| MODEL # | STOCK # | DESCRIPTION | | |
|---------|----------|--|-------|----------|
| TCC9 | 58993640 | Terminal Crimper Cutter w/ Comfort Grip Handle | | |
| TCC9D | 58289940 | Terminal Crimper Cutter w/ Dipped Handle | | |
| | HEIGHT | WIDTH | DEPTH | WEIGHT |
| TCC9D | 9.75" | 2.38" | 0.63" | 0.79 lbs |
| TCC9 | 9.38" | 1.88" | 0.75" | 0.86 lbs |



HAND TOOLS

MULTI-TOOL PLIERS

S7N1HD



S816SOLHD



SNM1214HD



S5N1



Versatile spring action pliers that perform multiple functions.

- Grip, strip, crimp, ream, shear, and cut
- Narrow knurled jaw allows access to tight spaces
- Cuts small gauge copper wire and communication cables
- Crimps common size wire ferrules
- Reams and smooths thin-wall conduit ends
- Easily strips 10-14 AWG solid wire
- Durable forged construction for lasting performance
- Comfortable grips minimize hand wear and fatigue
- Strips:
 - S7N1HD: 10-14 AWG Solid, 12-16 Stranded
 - S816SOLHD: 8-16 AWG Solid, 10-18 Stranded
 - SNM1214HD: 12/2 and 14/2 Romex

SPECIFICATIONS

| MODEL # | STOCK # | DESCRIPTION | | |
|-----------|----------|--|-------|----------|
| S7N1HD | 65028440 | 7-in-1 Long Nose Multi-Tool Plier | | |
| S5N1 | 58993940 | 5-in-1 Multi-Tool Plier | | |
| S816SOLHD | 65028140 | Forged Wire Stripper 8-16 AWG Solid 10-18 AWG Stranded | | |
| SNM1214HD | 65028240 | Forged Romex Stripper 12-14 AWG Solid w/ Ergo Grip | | |
| | HEIGHT | WIDTH | DEPTH | WEIGHT |
| S7N1HD | 10.24" | 3.54" | 0.98" | 0.79 lbs |
| S5N1 | 10.10" | 3.54" | 0.70" | 0.65 lbs |
| S816SOLHD | 10.24" | 3.54" | 0.98" | 0.71 lbs |
| SNM1214HD | 10.04" | 3.54" | 0.79" | 0.74 lbs |



MULTI-PURPOSE SIDE CUTTING PLIER

MPSCP



Multi-purpose side cutting plier cuts ACSR, screws, nails, and most hardened wire.

- Drop forged construction for durability
- High-leverage pivot joint for easier cuts
- Strips 8-14 AWG solid and 10-16 stranded
- 6-32 and 8-32 screw shearing

SPECIFICATIONS

| MODEL # | STOCK # | DESCRIPTION | | |
|---------|----------|----------------------------------|--------|---------|
| MPSCP | 59724440 | Multi-Purpose Side Cutting Plier | | |
| HEIGHT | WIDTH | DEPTH | WEIGHT | |
| MPSCP | 11.38" | 3.75" | 1.50" | 0.6 lbs |



HAND TOOLS

MADE IN USA PLIERS - WOUNDED WARRIOR PROJECT®

SCP9TPCD-WW



DCPA8D-WW



CCP9D-WW



TCC9D-WW



Made from American forged steel, these tools are built to withstand jobsite wear and tear. Assembled with hot rivet technology, these pliers are designed to be the livelihood of every professional. Proudly supporting Wounded Warrior Project®.

- Hot riveted pivot joint for smooth action
- Induction hardened
- Hand sharpened blades
- Drop forged USA steel for durability

SPECIFICATIONS

| MODEL # | STOCK # | DESCRIPTION |
|-------------|----------|--|
| SCP9TPCD-WW | 67038040 | Made in USA 9" High-Leverage Side Cutting Pliers w/ Fish Tape Puller, Crimper, & Dipped Grip Handles |
| DCPA8D-WW | 67038340 | Made in USA 8" Angled Head High-Leverage Diagonal Cutting Pliers w/ Dipped Handles |
| CCP9D-WW | 67038940 | Made in USA 9" High-Leverage Cable Cutters w/ Dipped Grip Handles |
| TCC9D-WW | 67038640 | Made in USA 9" Terminal Crimper/Cutter w/ Dipped Grip Handles |

| | HEIGHT | WIDTH | DEPTH | WEIGHT |
|-------------|--------|-------|--------|----------|
| SCP9TPCD-WW | 11.75" | 3.88" | 11.75" | 1.1 lbs |
| DCPA8D-WW | 10.13" | 3.88" | 10.13" | 0.6 lbs |
| CCP9D-WW | 11.75" | 3.88" | 11.75" | 1.05 lbs |
| TCC9D-WW | 11.75" | 3.88" | 11.75" | 0.9 lbs |



 **WE'VE GOT IT
MADE IN AMERICA™**

WOUNDED WARRIOR PROJECT®
LIMITED EDITION PRODUCTS

HAND TOOLS

HAND TOOLS

MADE IN USA WIRE STRIPPERS - WOUNDED WARRIOR PROJECT®

S1018SOL-WW

S1020SOL-WW

Made from durable, heat-treated steel, the Made in USA wire strippers & cutters are equipped to handle day-to-day jobsite demands. Proudly supporting the Wounded Warrior Project®.



- Double-dipped grip for comfortable fit
- Serrated nose holds cable for easy twisting and pulling
- Spring-loaded for self-opening action

SPECIFICATIONS

| MODEL # | STOCK # | DESCRIPTION | | |
|--------------|----------|---|-------|----------|
| S1018SOL-WW | 67039540 | 10-18 AWG Solid Wire Stripper Ergo Handles | | |
| S1020SOL-WW | 67039240 | 10-20 AWG Solid Wire Stripper Compact Handles | | |
| SNM1214HH-WW | 67039840 | Romex® Brand BOXJaw™ Wire Stripper | | |
| | HEIGHT | WIDTH | DEPTH | WEIGHT |
| S1018SOL-WW | 8.5" | 4" | 0.5" | 0.37 lbs |
| S1020SOL-WW | 8.5" | 4" | 0.5" | 0.32 lbs |
| SNM1214HH-WW | 9.75" | 4" | 1.5" | 0.4 lbs |

SNM1214HH-WW



 **WE'VE GOT IT
MADE IN AMERICA™**

HAND TOOLS | **WOUNDED WARRIOR PROJECT®**
LIMITED EDITION PRODUCTS

HAND TOOLS

WIRE STRIPPERS & CUTTERS

S1018SOL



Made of stainless steel, these wire strippers have precision ground stripping holes and are fitted with comfortable double-dipped plastic grips.

- Stainless steel construction is durable and rust-proof
- Serrated nose grasps the cable for easy twisting and pulling
- Double-dipped grip provides comfortable feel
- Spring loaded for self-opening action
- Specially designed cutting blades provide fast and clean wire stripping and cutting

S612STR



S1018STR



S1626STR



SPECIFICATIONS

| MODEL # | STOCK # | DESCRIPTION | | |
|----------|----------|---|-------|----------|
| S1018SOL | 58278040 | Wire Stripper Cutter 10-18SOL;12-20 Stranded Ergonomic Handle | | |
| S1018STR | 58278140 | Compact Stripper Cutter 10-18 AWG Solid | | |
| S612STR | 58277940 | Wire Stripper Cutter 6-12 AWG Stranded Ergonomic Handle | | |
| S1626STR | 58278240 | Compact Stripper Cutter 16-26 AWG Stranded | | |
| | HEIGHT | WIDTH | DEPTH | WEIGHT |
| S1018SOL | 7.63" | 2.38" | 0.69" | 0.33 lbs |
| S1018STR | 6.25" | 2.5" | 0.69" | 0.29 lbs |
| S612STR | 7.38" | 2.5" | 0.63" | 0.33 lbs |
| S1626STR | 6.25" | 2" | 0.69" | 0.28 lbs |



HAND TOOLS

WIRE STRIPPERS & CUTTERS

SNM1012



SNM1214



Made of stainless steel, these wire strippers have precision ground stripping holes and are fitted with comfortable double-dipped plastic grips.

- Stainless steel* construction is durable and rust-proof
- Serrated nose grasps the cable for easy twisting and pulling
- Specially designed cutting blades provide fast and clean wire stripping and cutting
- Double-dipped grip provides comfortable fit
- Spring loaded for self-opening action (on models SNM1012, SNM1214)

MP61



MPLN



SVN



SPECIFICATIONS

| MODEL # | STOCK # | DESCRIPTION |
|---------|----------|---|
| SNM1012 | 58278440 | NM Cable Stripper Cutter 10-12 AWG Ergonomic Handle |
| SNM1214 | 58278540 | NM Cable Stripper Cutter 12-14 AWG Ergonomic Handle |
| MP61 | 58278940 | 6-in-1 Multipurpose Stripper |
| MPLN | 58278840 | Long Nose Multipurpose Tool |
| SVN | 58278740 | Wire Stripper V-Notch |

| | HEIGHT | WIDTH | DEPTH | WEIGHT |
|---------|--------|-------|-------|----------|
| SNM1012 | 8.13" | 2.19" | 0.69" | 0.36 lbs |
| SNM1214 | 7.88" | 2.19" | 0.69" | 0.36 lbs |
| MP61 | 9" | 2.38" | 0.69" | 0.43 lbs |
| MPLN | 8.5" | 2.38" | 0.75" | 0.36 lbs |
| SVN | 5.25" | 2.31" | 0.44" | 0.14 lbs |

*Excludes SVN

HAND TOOLS

ELECTRICIAN'S SCISSORS

ES001



Unlike regular scissors or shears, the serrated blades keep wire from slipping out of the jaws, so that cutting through hardware cloth, cable, wire netting, and other difficult-to-cut materials becomes an easy task.

- Durable nickel-plated steel for resistance from rust and corrosion
- Strips 19 AWG & 23 AWG
- Scraper and file on outside of both blades

SPECIFICATIONS

| MODEL # | STOCK # | DESCRIPTION | | |
|---------|----------|------------------------|--------|----------|
| ES001 | 58283540 | Electrician's Scissors | | |
| HEIGHT | WIDTH | DEPTH | WEIGHT | |
| ES001 | 5.38" | 2.19" | 0.38" | 0.19 lbs |

PLASTIC PIPE CUTTER

PLACUT



Our plastic pipe and tube cutter has non-slip grips and a strong stainless steel blade that makes cutting plastic tubing easy.

- Easily performs flush cuts on rigid plastic tubing
- Durable design for rugged use
- Locking latch allows easy one-handed operation
- Cuts up to 3/4" PVC and 1-5/8" flexible tubing

SPECIFICATIONS

| MODEL # | STOCK # | DESCRIPTION | | |
|---------|----------|---------------------|--------|----------|
| PLACUT | 58282140 | Plastic Pipe Cutter | | |
| HEIGHT | WIDTH | DEPTH | WEIGHT | |
| PLACUT | 8.75" | 1.83" | 1.17" | 0.35 lbs |

HAND TOOLS

ROTO-SPLIT® CUTTERS - WOUNDED WARRIOR PROJECT®



RS-101A-WW

 WE'VE GOT IT
MADE IN AMERICA™

The RS-101-WW will become your everyday cutter for MC Cable. It features a thumb screw to clamp and release the cable. It is simple, straight forward, and easy to use. You'll never do another MC Cable job without it. Proudly made in the USA.

- Cuts and strips any armored cable from AWG 14-2 to 10-4 as well as AC, MC & HCF cables
- After initial setting only a half turn of the thumb screw is needed to clamp or release the cable
- Make cuts quickly and easily in tight quarters
- Durable die cast epoxy-enameled body

SPECIFICATIONS

| MODEL # | STOCK # | DESCRIPTION | WEIGHT | MIN OPENING | MAX OPENING | FLEX (TRADE SIZE) | AWG SOL OR MC RANGE |
|-------------|----------|--|--------|-------------|-------------|-------------------|---------------------|
| MCCUT-WW | 66979340 | BX MC Rotary Cutter w/Lever | | | | | |
| RS-101A-WW | 66978140 | RS-101A-WW Super Roto-Split® Cutter | | | | | |
| RS-101AC-WW | 66978440 | RS-101AC-WW Automatic Roto-Split® Cutter | | | | | |
| MCCUT-WW | 1.2 lbs | 0.375" | 0.75" | 3/8" | 14/2 to 8/4 | | |
| RS-101A-WW | 1.2 lbs | 0.375" | 0.75" | 3/8" | 14/2 to 8/4 | | |
| RS-101AC-WW | 1.2 lbs | 0.375" | 0.75" | 3/8" | 14/2 to 8/4 | | |

ROTO-FLEX® CUTTERS - WOUNDED WARRIOR PROJECT®



RF-170-WW

 WE'VE GOT IT
MADE IN AMERICA™

Easily handles all common MC, BX, and flex cables. Securely holds cable in place and releases quickly.

- Quickly splits the armored jacket on 14-2 to 10-4 armored cables and 3/8" flexible conduit with a few turns of the handle
- Adjustable cutting depth for standard and reduced diameter BX/MC cables
- Stores up to 6 extra blades in handle knob
- Durable die cast epoxy enameled construction

SPECIFICATIONS

| MODEL # | STOCK # | DESCRIPTION | WEIGHT | MIN OPENING | MAX OPENING | FLEX (TRADE SIZE) | AWG SOL OR MC RANGE |
|------------|----------|--|--------|---------------|-------------|-------------------|---------------------|
| RF-120A-WW | 66978740 | RF-120A-WW 1/2" - 3/4" Roto-Flex™ Cutter | | | | | |
| RF-170-WW | 66979040 | RF-170-WW Giant Roto-Flex™ Cutter | | | | | |
| RF-120A-WW | 1.25 lbs | 0.75" | 1.13" | 1/2" - 3/4" | 4/2 to 2/4 | | |
| RF-170-WW | 1.25 lbs | 0.82" | 1.13" | 1/2" - 1-1/2" | 4/2 to 2/4 | | |

HAND TOOLS
WOUNDED WARRIOR PROJECT®
LIMITED EDITION PRODUCTS

HAND TOOLS

ROTO-SPLIT® AND ROTO-FLEX™ STANDARD BLADE

B-102



The Southwire B-102 Standard Blade is the replacement blade for all Roto-Split® and Roto-Flex™ models. This is an essential when installing MC cable. The B-102 is the perfect backup blade for your Roto-Split® and Roto-Flex™ cutters. Great for the electrician. Proudly made in the USA.

- Sold in packs of 2
- Blade used to cut steel casing
- Replacement blade for all Roto-Split® and Roto-Flex™ models

SPECIFICATIONS

| MODEL # | STOCK # | DESCRIPTION | | |
|---------|----------|---|--------|----------|
| B-102 | 59814401 | Replacement Blade for RS-101A-WW, RS-101AC-WW, RF-120A-WW | | |
| MCBLADE | 58282340 | Replacement Blade for MCCUT-WW | | |
| | HEIGHT | WIDTH | DEPTH | WEIGHT |
| B-102 | 1.26" | 1.26" | 0.025" | .006 lbs |
| MCBLADE | 1.26" | 1.26" | 0.025" | .006 lbs |

TERMINATION

OFFSET TEETH BLADE

B-107



The Southwire B-107 is a heavy-duty, universal blade that can be used on all Roto-Flex™ tools. It cuts through aluminum armor clad with minimal effort. It can also cut through steel armor on 1/2" and larger trade size flex. Need a backup blade? This is a great replacement blade for aluminum casing. Perfect for the electrician. Proudly made in the USA.

- Offset teeth to prevent clogging
- Used to cut aluminum casing
- For use with all Roto-Flex™ models
- Not for use with the RS-101AC-WW

SPECIFICATIONS

| MODEL # | STOCK # | DESCRIPTION | | |
|---------|----------|---------------------------------|--------|----------|
| B-107 | 59814901 | Replacement Blade for RF-170-WW | | |
| | WEIGHT | HEIGHT | WIDTH | DEPTH |
| B-107 | 1.26" | 1.26" | 0.025" | .006 lbs |

HAND TOOLS

STRIP-ALL® STRIPPERS

SA-200SK



 **WE'VE GOT IT
MADE IN AMERICA™**

The SA-200SK is perfect for stripping flat cable. It is a very helpful tool that makes stripping cable faster. It can straight cut jacketed cables up to 5/8" and ring cut cables up to 1/2". Great for the electrician. The best part? This tool is proudly made in the USA.

- Extremely accurate
- Calibrated micrometer dial for precise depth of cut adjustment
- Handy, built-in wire stripper on all models
- Equipped with an extra-sharp, surgical type blade cartridge which easily slices through cable jackets

SPECIFICATIONS

| MODEL # | STOCK # | DESCRIPTION | WEIGHT | MIN OPENING | MAX OPENING | FLEX (TRADE SIZE) | AWG SOL OR MC RANGE |
|----------|----------|---|---------|-------------|-------------|-------------------|---------------------|
| SA-200SK | 59817340 | SA-200SK Strip-All® Stripper with Knife | .25 lbs | 1/4" | 5/8" | 5-1/4" | 4/0' |
| SA-200S | 59817201 | SA-200S Strip-All® Stripper without Knife | .25 lbs | 1/4" | 5/8" | 5-1/4" | 4/0' |
| SA-200L | 59817101 | SA-200L Large Strip-All® Stripper | .25 lbs | 3/8" | 7/8" | 5-1/4" | 14-2 to 6-3 |

VEE-TWIN™ STRIPPER

VT-270



 **WE'VE GOT IT
MADE IN AMERICA™**

The Vee-Twin™ Stripper makes it easy to strip difficult rubber cable as well as plastic jacket cables with its 90° rotating blade, which can be used for ring-cutting and straight-cutting. The VT-270 is perfect for precise cuts in thick cable. It is also great for stripping bulk amounts of cable. Proudly made in the USA.

- Depth of cut setting is extremely accurate to .001" due to a precision micrometer
- Useful for cable sizes ranging from 5/16" to 2-1/8" O.D.
- Used on entrance cable, plenum, multi-pair, and tray cables
- Strips plastic jackets from liquid-tight, flex, or MC
- Blade can be easily replaced
- Body is nickel plated steel for increased durability

SPECIFICATIONS

| MODEL # | STOCK # | DESCRIPTION | WEIGHT | MIN OPENING | MAX OPENING | MAX CUT DEPTH | AWG SOL OR MC RANGE |
|---------|----------|---------------------------|---------|-------------|-------------|---------------|---------------------|
| VT-270 | 59817701 | VT-270 Vee-Twin™ Stripper | 0.7 lbs | 5/16" | 2-1/8" | 1/4" | 14-2 to 4/0 |

HAND TOOLS

EDGEFORCE™ & STAINLESS STEEL KNIVES

UTILQ0



CDPK



HBKN



HBKND2



UTILAR



TBKND2-CAMO



CSPKD2



DPKD2



Our knives feature a durable 8CR13MOV stainless steel blade with a black oxide finish and liner lock that keeps the blade secure. Our compact pocket knife is perfect for everyday carry and our hawk bill knife is the perfect pocket knife for pull cuts and splicing.

- Corrosion resistant
- Liner lock keeps blade secure
- Dual thumb studs for right or left hand opening
- Comfort grip for maximum hold and comfort
- Edgeforce™ D2 steel

SPECIFICATIONS

| MODEL # | STOCK # | DESCRIPTION | HEIGHT | WIDTH | DEPTH | WEIGHT |
|-------------|----------|-------------------------------|--------|-------|-------|----------|
| UTILQ0 | 65029040 | Folding Utility Knife | 6.85" | 1.61" | 0.45" | 0.30 lbs |
| CDPK | 65029340 | Compact Pocket Knife | 6.74" | 1.05" | 0.45" | 0.10 lbs |
| HBKN | 65029440 | Hawkbill Folding Knife | 7.24" | 1.57" | 0.45" | 0.25 lbs |
| HBKND2 | 65029640 | EDGEFORCE™ Hawk Bill Knife | 7.24" | 1.57" | 0.45" | 0.25 lbs |
| UTILAR | 65029240 | Auto Retracting Utility Knife | 6.01" | 0.45" | 0.45" | 0.30 lbs |
| TBKND2-CAMO | 65029840 | EDGEFORCE™ Tanto Knife | 8.18" | 1.5" | 0.45" | 0.25 lbs |
| CSPKD2 | 65029740 | EDGEFORCE™ Sheepsfoot Knife | 7.28" | 1.05" | 0.79" | 0.23 lbs |
| DPKD2 | 65029540 | EDGEFORCE™ Drop Point Knife | 7.09" | 1.05" | 0.79" | 0.33 lbs |



HAND TOOLS

KEYSTONE TIP SCREWDRIVERS

SD1/4K4US



SD5/16K6US



Our USA keystone tip screwdrivers are constructed to handle the toughest jobs with ease. The cushion grip handles allow for maximum torque and comfort. These screwdrivers come with high quality, precision machined tips for an exact fit.

- 22% Larger cushion grip handle provides ultimate comfort and maximum torque
- Corrosion resistant shank
- Tether hole for tether or lanyard attachment
- No-hassle lifetime warranty



SPECIFICATIONS

| MODEL # | STOCK # | DESCRIPTION | | |
|------------|------------|--------------------------------|----------|----------|
| SD1/4K4US | 65139240 | 1/4" Keystone Tip Screwdriver | | |
| SD5/16K6US | 65139340 | 5/16" Keystone Tip Screwdriver | | |
| | HEIGHT | WIDTH | DEPTH | WEIGHT |
| SD1/4K4US | 9" | 1.35" | 1.1" | 0.30 lbs |
| SD5/16K6US | 9" | 1.35" | 1.1" | 0.45 lbs |
| | SHANK TYPE | SHANK LENGTH | TIP TYPE | |
| SD1/4K4US | Round | 4" | Keystone | |
| SD5/16K6US | Round | 6" | Keystone | |



HAND TOOLS

CABINET TIP SCREWDRIVERS

SD1/4C4US



SD1/4C6US



SD3/16C4US



SD3/16C6US



SD3/16C8US



**WE'VE GOT IT
MADE IN AMERICA™**

Our USA cabinet tip screwdrivers are constructed to handle the toughest jobs with ease. The cushion grip handles allow for maximum torque and comfort. These screwdrivers come with high quality, precision machined tips for an exact fit.

- 22% Larger cushion grip handle provides ultimate comfort and maximum torque
- Corrosion resistant shank
- Tether hole for tether or lanyard attachment
- No-hassle lifetime warranty

SPECIFICATIONS

| MODEL # | STOCK # | DESCRIPTION | | | |
|------------|----------|-------------------------------|--------------|----------|----------|
| SD1/4C4US | 65138740 | 1/4" Cabinet Tip Screwdriver | | | |
| SD1/4C6US | 65138840 | 1/4" Cabinet Tip Screwdriver | | | |
| SD3/16C4US | 65138940 | 3/16" Cabinet Tip Screwdriver | | | |
| SD3/16C6US | 65139040 | 3/16" Cabinet Tip Screwdriver | | | |
| SD3/16C8US | 65139140 | 3/16" Cabinet Tip Screwdriver | | | |
| | | HEIGHT | WIDTH | DEPTH | WEIGHT |
| SD1/4C4US | | 8.5" | 1.35" | 1.35" | 0.30 lbs |
| SD1/4C6US | | 10.5" | 1.35" | 1.35" | 0.35 lbs |
| SD3/16C4US | | 8.5" | 1.28" | 1.35" | 0.20 lbs |
| SD3/16C6US | | 10.5" | 1.28" | 1.35" | 0.20 lbs |
| SD3/16C8US | | 12.5" | 1.28" | 1.35" | 0.20 lbs |
| | | SHANK TYPE | SHANK LENGTH | TIP TYPE | |
| SD1/4C4US | | Round | 4" | Cabinet | |
| SD1/4C6US | | Round | 6" | Cabinet | |
| SD3/16C4US | | Round | 4" | Cabinet | |
| SD3/16C6US | | Round | 6" | Cabinet | |
| SD3/16C8US | | Round | 8" | Cabinet | |



HAND TOOLS

PHILLIPS TIP SCREWDRIVERS

SD1P3US



SD2P4US



SD2P6US



Our USA Phillip tip screwdrivers are constructed to handle the toughest jobs with ease. The cushion grip handles allow for maximum torque and comfort. These screwdrivers come with high quality, precision machined tips for an exact fit.

- 22% Larger cushion grip handle provides ultimate comfort and maximum torque
- Corrosion resistant shank
- Tether hole for tether or lanyard attachment
- No-hassle lifetime warranty

SPECIFICATIONS

| MODEL # | STOCK # | DESCRIPTION | HEIGHT | WIDTH | DEPTH | WEIGHT |
|---------|----------|------------------------------|--------------|-------------|-------|----------|
| SD1P3US | 65139440 | #1 Phillips Head Screwdriver | 8.5" | 1.28" | 1.35" | 0.25 lbs |
| SD2P4US | 65139540 | #2 Phillips Head Screwdriver | 9" | 1.35" | 1.35" | 0.30 lbs |
| SD2P6US | 65139640 | #2 Phillips Head Screwdriver | 14" | 1.35" | 1.35" | 0.05 lbs |
| | | SHANK TYPE | SHANK LENGTH | TIP TYPE | | |
| SD1P3US | | Round | 3" | #1 Phillips | | |
| SD2P4US | | Round | 4" | #2 Phillips | | |
| SD2P6US | | Round | 6" | #2 Phillips | | |



HAND TOOLS | DRIVERS



HAND TOOLS

SQUARE TIP SCREWDRIVER

SDQ2P4US



The USA #2 square tip driver has a 22% larger cushion grip handle that provides ultimate comfort and maximum torque *as compared to previous generations. The corrosion resistant shank ensures durability to withstand rust, allowing for a longer life. This screwdriver comes with a high quality, precision machined tip for an exact fit. A tether hole is provided for tether/lanyard attachment for added convenience. Patent pending.

- 22% Larger cushion grip handle provides ultimate comfort and maximum torque
- Corrosion resistant shank
- Tether hole for tether or lanyard attachment
- No-hassle lifetime warranty

SPECIFICATIONS

| MODEL # | STOCK # | DESCRIPTION | | |
|----------|------------|---------------------------|--------------|----------|
| SDQ2P4US | 58281640 | #2 Square Tip Screwdriver | | |
| | HEIGHT | WIDTH | DEPTH | WEIGHT |
| SDQ2P4US | 8.5" | 1.35" | 1.35" | 0.35 lbs |
| | SHANK TYPE | | SHANK LENGTH | TIP TYPE |
| SDQ2P4US | Square | | 4" | Square |

 WE'VE GOT IT
MADE IN AMERICA™

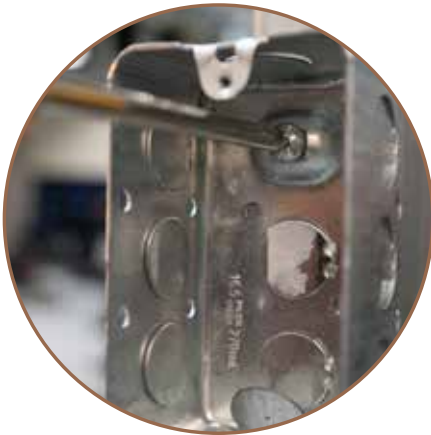

HAND TOOLS | DRIVERS

HAND TOOLS

8-PIECE CUSHION GRIP SCREWDRIVER SET



SDSET8US

All-purpose assortment of frequently used screwdrivers.

- Comfortable cushion grip handle offers slip resistance and greater torque
- Precision tips for an exact fit
- Handles marked for easy identification
- Includes 8 pieces: 3/16" x 4", 3/16" x 6" and 1/4" x 4" slotted tip, 1/4" x 4" and 5/16" x 6" keystone tip, #1 x 3", #2 x 4", Phillips tip, and #2 x 4" square tipped screwdrivers

3-PIECE INSULATED SCREWDRIVER SET

SDISET3

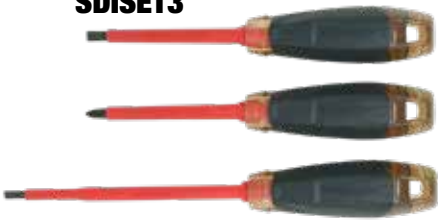

This screwdriver set comes with 3 insulated drivers that are tested to the ASTM F1505 international standard and provide 1000 volt insulated protection.

- 1000 volt insulated protection
- Tested to ASTM F1505 international standard
- Durable molded insulation offers visual wear indication
- Includes #2 Phillips x 4" shank, 1/4" slotted x 4" shank, and 3/16" slotted x 6" shank

| MODEL # | STOCK # | DESCRIPTION | HEIGHT | WIDTH | DEPTH | WEIGHT | INCLUDES |
|----------|----------|--------------------------------------|--------|-------|-------|----------|--|
| SDSET8US | 65139940 | 8-Piece Cushion Grip Screwdriver Set | 8.5" | 1.25" | 1.25" | 0.13 lbs | SD3/16C4, SD3/16C6, SD1/4K4HD, SD1/4C4, SD5/16K6HD, SD1P3, SD2P4HD, SDQ2P4 |
| SDISET3 | 65172040 | 3 Piece Insulated Screwdriver Set | 9" | 1.35" | 1.35" | 0.13 lbs | #2 Phillips x 4" shank, 1/4" Slotted x 4" shank, 3/16" Slotted x 6" shank |



CONDUIT FITTING REAMING SCREWDRIVER

SDCFR



Removable conduit reaming screwdriver deburs thin wall conduit with speed and ease.

- Reams and smooths 1/2", 3/4", and 1" thin-wall conduit ends to protect wire and permit correct installation of fittings
- Reams inside and outside of conduit simultaneously
- Cushion grip handles for comfort and use
- Detachable head can also be used in a drill

SPECIFICATIONS

| MODEL # | STOCK # | DESCRIPTION | | |
|---------|----------|-------------------------------------|-------|----------|
| SDCFR | 58283740 | Conduit Fitting Reaming Screwdriver | | |
| | HEIGHT | WIDTH | DEPTH | WEIGHT |
| SDCFR | 7.5" | 1.25" | 1.25" | 0.59 lbs |

HAND TOOLS

MULTI-BIT/ADJUSTABLE/ROTARY SCREWDRIVERS

SD4N1C



SD4N1P



SD6N1P



SD9N1



SD2N1AL



SD4N1C

- Rotary action screwdrivers facilitate fast and easy screw installation and removal.
- Magnetic bit holder
- Chrome plated finish for corrosion resistance
- Heavy Duty steel shanks with bolsters for wrench assisted turning

SD4N1P

- Precision screwdrivers make work in small spaces easier.
- Includes: 1/8" and 3/32" slotted, #0 and #00 phillips
- Spinning cap for controlled one handed use
- Patent pending cushion grip handle

SD6N1P

- Comes with a precision bit allowing easier work in small spaces.
- #0 Phillips bit for precision work
- Chrome plated finish for corrosion resistance
- Comfort grip handle provides extra comfort and maximum torque

SD9N1

- Convenient multi-tool screwdriver with nine tools in one.
- Comfortable cushioned grip allows firm grip and greater torque.
- Precision-machined tips reduce slipping
- Integral flanges provide a solid, twist-resistant blade anchor

SD2N1AL

- Allows for extending and shortening of the shank for work in different places
- Adjustable from 4" to 8"
- Pull collar down to extend shank and pull up to shorten
- Zinc plated finish for corrosion resistance

SPECIFICATIONS

| MODEL # | STOCK # | DESCRIPTION | HEIGHT | WIDTH | DEPTH | WEIGHT |
|----------|----------|---|--------|-------|-------|----------|
| SD4N1C | 65028540 | 4-in-1 Magnetic Rotary Driver | 9.30" | 1.28" | 1.38" | 0.75 lbs |
| SD4N1P | 65117240 | 4-in-1 Magnetic Screwdriver w/ Precision Bit | 7.99" | 0.67" | 0.39" | 0.16 lbs |
| SD6N1P | 65028840 | 6-in-1 Screwdriver w/ Precision Bit | 11.06" | 1.28" | 1.30" | 0.60 lbs |
| SD9N1 | 58285640 | 9-in-1 Multi Tool Screwdriver | 11.02" | 1.25" | 1.57" | 0.55 lbs |
| SD2N1AL | 65028640 | 2-in-1 Adjustable Length Screwdriver | 11.02" | 1.2" | 1.57" | 0.75 lbs |
| TIP TYPE | | | | | | |
| SD4N1C | | #1 & #2 Phillips, 3/16" & 1/4" Slotted | | | | |
| SD4N1P | | 1/8" and 3/32" slotted, #0 and #00 phillips | | | | |
| SD6N1P | | 5/16" & 1/4" nut drivers, #1 & #0 Phillips, 1/4" & 3/16" Slotted | | | | |
| SD9N1 | | 1/4", 3/8", & 5/16" Hex, #1 & #2 Phillips, 1/4" & 3/16" Slotted, #1 & #2 Square | | | | |
| SD2N1AL | | #2 Phillips, 1/4" Slotted | | | | |



12-IN-1 MULTI-BIT SCREWDRIVER



The 12-in-1 multi-bit screwdriver has precision-machined, quick change bits.

- Precision-machined, quick change bits for driving hex, Phillips, slotted, and square head screws
- Handles 3/16", 1/4", 5/16" slotted; #1, #2, #3 Phillips; #1, #2, square recessed; and 1/4", 5/16", 3/8", 1/2" hex drive
- Cushion grip handle provides extra comfort and maximum torque
- Premium chrome-plated shaft is durable as well as rust and corrosion resistant
- Meets ANSI/ASME specifications

SPECIFICATIONS

| MODEL # | STOCK # | DESCRIPTION | | |
|---------|----------|-------------------------------|--------|----------|
| SD12N1 | 59723940 | 12-in-1 Multi-Bit Screwdriver | | |
| HEIGHT | WIDTH | DEPTH | WEIGHT | |
| SD12N1 | 11.75" | 3.25" | 1.38" | 0.85 lbs |

9-IN-1 RATCHETING SCREWDRIVER



The 9-in-1 ratcheting multi-tool screwdriver allows for quick driving of screws and nuts.

- Precision-machined, quick change bits for driving hex, Phillips, slotted, and square head screws
- Handles 1/4", 3/8", 5/16" hex; #1 and #2 Phillips; 1/2" and 3/16" slotted; #1 and #2 square
- Cushion grip handle provides extra comfort and maximum torque
- Premium chrome-plated shaft is durable as well as rust and corrosion resistant
- Meets ANSI/ASME specifications

SPECIFICATIONS

| MODEL # | STOCK # | DESCRIPTION | | |
|---------|----------|-------------------------------|--------|---------|
| SDR9N1 | 59724040 | 9-in-1 Ratcheting Screwdriver | | |
| HEIGHT | WIDTH | DEPTH | WEIGHT | |
| SDR9N1 | 11.75" | 3.25" | 1.50" | 0.6 lbs |

HAND TOOLS

6-IN-1 STUBBY MULTIBIT SCREWDRIVER

SDS6N1



The 6-in-1 multi-bit screwdriver features precision-machined, quick change bits.

- Includes 2 double sided screwdriver bits and 1 double sided nut driver
- Sizes include 5/16" & 1/2" hex, #1 & #2 Phillips, & 3/16" & 1/4" slotted tips
- Cushion grip handles for added comfort and improved torque

SPECIFICATIONS

| MODEL # | STOCK # | DESCRIPTION | | |
|---------|----------|-------------------------------------|-------|---------|
| SDS6N1 | 58739740 | 6-in-1 Stubby Multi-Bit Screwdriver | | |
| | HEIGHT | WIDTH | DEPTH | WEIGHT |
| SDS6N1 | 3.50" | 1.25" | 1.25" | .20 lbs |

HAND TOOLS

NUT DRIVERS

ND7/16-3US



ND1/2-3US



ND1/4-3US



ND3/8-3US



ND11/32-3US



ND3/16-3US



ND5/16-3US



**WE'VE GOT IT
MADE IN AMERICA™**

ND6N1HD



NDS5N1



This line of USA nut drivers includes a 7 piece set. The nut drivers have 22% larger cushion grip handles that provides ultimate comfort and maximum torque *as compared to previous generations. The corrosion resistant shank ensures durability to withstand damage, allowing for a longer life. A tether hole is provided for tether/lanyard attachment for added convenience. Patent pending.

- 22% Larger cushion grip handle provides ultimate comfort and maximum torque
- Corrosion resistant shank
- Tether hole for tether or lanyard attachment
- No-hassle lifetime warranty

SPECIFICATIONS

| MODEL # | STOCK # | DESCRIPTION | | | | | |
|-------------|----------|------------------------------|------------|--------------|----------|---|--------------|
| ND7/16-3US | 65138340 | 7/16" Nut Driver | | | | | |
| ND1/2-3US | 65137840 | 1/2" Nut Driver | | | | | |
| ND1/4-3US | 65137940 | 1/4" Nut Driver | | | | | |
| ND3/8-3US | 65138140 | 3/8" Nut Driver | | | | | |
| ND11/32-3US | 65138540 | 11/32" Nut Driver | | | | | |
| ND3/16-3US | 65138440 | 3/16" Nut Driver | | | | | |
| ND5/16-3US | 65138240 | 5/16" Nut Driver | | | | | |
| ND6N1HD | 65028740 | 6-in-1 Heavy Duty Nut Driver | | | | | |
| NDS5N1 | 65116540 | 5-in-1 Stubby Nut Driver | | | | | |
| NDSET7US | 65138640 | 7 Piece Nut Driver Set | | | | | |
| | | | HEIGHT | WIDTH | DEPTH | WEIGHT | SHANK LENGTH |
| ND7/16-3US | | | 8" | 1.35" | 1.2" | 0.35 lbs | 3" |
| ND1/2-3US | | | 8" | 1.35" | 1.2" | 0.40 lbs | 3" |
| ND1/4-3US | | | 8" | 1.28" | 1.2" | 0.25 lbs | 3" |
| ND3/8-3US | | | 8" | 1.28" | 1.2" | 0.30 lbs | 3" |
| ND11/32-3US | | | 8" | 1.28" | 1.2" | 0.30 lbs | 3" |
| ND3/16-3US | | | 8" | 1.28" | 1.2" | 0.25 lbs | 3" |
| ND5/16-3US | | | 8" | 1.28" | 1.2" | 0.30 lbs | 3" |
| ND6N1HD | | | 11.42" | 1.25" | 1.77" | 1.00 lbs | - |
| NDS5N1 | | | 5.91" | 1.77" | 1.18" | 0.28 lbs | - |
| NDSET7US | | | 6" | 1.40" | 1.18" | 2.00 lbs | - |
| | | | SHANK TYPE | SHANK LENGTH | TIP TYPE | | |
| ND7/16-3US | | | Round | | 3" | 7/16" | |
| ND1/2-3US | | | Round | | 3" | 1/2" | |
| ND1/4-3US | | | Round | | 3" | 1/4" | |
| ND3/8-3US | | | Round | | 3" | 3/8" | |
| ND11/32-3US | | | Round | | 3" | 11/32" | |
| ND3/16-3US | | | Round | | 3" | 3/16" | |
| ND5/16-3US | | | Round | | 3" | 5/16" | |
| ND6N1HD | | | - | | - | 3/16", 1/4", 5/16", 3/8", 7/16", 9/16" | |
| NDS5N1 | | | - | | - | 3/16", 1/4", 5/16", 3/8", 1/2" | |
| NDSET7US | | | - | | - | 1/2", 1/4", 3/8", 5/16", 7/16", 3/16", and 11/32" | |



HAND TOOLS | DRIVERS

HAND TOOLS

T-HANDLE HEX KEYS



Designed to efficiently tighten and loosen hex screws.

- T-handle design allows for greater torque application
- Hex key blade - long and short for flexible use
- Forged heavy duty steel blade for durable usage
- Over molded grip for comfortable feel

SPECIFICATIONS

| MODEL # | STOCK # | DESCRIPTION | | | |
|-----------|----------|-----------------------------------|--------|------------|----|
| THEX6-1/2 | 58287840 | 1/2" T-Handle Hex Key w/ 8" Shank | | | |
| HEIGHT | WIDTH | DEPTH | WEIGHT | SET LENGTH | |
| THEX6-1/2 | 9.75" | 4.75" | 1" | 0.91 lbs | 8" |

FOLDING HEX KEY SETS



Convenient and reliable, these folding hex key sets will help you get the job done quickly and easily.

- Precision made hex keys reduce slipping and stripping
- Set easily stores in metal case to reduce lost keys and damage
- Strong durable body doubles as a handle



SPECIFICATIONS

| MODEL # | STOCK # | DESCRIPTION | | | |
|---------|----------|-----------------------------|--------|------------|--|
| HEX-8 | 58287640 | 8-Piece Folding Hex Key Set | | | |
| HEX-5 | 58287540 | 5-Piece Folding Hex Key Set | | | |
| HEIGHT | WIDTH | DEPTH | WEIGHT | SET LENGTH | |
| HEX-5 | 5.25" | 1.5" | 0.75" | 0.68 lbs | 3/32", 7/64", 1/8", 9/64", 5/32", 3/16", 7/32", & 1/4" |
| HEX-8 | 5.25" | 1.5" | 0.75" | 0.89 lbs | 3/16", 7/32", 1/4", 5/16", & 3/8" |

CONDUIT BENDING LEVEL

MCBLEVEL



High visibility vials are easy to read and set for measurements at 0°, 30°, 45°, and 90°.

- Set screw secures level to conduit
- Four powerful magnets for hands free operation
- Easy-to-read, high impact, acrylic bubble vials
- V-grooved edge helps hold the level in place on pipe or conduit

SPECIFICATIONS

| MODEL # | STOCK # | DESCRIPTION | | | |
|----------|----------|--------------------------|--------|--------------|---|
| MCBLEVEL | 58281640 | 6" Conduit Bending Level | | | |
| HEIGHT | WIDTH | DEPTH | WEIGHT | SET INCLUDES | |
| MCBLEVEL | 6.31" | 1.88" | 0.63" | 0.31 lbs | Magnets, thumb screw for attaching to conduit |

HAND TOOLS

ELECTRICIAN'S SHOULDER POUCH

BAGESP



Convenient shoulder bag provides a lightweight, durable tool carrier that can be hand-carried, slung over your shoulder, or attached to a belt. Features 16 storage pockets.

- Multiple carrying options: shoulder strap, padded handle, belt loop tunnel
- Constructed from 2400D ballistic weave for durability
- 16 tool storage pockets

SPECIFICATIONS

| MODEL # | STOCK # | DESCRIPTION | | |
|---------|----------|------------------------------|-------------------|---------------------------|
| BAGESP | 58738740 | Electrician's Shoulder Pouch | | |
| HEIGHT | WIDTH | DEPTH | INTERNAL CAPACITY | |
| BAGESP | 12" | 8.5" | 6.5" | 247 Cubic Inches/4 Liters |

TOOL BACKPACK

PROBAGBP



Our tool backpack allows you to comfortably carry your tools on your back or by hand. Easy opening zippers allow access to the numerous tool storage compartments. Enclosed pouches are located on both external and internal surfaces to provide additional tool storage security.

- Constructed from 2400D ballistic weave for durability
- 58 storage pockets, zippered pouches, and tool loops
- Non-tipping rubber base is wear and water resistant
- Fully molded base allows bag to stand freely

SPECIFICATIONS

| MODEL # | STOCK # | DESCRIPTION | | |
|----------|----------|---------------|-------------------|---------------------|
| PROBAGBP | 67599040 | Tool Backpack | | |
| HEIGHT | WIDTH | DEPTH | INTERNAL CAPACITY | |
| PROBAGBP | 18.7" | 13.78" | 7.87" | 1, 235 Cubic Inches |

HAND TOOLS

5-POCKET LEATHER TOOL POUCH

POUCH4



The 5-pocket leather tool pouch with electrical tape chain is designed for easy storage and tool access.

- Saddle leather resistant to fade and stain
- Washer rivets for extra strength
- Fits belts up to 3" wide

SPECIFICATIONS

| MODEL # | STOCK # | DESCRIPTION | | |
|---------|----------|----------------------|-------|-------------------|
| POUCH4 | 58283140 | 5 Pocket Tool Pouch* | | |
| | HEIGHT | WIDTH | DEPTH | INTERNAL CAPACITY |
| POUCH4 | 9.25" | 7" | 3" | Leather |

**tools not included.*

ELECTRICIAN'S WORK GLOVES

GLOVE1L



High dexterity electrician's gloves with anti-slip fingertips.

- Anti-slip finger tips for secure holding of wire and tools
- Padded palm for protection and secure grip
- Wrapped index finger for durability
- Breathable spandex back for comfortable fit and feel
- Touchscreen compatible index finger and thumb

SPECIFICATIONS

| MODEL # | STOCK # | DESCRIPTION |
|------------------|--------------------|-----------------------------------|
| GLOVE1L | 58739040 | Electrician's Work Gloves - Large |
| PRIMARY MATERIAL | | SECONDARY MATERIAL |
| GLOVE1L | Breathable Spandex | Synthetic Leather |



HAND TOOLS

CANVAS ZIPPER BAG

BAG12



Our canvas zipper bag is a very convenient storage place for pliers, wrenches, and other tools that you use daily.

BAG12

- Durable, heavy-duty cotton canvas bag
- Sturdy plastic resin zipper

BAG4P

- 4-Pack of durable polyester bags with sturdy resin zipper
- Perfect for storing Pliers, screwdrivers, staples or electrical connectors.

BAG4P



SPECIFICATIONS

| MODEL # | STOCK # | DESCRIPTION | | |
|---------|----------|-------------------------------|-------|----------|
| BAG12 | 58282840 | 12" Canvas Zipper Bag | | |
| BAG4P | 59724140 | Polyester Zippered Bag 4-Pack | | |
| | HEIGHT | WIDTH | DEPTH | WEIGHT |
| BAG12 | 7" | 12" | 0.25" | 0.13 lbs |
| BAG4P | 7" | 11.5" | 1.00" | 0.35 lbs |

4-PIECE ELECTRICIAN'S TOOL KIT

EKIT-4



Complete with 10-18 AWG wire stripper, 9-in-1 multi-bit screwdriver, high leverage side cutting pliers, and nylon carrying pouch.

10-18 AWG WIRE STRIPPER - MODEL # S1018STR

- Strips and cuts 10-18 AWG solid and 12-20 AWG stranded wire
- Stainless steel construction is durable and corrosion resistant
- Double-dipped grip provides comfortable fit
- Specially designed stainless steel cutting blades provide fast and clean wire stripping
- Serrated nose grasps the cable for easy twisting and pulling
- Spring loaded for self-opening action
- Not intended for cutting bolts or steel cable

HIGH LEVERAGE SIDE CUTTING PLIERS - MODEL # SCP9

- Induction hardened cutting blades ensure efficient and lasting cutting surfaces for hard and soft wire
- File teeth on jaws help remove burrs in conduit
- Cuts ACSR, screws, nails, and most hardened wire
- Curved handle and ergonomic molded grip for comfortable use
- Drop forged CRV steel for durability

9-IN-1 MULTI-BIT SCREWDRIVER - MODEL # SD9N1

- Includes 6 bits and 3 nut drivers for multi-purpose use
- Cushion grip handle for comfortable use and maximum torque application

SPECIFICATIONS

| MODEL # | STOCK # | DESCRIPTION | | | |
|---------|----------|--------------------------------|-------|----------|---------------------------|
| EKIT-4 | 59158740 | 4-Piece Electrician's Tool Kit | | | |
| | HEIGHT | WIDTH | DEPTH | WEIGHT | INCLUDES |
| EKIT-4 | 9.75" | 4.25" | 2.25" | 0.35 lbs | S1018STR, SCP9, and SD9N1 |

HAND TOOLS

CABLE SPLICERS KIT

CSK5



Cable splicers kit is ideal for prepping category cable installation.

- Lock holds blades closed for storage
- Serrated lower blades grip wire for non-slip cutting action
- Includes marking pen
- Includes leather carrying pouch
- Includes boot knife for sheathing and removing cable jackets

SPECIFICATIONS

| MODEL # | STOCK # | DESCRIPTION | | |
|---------|----------|--------------------|--------|---------|
| CSK5 | 59724240 | Cable Splicers Kit | | |
| HEIGHT | WIDTH | DEPTH | WEIGHT | |
| CSK5 | 8.25" | 3.8" | 2.2" | 0.8 lb. |



BASIC ELECTRICIAN'S KIT

BEKIT-3



The perfect start to your electrical work tool box. These three tools are exactly what you need to get started on any simple electrical task.

- The S1018STR stainless steel wire stripper is rust resistant
- The SD9N1 Multi-Bit Screwdriver includes #1 & #2 Phillips tips, 1/4", 5/16", & 3/8" hex drivers, 3/16" & 1/4" slotted tips, and #1 & #2 square tips
- The 40116N NCV has a detection range of 100-600V AC

SPECIFICATIONS

| MODEL # | STOCK # | DESCRIPTION | | |
|---------|----------|-------------------------|--------|-------|
| BEKIT-3 | 63136840 | Basic Electrician's Kit | | |
| HEIGHT | WIDTH | DEPTH | WEIGHT | |
| BEKIT-3 | 10.25" | 7.88" | 0.75" | 2 lbs |

VOICE DATA VIDEO

Southwire offers a full line of VDV tools including cable cutters, strippers, crimpers and punchdown tools, as well as cable tracers and testers. Our goal is to provide professional tools that exceed customers' expectations for quality, performance and features — tools that make a difference on the real-world jobsite.



VDV HAND TOOLS

PROFESSIONAL DATACOMM SNIPS

ESP-1



These snips provide very precise control and offer a patented design with unique spring-loaded action.

- Ergonomic, spring-loaded design for precise control
- Lock holds snips closed for storage
- Double-dipped, textured grip
- Strips 19 AWG and 23 AWG
- Serrated blade grips wire as it cuts

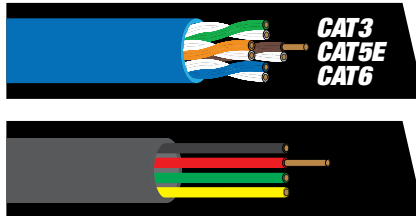

SPECIFICATIONS

| MODEL # | STOCK # | DESCRIPTION |
|---------|----------|-----------------------------|
| ESP-1 | 58743740 | Professional DataComm Snips |

VDV HAND TOOLS

ELECTRICIAN'S SCISSORS

ESS-1



Unlike regular scissors or shears, the serrated blades of this powerful scissor keeps wire from slipping out of the jaws. Cutting through hardware cloth, cable, wire netting, and other difficult-to-cut materials becomes as easy task.

- Strips 19 AWG & 23 AWG
- Strong, tempered steel
- Nickel-plated finish resists corrosion
- Scraper and file on outside of both blades



SPECIFICATIONS

| MODEL # | STOCK # | DESCRIPTION |
|---------|---------|-------------|
|---------|---------|-------------|

| | | |
|-------|----------|------------------------|
| ESS-1 | 58743840 | Electrician's Scissors |
|-------|----------|------------------------|

VDV HAND TOOLS

COAX CCS CUTTER

CCSX-C1



Many coax cables today have a copper clad steel (CCS) center conductor. This specially designed cutter is made to reliably cut CCS coax that might damage standard cable cutters.

- Reliably cuts copper-clad steel coax without blade damage
- V-notch blade doesn't deform cable
- Forged steel
- Double-dipped textured grip

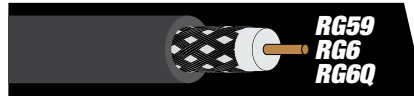

SPECIFICATIONS

| MODEL # | STOCK # | DESCRIPTION |
|---------|----------|-------------------------|
| CCSX-C1 | 58743340 | CCSX-C1 Coax CCS Cutter |

ROUND CABLE CUTTER

X-C1



The stainless steel X-C1 has two cable cutting profiles: a long nose for cutting in confined spaces and a cable tie cutting tip. This is perfect for coax and twisted pair cabling.

- Curved blade profile for clean cuts
- Elongated nose to reach and cut in tight places
- Stainless steel for corrosion resistance
- Double-dipped textured grip
- Cutting areas for small and large round cable

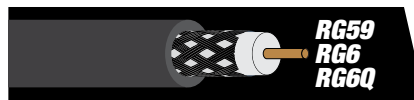

SPECIFICATIONS

| MODEL # | STOCK # | DESCRIPTION |
|---------|----------|-------------------------|
| X-C1 | 58746740 | X-C1 Round Cable Cutter |

VDV HAND TOOLS

KEY STRIP TOOL FOR TWISTED PAIR

SK-T1



The key strip tool for twisted pair quickly strips outer cable jackets from CAT 3, 5, 5e and 6 data cable.

- Quickly removes outer cable jacket
- Three positions for different size cables
- Cost effective



SPECIFICATIONS

| MODEL # | STOCK # | DESCRIPTION |
|---------|----------|---------------------------------------|
| SK-T1 | 58746140 | SK-T1 Key Strip Tool for Twisted Pair |

COAX TRIGGER STRIP TOOL

ST-C1



The rotary-style coax stripper performs a fast and precise two-level strip in one easy step.

- Standard two-level strip exposes 1/4" of center conductor and 1/4" of shield braid
- Innovative "trigger" design improves control and fits comfortably in hand
- Use with RG59, RG6 and RG6 quad shield coax

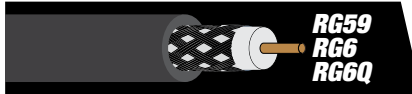

SPECIFICATIONS

| MODEL # | STOCK # | DESCRIPTION |
|---------|----------|-------------------------|
| ST-C1 | 58746240 | Coax Trigger Strip Tool |

VDV HAND TOOLS

AUTOMATIC WIRE STRIPPER FOR COAX

SA-C1



The SA-C1 automatic wire stripper for coax allows for quick, two-step stripping of RG6 and RG6Q cable.

- Traditional automatic design preferred by many installers
- 2-level strip: Center conductor and outer jacket

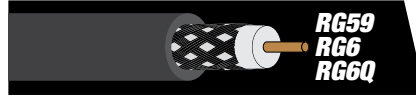

SPECIFICATIONS

| MODEL # | STOCK # | DESCRIPTION |
|---------|----------|----------------------------------|
| SA-C1 | 58745940 | Automatic Wire Stripper for Coax |

COAX CUTTER/STRIPPER

XS-C1



The XS-C1 coax cutter/stripper cuts and strips coax cable and features a cable tie cutting tip.

- Cuts and strips RG59, RG6, and RG6Q quad shield coax
- Stainless steel for corrosion resistance
- Textured double dip handles for better grip and comfort
- Tip is designed to cleanly cut cable ties

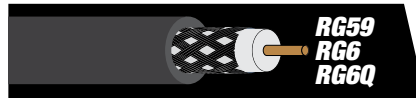

SPECIFICATIONS

| MODEL # | STOCK # | DESCRIPTION |
|---------|----------|----------------------|
| XS-C1 | 58746840 | Coax Cutter/Stripper |

VDV HAND TOOLS

COAX PREP TOOL

CPT-CF1



The time-saving coax prep tool is a 3-in-1 tool for loosening/tightening cable TV "F" connectors from jacks. It also flares the cable jacket and holds the connector during assembly.

- Easily loosens stubborn connectors
- Flares coax jacket for easy connector insertion
- Holds cable TV "F" connector during cable insertion
- Double-molded grip for long-lasting comfort

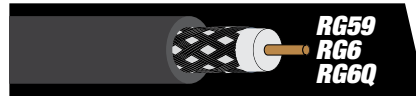

SPECIFICATIONS

| MODEL # | STOCK # | DESCRIPTION |
|---------|---------|-------------|
|---------|---------|-------------|

| | | |
|---------|----------|----------------|
| CPT-CF1 | 58743440 | Coax Prep Tool |
|---------|----------|----------------|

VDV HAND TOOLS

PROFESSIONAL IMPACT PUNCHDOWN TOOL

PDTP-K1



Includes both 110 and 66 style blades
Easy to pull out wire hook and spudger tools

The professional impact punchdown tool includes 110 & 66 twist-to-lock blades and features unique pull out accessory tools in a comfortable, durable tool body.

- Terminates twisted pair category cable into wall jacks and patch panels for phone and data communications
- Includes both 110 and 66-style, long life, metal injection molded blades
- Comfortable double-molded tool body
- Wire hook and spudger accessory tools pull out one-handed with easy-to-use thumb studs
- Covered blade storage

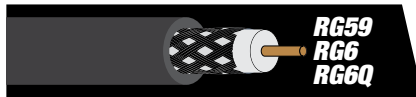

BLADES AVAILABLE SEPARATELY

- B1 Reversible 66 Punch/110 Cut-Only Punchdown Blade
- B2 Reversible 110 Cut/Punch Punchdown Blade
- B3 Reversible 66 Cut/Punch Punchdown Blade

SPECIFICATIONS

| MODEL # | STOCK # | DESCRIPTION |
|---------|----------|------------------------------------|
| PDTP-K1 | 58745540 | Professional Impact Punchdown Tool |

COMFORT GRIP 110-STYLE PUNCHDOWN TOOL

PDTC-1



The comfort grip 110-style punchdown tool easily terminates 110-style blocks on patch panels and wall jacks.

- Punch down 110-style jacks or patch panels
- Soft rubber comfort grip
- 110-style blade terminates cable and trims excess wire



SPECIFICATIONS

| MODEL # | STOCK # | DESCRIPTION |
|---------|----------|---------------------------------------|
| PDTC-1 | 58745440 | Comfort Grip 110-Style Punchdown Tool |

VDV HAND TOOLS

RATCHETING PHONE & DATA CRIMP TOOL

RJCR-T1



The RJCR-T1 ratcheting phone & data crimp tool cuts and strips voice and data cable. It also crimps RJ45 data connectors as well as RJ11/RJ12 phone modular plugs.

- Ratcheting tool cuts, strips, and crimps phone and data cable
- Comfortable double-molded grips help to orient the tool
- Compatible with standard RJ45, RJ11/RJ12, and RJ22 modular plugs
- Locks closed for easy storage

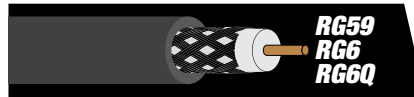

SPECIFICATIONS

| MODEL # | STOCK # | DESCRIPTION |
|---------|---------|-------------|
|---------|---------|-------------|

| | | |
|---------|----------|------------------------------------|
| RJCR-T1 | 58745840 | Ratcheting Phone & Data Crimp Tool |
|---------|----------|------------------------------------|

VDV HAND TOOLS

RATCHET CRIMP TOOL – COAX CABLE TV "F" HEX CONNECTORS

RCT-D1



The compound leverage design delivers high crimp force with low hand force, and the near-parallel jaw action delivers precision crimps. The RCT-D1 is where power meets precision.

- Compound leverage design provides powerful crimping with low hand force
- Near-parallel travel crimping jaw for precise crimps
- Precision ratchet with release
- Convenient handle lock for easy storage
- Die set available separately:
 - D1 Die Set - Cable TV F Coax

SPECIFICATIONS

| MODEL # | STOCK # | DESCRIPTION |
|---------|----------|----------------------------------|
| RCT-D1 | 58745640 | RCT-C1 Ratchet Crimp Tool – Coax |

VDV HAND TOOLS

NETWORK TOOL KIT

KIT-TP1



This 13-piece network tool kit includes the tools you need to cut, strip, terminate, and install data cabling.

- Complete 13 piece kit for terminating data cable
- Make custom length patch cables
- Includes tools to cut, strip, and terminate data cabling
- Kit includes:
 - Compact 3-in-1 Cut/Strip/Crimp Tool
 - Comfort Grip Punchdown Tool
 - Reversible Screwdriver
 - 10 RJ45 Connectors
 - Rugged Tool Case



SPECIFICATIONS

| MODEL # | STOCK # | DESCRIPTION |
|---------|----------|------------------|
| KIT-TP1 | 58744140 | Network Tool Kit |

CRIMPING LONG NOSE PLIERS – UR/UY/UG

LNP6DC-1



Long nose pliers for crimping IDC (insulation displacement) UR, UY, and UG type connectors.

- Crimps UR/UY/UG connectors
- Strips 22-24 AWG wire
- Induction hardened cutting blade
- Hot-rivet joint for smooth action and long life

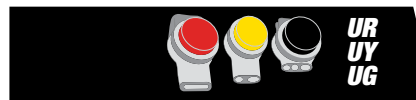

SPECIFICATIONS

| MODEL # | STOCK # | DESCRIPTION |
|----------|----------|--------------------------------------|
| LNP6DC-1 | 58744240 | Crimping Long Nose Pliers – UR/UY/UG |

VDV HAND TOOLS

MULTI-CONNECTOR COMPRESSION COAX CRIMP TOOL

CCM-C1



When you need versatility, multi-connector compression coax crimp tool is 3-way adjustable to work with F, BNC, and RCA compression connectors as well as RG59/6/6Q and RG7/11 coax cable.

- 3-way chuck can be positioned for cable TV "F", RCA, and BNC connectors
- Rotatable connector cradle accommodates RG59, RG6Q, RG6 as well as larger RG7 and RG11 cable
- Thumb-wheel for fine-tuning crimping length
- For cable TV, satellite, security, and home theater applications
- Comfortable double-molded grips are indexed to help orient the tool

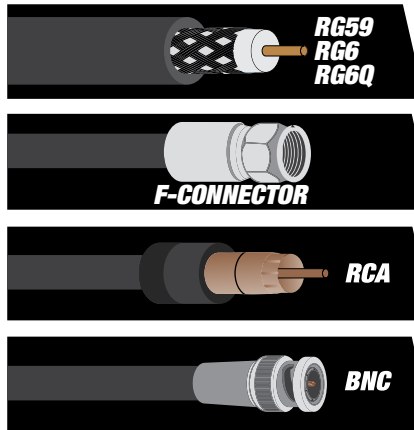

SPECIFICATIONS

| MODEL # | STOCK # | DESCRIPTION |
|---------|----------|---|
| CCM-C1 | 58743240 | Multi-Connector Compression Coax Crimp Tool |

VDV HAND TOOLS

COMPACT COMPRESSION COAX CRIMP TOOL FOR "F" CONNECTORS

CCF-C1



The CCF-C1 compact compression coax crimp tool securely attaches "F" type connectors to coax cable in one easy step. CCF-C1 features double-molded handles to provide a comfortable grip and powerful crimping force.

- Compatible with RG59, RG6, and RG6Q coaxial cable
- Simple, compact, and powerful
- Double-molded handles for durability and grip

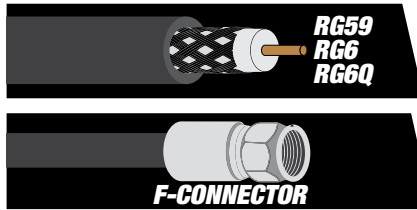

SPECIFICATIONS

| MODEL # | STOCK # | DESCRIPTION |
|---------|----------|--|
| CCF-C1 | 58743140 | Compact Compression Coax Crimp Tool - Cable TV "F" |



VDV HAND TOOLS

CABLE TV TOOL KIT

KIT-C1



This 13-piece cable TV tool kit includes all the tools you need to cut, strip, crimp, and install "F" connectors onto coax cable.

- Complete 13-piece kit for terminating coax
- Make custom length coax patch cables
- All 3 tools included to cut, strip, and crimp coax
- Kit includes:
 - Round Cable Cutter
 - Radial "Trigger" Stripper
 - Compression Crimper for "F" Connectors
 - 10 "F" Connectors for RG6 Coax
 - Rugged Tool Case

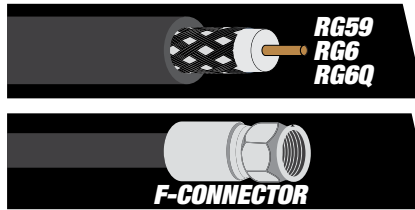

SPECIFICATIONS

| MODEL # | STOCK # | DESCRIPTION |
|---------|----------|-------------------|
| KIT-C1 | 58744040 | Cable TV Tool Kit |



VDV HAND TOOLS

COAX 3-IN-1 CRIMP TOOL

HCT-C1



The stainless steel Southwire 3-in-1 crimp tool cuts and strips coax as well as crimps Cable TV "F" hex-style connectors.

- One tool cuts, strips, and crimps coax cable
- Crimps "F" connectors
- Stainless steel for corrosion resistance
- Double-dipped textured grip

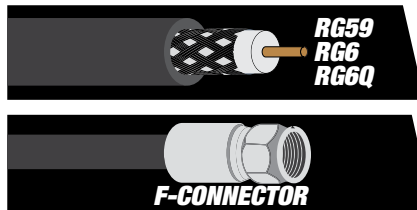

SPECIFICATIONS

| MODEL # | STOCK # | DESCRIPTION |
|---------|----------|------------------------|
| HCT-C1 | 58743940 | Coax 3-in-1 Crimp Tool |



FISHING & BENDING

Introducing our unique line of fish tapes, featuring a spiral extruded polymer design that reduces the amount of effort required to push or pull the fish tape through EMT and PVC conduit. Unlike fiberglass, the SIMpull™ fish tapes are kink resistant and virtually unbreakable, ensuring maximum efficiency*.

**As compared to Southwire steel and fiberglass fish tapes.*

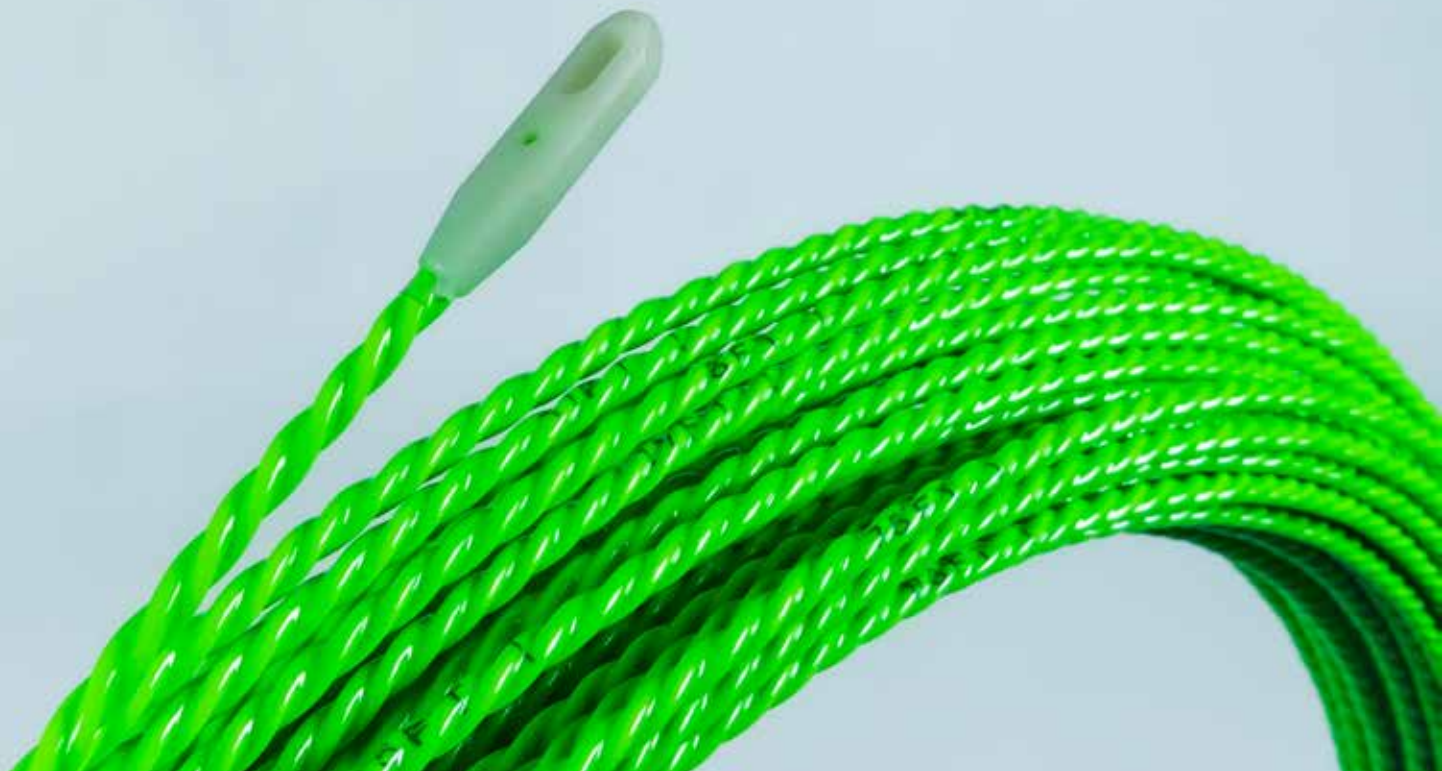

FISHING & BENDING

SIMpull™ NON-CONDUCTIVE TIP FISH TAPE



The SIMpull™ non-conductive fish tape is our best option to safely install new wire in conduit with existing wire. The spiral extruded polymer tape reduces the amount of effort required to push or pull the tape through EMT or PVC conduit.

- Tapered Tip – Reduces the chances of snagging on wire & conduit
- Improve Push – Bonded 4.5mm and 5.5mm diameter tape works well in conduit up to 3 inches
- Advanced Tape Guide & Housing – Improved internal mechanics to greatly increase efficiency of payout & reel-in
- Non-Conductive – Allows for safe installation over existing wires
- Durability Certified – Drop Rating of 15 feet
- Laser etched foot markings
- Versatile handle positioning

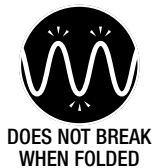

SPECIFICATIONS

| MODEL # | STOCK # | DESCRIPTION | | | |
|---------------|----------|--|-------|----------|---------|
| FTSP55-125NCT | 67015540 | SIMpull™ Non-Conductive Tip Fish Tape 5.5mm 125' | | | |
| FTSP45-125NCT | 63163740 | SIMpull™ Non-Conductive Tip Fish Tape 4.5mm 125' | | | |
| FTSP45-75NCT | 63029840 | SIMpull™ Non-Conductive Tip Fish Tape 4.5mm 75' | | | |
| | HEIGHT | WIDTH | DEPTH | DIAMETER | WEIGHT |
| FTSP55-125NCT | 16" | 12" | 2" | 5.5mm | 2.5 lbs |
| FTSP45-125NCT | 16" | 12" | 2" | 4.5mm | 2.5 lbs |
| FTSP45-75NCT | 16" | 12" | 1.5" | 4.5mm | 2.0 lbs |



FISHING & BENDING | SIMpull™ FISH TAPE

FISHING & BENDING

SIMpull™ FLEXIBLE METAL LEADER FISH TAPE



The SIMpull™ flexible metal leader tape excels at gliding through conduit with multiple bends. The spiral extruded polymer tape reduces the amount of effort required to push or pull the tape through EMT or PVC conduit.

- Swiveling Flexible Leader – Easily glides through conduit bends and around existing wire
- Improve Push – Bonded 4.5mm or 5.5 mm diameter tape works well in conduit up to 3 inches
- Advanced Tape Guide & Housing – Improved internal mechanics to greatly increase efficiency of payout & reel-in
- Durability Certified – Drop rated of 15 feet
- Laser etched foot markings
- Versatile handle positioning



NON-CONDUCTIVE LEADER



DOES NOT BREAK WHEN FOLDED



SWIVELING LEADER



FASTER INSTALL TIME

SPECIFICATIONS

| MODEL # | STOCK # | DESCRIPTION | | | |
|---------------|----------|---|-------|----------|---------|
| FTSP55-125FML | 67015240 | SIMpull™ Flexible Metal Leader Fish Tape 5.5mm 125' | | | |
| FTSP45-125FML | 59896940 | SIMpull™ Flexible Metal Leader Fish Tape 4.5mm 125' | | | |
| FTSP45-75FML | 59897040 | SIMpull™ Flexible Metal Leader Fish Tape 4.5mm 75' | | | |
| | HEIGHT | WIDTH | DEPTH | DIAMETER | WEIGHT |
| FTSP55-125FML | 16" | 12" | 2" | 5.5mm | 2.5 lbs |
| FTSP45-125FML | 16" | 12" | 2" | 4.5mm | 2.5 lbs |
| FTSP45-75FML | 16" | 12" | 1.5" | 4.5mm | 2.0 lbs |



FISHING & BENDING | SIMpull™ FISH TAPE

FISHING & BENDING

SIMpull™ FISH TAPE TUBE

FTSP45-240FMLT



The SIMpull™ tube is designed for long runs over 125'. This model has the added benefit of both leader types within the same unit. The spiral extruded polymer tape reduces the amount of effort required to push or pull the tape through EMT or PVC.

- Includes both a 360° swiveling flexible metal leader and a non-conductive glow in the dark leader, one on either end
- Swiveling Flexible Leader – Easily glides through conduit bends and around existing wire
- Improve Push – Bonded 5.5mm diameter tape works well in conduit up to 3 Inches
- Length Markings – Quickly identify the approximate length of a conduit run

SPECIFICATIONS

| MODEL # | STOCK # | DESCRIPTION | | | |
|----------------|----------|--|-------|----------|---------|
| FTSP55-240FMLT | 67015840 | SIMpull™ Tube Fish Tape with both FML & NCT Tips 5.5mm, 240' | | | |
| FTSP45-240FMLT | 63164740 | SIMpull™ Tube Fish Tape with both FML & NCT Tips 4.5mm, 240' | | | |
| | HEIGHT | WIDTH | DEPTH | DIAMETER | WEIGHT |
| FTSP55-240FMLT | 24" | 24" | 4" | 5.5mm | 4.3 lbs |
| FTSP45-240FMLT | 24" | 24" | 4" | 4.5mm | 4.3 lbs |

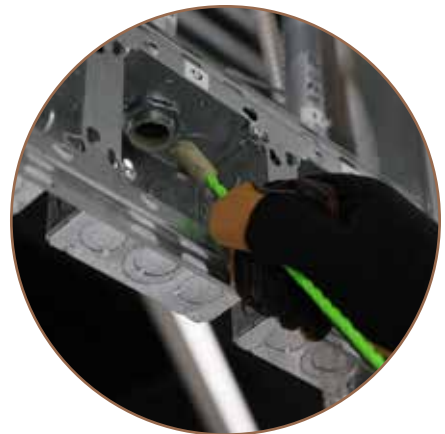
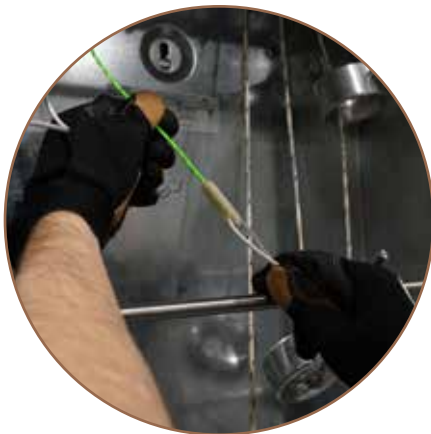

FISHING & BENDING | SIMpull™ FISH TAPE

FISHING & BENDING

STAINLESS STEEL FISH TAPE



Stainless steel tape incorporates the same benefits of steel but with added life.

- Stainless Steel – Highly resistant to rust & corrosion. Increasing the product's lifespan.
- Advanced Tape Guide & Housing – Improved internal mechanics to greatly increase efficiency of payout & reel-in.
- Durability Certified – Drop Rating of 15 Feet
- Laser etched foot markings
- Versatile handle positioning



SPECIFICATIONS

| MODEL # | STOCK # | DESCRIPTION | | | |
|--------------|----------|-------------------------------------|-------|---------|------------|
| FTS1/8-125SS | 67014640 | 125' Stainless Steel Fish Tape 1/8" | | | |
| FTS1/8-240SS | 67014940 | 240' Stainless Steel Fish Tape 1/8" | | | |
| | LENGTH | WIDTH | DEPTH | WEIGHT | TAPE WIDTH |
| FTS1/8-125SS | 17" | 12" | 2" | 4.5 lbs | 1/8" |
| FTS1/8-240SS | 17" | 12" | 2" | 7.3 lbs | 1/8" |

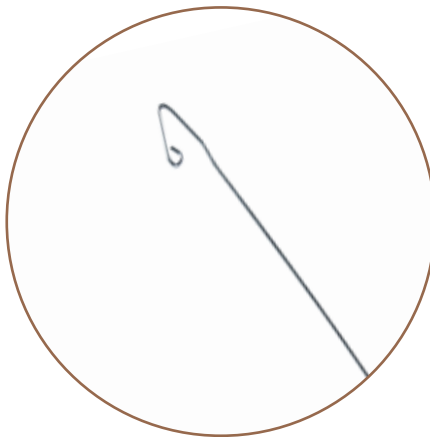

FISHING & BENDING

STEEL FISH TAPE



Southwire's steel fish tape reaches easily above ceilings, under carpets, and through walls to install wire. The fish tape is available in multiple lengths.

- Easy Pulls – Specially treated steel fish tape for longer life and easier pulling.
- Better Accuracy – Laser etched footage markings to help identify length of pull
- Rugged Design – High impact, durable case for long lasting performance and use.
- Laser etched foot markings
- Versatile handle positioning



SPECIFICATIONS

| MODEL # | STOCK # | DESCRIPTION | | | |
|------------|----------|---------------------------|-------|---------|------------|
| FTS1/8-240 | 58279840 | 1/8" Fish Tape Steel 240' | | | |
| FTS1/8-125 | 58279940 | 1/8" Fish Tape Steel 125' | | | |
| FTS1/8-25 | 58280240 | 1/8" Fish Tape Steel 25' | | | |
| | HEIGHT | WIDTH | DEPTH | WEIGHT | TAPE WIDTH |
| FTS1/8-240 | 17" | 12" | 2" | 7.3 lbs | 1/8" |
| FTS1/8-125 | 17" | 12" | 2" | 4.5 lbs | 1/8" |
| FTS1/8-25 | 8.5" | 7" | 1" | 1.0 lbs | 1/8" |

FISHING & BENDING

FISH TAPE LEADER



Flexible leader guides steel tapes through conduit and helps reduce the challenge of pulling and pushing.

- Flexible 13" leader easily attaches to 1/8" steel fish tapes
- Assists in guiding steel fish tapes through conduit turns and bends

SPECIFICATIONS

| MODEL # | STOCK # | DESCRIPTION | | | | |
|---------|----------|---|--------|------------|-----------------|---|
| FTFL13 | 58280640 | Fish Tape Leader 13' for Steel Fish Tapes | | | | |
| LENGTH | WIDTH | DEPTH | WEIGHT | TAPE WIDTH | EYELET CAPACITY | |
| FTFL13 | 14.25" | 0.38" | 0.25" | 2 oz. | 3/16 | 5 x 12 AWG Upstripped, 7 x 10 AWG Bare |

GLOW-IN-THE-DARK FISH STICK



Make fishing through walls or over ceilings easier with our Glow-in-the-Dark Fish Sticks.

- Luminescent fiberglass rods glow in the dark and recharge with most available light sources
- 3/16" flexible rods resist splintering and cracking
- Individual sections easily screw together to form single rod
- Includes bullet nose with eyelet and hook attachments

SPECIFICATIONS

| MODEL # | STOCK # | DESCRIPTION | | | |
|------------------|----------|---|--------|--------------|-------------|
| FS15 | 58279340 | 15' Glow-in-the-Dark Fish Stick (Includes Bullet Nose with Eyelet & Hook Attachments) | | | |
| FS12 | 58279440 | 12' Glow-in-the-Dark Fish Stick (Includes Bullet Nose with Eyelet & Hook Attachments) | | | |
| FS8 | 58279540 | 8' Glow-in-the-Dark Fish Stick (Includes Bullet Nose with Eyelet & Hook Attachments) | | | |
| ASSEMBLED LENGTH | WIDTH | DEPTH | WEIGHT | STICK LENGTH | |
| FS15 | 180" | 0.19" | 0.19" | 13.3 oz. | 3x5' Pieces |
| FS12 | 144" | 0.19" | 0.19" | 13.9 oz. | 3x4' Pieces |
| FS8 | 96" | 0.19" | 0.19" | 8 oz. | 4x2' Pieces |

FISHING & BENDING

CONDUIT BENDERS



Reliably and repeatedly perform common bends, such as stub-ups, offsets, back-to-back, and saddle bends. Available in 1", 3/4", and 1/2" sizes.

- Durable cast metal heads
- Swaged steel handle permits insertion of conduit to correct overbends
- Raised and highly visible bender markings are cast on both sides of the bender head
- Large serrated step provides greater control and helps prevent slipping when applying force

SPECIFICATIONS

| MODEL # | STOCK # | DESCRIPTION | | | |
|---------|----------|---|--------|--------------|------------------------|
| MCB1 | 58281440 | 1" EMT Conduit Bender with Handle (Ductile Iron Head) | | | |
| MCB3/4 | 58281240 | 3/4" EMT Conduit Bender with Handle (Aluminum Head) | | | |
| MCB1/2 | 58281340 | 1/2" EMT Conduit Bender with Handle (Aluminum Head) | | | |
| HEIGHT | WIDTH | DEPTH | WEIGHT | CONDUIT SIZE | |
| MCB1 | 1.75" | 12" | 45" | 13 lbs | 1" EMT 3/4" Rigid |
| MCB3/4 | 1.25" | 9" | 39" | 9 lbs | 3/4" EMT 1/2" Rigid |
| MCB1/2 | 1.25" | 8" | 39" | 7 lbs | 1/2" EMT |

FISHING & BENDING

12" HAND CABLE BENDER

CB12-350



The CB12-350 has a forged, one-piece, steel design for quick and easy bending. It is ideal for bending 350 MCM cables.

- Black oxide finish for corrosion resistance
- Dipped grip handles
- Forged one-piece design
- High strength steel
- 350 MCM cable capacity

SPECIFICATIONS

| MODEL # | STOCK # | DESCRIPTION | | |
|----------|----------|--|--------|----------|
| CB12-350 | 58739140 | CB12-350 12" 350 MCM Hand Cable Bender | | |
| LENGTH | WIDTH | DEPTH | WEIGHT | |
| CB12-350 | 12" | 1.86" | .85" | 0.95 lbs |

14" HAND CABLE BENDER

CB14-500



The CB14-500 has a forged, one-piece, steel design for quick and easy bending. It is ideal for bending 500 MCM cables.

- Black oxide finish for corrosion resistance
- Dipped grip handles
- Forged one-piece design
- High strength steel
- 500 MCM cable capacity

SPECIFICATIONS

| MODEL # | STOCK # | DESCRIPTION | | |
|----------|----------|--|--------|---------|
| CB14-500 | 58739240 | CB14-500 14" 500 MCM Hand Cable Bender | | |
| LENGTH | WIDTH | DEPTH | WEIGHT | |
| CB14-500 | 14.25" | 2.22" | 1.35" | 1.6 lbs |

TEST & MEASUREMENT

When there's no room for error, depend on our reliable test and measurement tools to get the job done. Backed by a five year warranty, these tools withstand the elements and provide accurate, versatile, and professional results that every electrician can count on.



MAPP™ MOBILE APP

MAPP™ MOBILE APP



TEST & MEASUREMENT | MAPP™



Download on the
App Store



GET IT ON
Google Play

Mobile app for connecting to Southwire Bluetooth® enabled meters.

- View readings from a safe distance right from your mobile phone
- Set up recording sessions
- Add photos and notes to create a detailed report
- Pop-up menu to modify meter settings remotely
- Communicate critical equipment issues by email

The Bluetooth word mark and logos are registered trademarks of Bluetooth® SIG, Inc. and any use of such marks by Southwire Company, LLC is under license. Apply & the Apple logo are trademarks of Apple, INC, registered in the U.S. and other countries. App Store is a service mark of Apple, Inc.

MAPP™ MOBILE APP

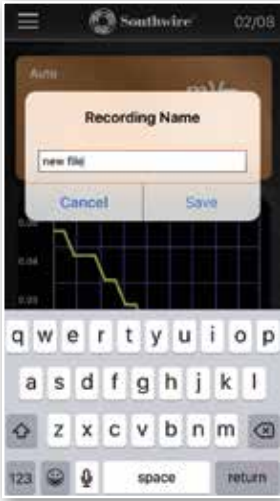

VIEW READINGS AND SET UP RECORDING SESSIONS FROM MOBILE DEVICE



JOB VALIDATION: ADD PHOTOS, NOTES AND GPS LOCATION



POP-UP MENU MODIFIES METER SETTINGS REMOTELY

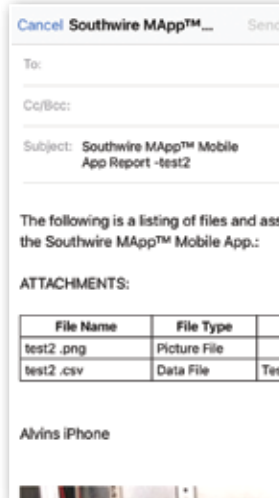

E-MAIL REPORTS TO MAINTENANCE TEAM ON CRITICAL EQUIPMENT ISSUES

TEST & MEASUREMENT

TECHNICIANPRO™ BLUETOOTH® CAT IV MULTIMETER

14090T



This Bluetooth® enabled multimeter in combination with Southwire's MApp™ mobile app allows you to view, record, and share readings on your smartphone. It is designed for demanding environments. Features include a CAT IV safety rating, a rugged IP67 waterproof and dust tight housing, TrueRMS and Low-Z readings, backlit controls, and a powerful built-in work light.

- Features automatic power off
- Bluetooth® interface for viewing, recording and sharing using Southwire's Mapp™ mobile app
- Lighted controls and backlit display allow use in dimly lit areas
- TrueRMS readings provide higher accuracy on AC circuits
- Low-Z function eliminates false readings from "ghost" voltage
- Includes magnetic hanging strap for hands-free operation
- Powerful LED work light for added convenience
- CAT IV 600V/CAT III 1000V safety rating and IP67 waterproof and dust tight housing
- Includes
 - Test leads
 - Type K temperature probe with banana plug adapter
 - Magnetic hanging strap
 - Carrying case
 - Four AAA batteries

DURABILITY CERTIFIED



TEST & MEASUREMENT | MULTIMETERS

| MODEL # | STOCK # | DESCRIPTION | |
|--------------------|----------------------------------|---|------------------------------|
| 14090T | 63018440 | TechnicianPRO™ Bluetooth® CAT IV Multimeter | |
| FUNCTION | RANGE | MAX. RESOLUTION | MAX. ACCURACY (% OF READING) |
| AC Voltage | 1000V | 1mV | ±1.0% |
| Low-Z (AC Voltage) | 600V | 1mV | ±3.0% |
| DC Voltage | 1000V | 0.1mV | ±0.9% |
| Low-Z (DC Voltage) | 600V | 0.1mV | ±3.0% |
| AC + DC Voltage | 1000V | 1mV | ±2.0% |
| AC Current | 10A | 0.1µA | ±1.0% |
| DC Current | 10A | 0.1µA | ±1.0% |
| Resistance | 60MΩ | 0.1Ω | ±1.5% |
| Capacitance | 6000µF | 10pF | ±3.0% |
| Frequency | 10kHz | 0.001Hz | ±1.0% |
| Duty Cycle | 20 to 80% | 0.1% | ±1.2% |
| Temperature | -4°F to 1400°F -20°C to 780°C | 0.1° | ±1.5% |
| Continuity | Audible threshold approx. 50Ω | | |
| Diode Test | Yes | | |
| Dimensions | 6.7 x 3.0 x 1.9 in. | | |
| Weight | 0.85 lb. | | |

TEST & MEASUREMENT

TECHNICIANPRO™ TRUERMS CAT IV MULTIMETER

14070T



This built-tough multimeter offers a CAT IV safety rating and an IP67 waterproof and dust tight housing. With TrueRMS readings, a Low-Z measurement function, backlit controls, and a powerful built-in work light, it has the features needed for the professional electrician.

- Features automatic power off
- Lighted controls and backlit display allow use in dimly lit areas
- Low-Z function eliminates false readings from "ghost" voltage
- TrueRMS readings provide higher accuracy on AC circuits
- Includes magnetic hanging strap for hands free operation
- Powerful LED work light for added convenience
- CAT IV 600V/CAT III 1000V safety rating and IP67 waterproof and dust tight housing
- Built-in test lead storage
- Includes
 - Test leads
 - Type K temperature probe with banana plug adapter
 - Magnetic hanging strap
 - Carrying case
 - Four AAA batteries



| MODEL # | STOCK # | DESCRIPTION | |
|--------------------|----------------------------------|--|------------------------------|
| 14070T | 63018240 | TechnicianPRO™ TrueRMS CAT IV Multimeter | |
| FUNCTION | RANGE | MAX. RESOLUTION | MAX. ACCURACY (% OF READING) |
| AC Voltage | 1000V | 1mV | ±1.0% |
| Low-Z (AC Voltage) | 600V | 1mV | ±3.0% |
| DC Voltage | 1000V | 0.1mV | ±1.0% |
| Low-Z (DC Voltage) | 600V | 0.1mV | ±3.0% |
| AC Current | 10A | 0.1µA | ±1.5% |
| DC Current | 10A | 0.1µA | ±1.0% |
| Resistance | 60MΩ | 0.1Ω | ±1.5% |
| Capacitance | 6000µF | 10pF | ±3.0% |
| Frequency | 10kHz | 0.001Hz | ±1.0% |
| Duty Cycle | 20 to 80% | 0.1% | ±1.2% |
| Temperature | -4°F to 1400°F -20°C to 780°C | 0.1° | ±2.0% |
| Continuity | Audible threshold approx. 50Ω | | |
| Diode Test | Yes | | |
| Dimensions | 6.7 x 3.0 x 1.9 in. | | |
| Weight | 0.85 lb. | | |

TEST & MEASUREMENT | MULTIMETERS

TEST & MEASUREMENT

TECHNICIANPRO™ AUTO RANGING CAT IV MULTIMETER

14060S



This built-tough multimeter offers a CAT IV safety rating and an IP67 waterproof and dust tight housing. With 11 measuring functions, backlit controls, and a powerful built-in work light, it's fully equipped for a wide range of applications.

- Features automatic power off
- 11 measuring functions plus MAX/MIN
- Lighted controls and backlit display allow use in dimly lit areas
- Powerful LED work light for added convenience
- Includes magnetic hanging strap for hands free operation
- Rugged IP67 waterproof and dust tight housing
- CAT IV 600V/CAT III 1000V safety rating, UL listed
- Built-in test lead storage
- Includes
 - Test leads
 - Type K temperature probe with banana plug adapter
 - Magnetic hanging strap
 - Carrying case
 - Four AAA batteries

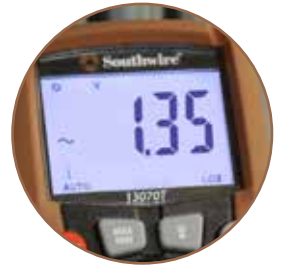

DURABILITY CERTIFIED



| MODEL # | STOCK # | DESCRIPTION | | |
|-------------|----------------------------------|---|------------------------------|--|
| 14060S | 63028740 | TechnicianPRO™ Auto-ranging CAT IV Multimeter | | |
| FUNCTION | RANGE | MAX. RESOLUTION | MAX. ACCURACY (% OF READING) | |
| AC Voltage | 1000V | 1mV | ±1.0% | |
| DC Voltage | 1000V | 0.1mV | ±1.0% | |
| AC Current | 10A | 0.1µA | ±1.5% | |
| DC Current | 10A | 0.1µA | ±1.0% | |
| Resistance | 60MΩ | 0.1Ω | ±1.5% | |
| Capacitance | 4000µF | 10pF | ±3.0% | |
| Frequency | 10kHz | 0.001Hz | ±1.0% | |
| Duty Cycle | 1 to 99.9% | 0.1% | ±1.2% | |
| Temperature | -4°F to 1400°F -20°C to 780°C | 0.1° | ±3.0% | |
| Continuity | Audible threshold approx. 30Ω | | | |
| Diode Test | Yes | | | |
| Dimensions | 6.7 x 3.0 x 1.9 in. | | | |
| Weight | 0.85 lb. | | | |

TEST & MEASUREMENT | MULTIMETERS

TEST & MEASUREMENT

RESIDENTIALPRO™ BLUETOOTH® CAT III MULTIMETER

13090T



This Bluetooth® enabled multimeter in combination with Southwire's MApp™ mobile app allows you to view, record, and share readings on your smartphone. With TrueRMS and Low-Z readings, a rugged waterproof and dust proof housing, and built-in flashlight, this compact multimeter can be used in a wide range of applications.

- Features automatic power off
- Bluetooth® interface for viewing, recording and sharing using Southwire's MApp™ mobile app
- TrueRMS readings provide higher accuracy on AC circuits
- Low-Z function eliminates false readings from "ghost" voltage
- Powerful LED work light for added convenience
- Rugged IP67 waterproof and dust tight housing
- CAT III 600V safety rating, UL listed
- Built-in test lead storage
- Includes
 - Test leads
 - Type K temperature probe with banana plug adapter
 - Three AAA batteries



| MODEL # | STOCK # | DESCRIPTION | |
|--------------------|---------------------------------|---|------------------------------|
| 13090T | 63016040 | ResidentialPRO™ Bluetooth® CAT III Multimeter | |
| FUNCTION | RANGE | MAX. RESOLUTION | MAX. ACCURACY (% OF READING) |
| AC Voltage | 600V | 1mV | ±1.0% |
| Low-Z (AC Voltage) | 300V | 1mV | ±1.5% |
| DC Voltage | 600V | 0.1mV | ±1.0% |
| Low-Z (DC Voltage) | 300V | 0.1mV | ±1.5% |
| AC Current | 10A | 1mA | ±2.5% |
| DC Current | 10A | 1mA | ±2.0% |
| Resistance | 40MΩ | 0.1Ω | ±1.5% |
| Capacitance | 4000μF | 10pF | ±3.0% |
| Frequency | 10kHz | 0.001Hz | ±1.0% |
| Duty Cycle | 1.0 to 99.9% | 0.1% | ±1.2% |
| Temperature | 0°F to 1400°F -18°C to 760°C | 0.1° | ±2.0% |
| Continuity | Audible threshold: approx. 50Ω | | |
| Diode Test | Yes | | |
| Dimensions | 5.8 x 2.7 x 2.0 in. | | |
| Weight | 0.70 lb. | | |

TEST & MEASUREMENT | MULTIMETERS

TEST & MEASUREMENT

RESIDENTIALPRO™ TRUERMS CAT III MULTIMETER

13070T



LOW-Z



TRUE RMS



With 11 measurement functions including TrueRMS readings, Low-measurement features, and a rugged waterproof and dust proof housing, this compact multimeter has the features needed to get the job done. A built-in flashlight provides added convenience.

- Features automatic power off
- TrueRMS readings provide higher accuracy on AC circuits
- Low-Z function eliminates false readings from "ghost" voltage
- 11 measuring functions plus MAX/MIN
- Powerful LED work light for added convenience
- Rugged IP67 waterproof and dust tight housing
- CAT III 600V safety rating, UL listed
- Built-in test lead storage
- Includes
 - Test leads
 - Type K temperature probe with banana plug adapter
 - Three AAA batteries



DURABILITY CERTIFIED



| MODEL # | STOCK # | DESCRIPTION | |
|--------------------|----------------------------------|--|------------------------------|
| 13070T | 63015040 | ResidentialPRO™ TrueRMS CAT III Multimeter | |
| FUNCTION | RANGE | MAX. RESOLUTION | MAX. ACCURACY (% OF READING) |
| AC Voltage | 600V | 1mV | ±1.5% |
| Low-Z (AC Voltage) | 300V | 1mV | ±1.5% |
| DC Voltage | 600V | 0.1mV | ±0.8% |
| Low-Z (DC Voltage) | 300V | 0.1mV | ±0.8% |
| AC Current | 10A | 1mA | ±3.0% |
| DC Current | 10A | 1mA | ±2.5% |
| Resistance | 40MΩ | 0.1Ω | ±1.2% |
| Capacitance | 4000μF | 10pF | ±3.0% |
| Frequency | 10kHz | 0.001Hz | ±1.2% |
| Duty Cycle | 0.1 to 99.9% | 0.1% | ±1.2% |
| Temperature | -4°F to 1400°F -20°C to 760°C | 0.1° | ±3.0% |
| Continuity | Audible threshold approx. 40Ω | | |
| Diode Test | Yes | | |
| Dimensions | 5.8 x 2.7 x 2.0 in. | | |
| Weight | 0.70 lb. | | |

TEST & MEASUREMENT | MULTIMETERS

TEST & MEASUREMENT

RESIDENTIALPRO™ AUTO RANGING CAT III MULTIMETER

13050S



With 11 measuring functions, an easy-to-read backlit display, and a rugged IP67 waterproof and dust proof housing, this compact multimeter is perfect for general use. A built-in flashlight provides added convenience.

- Features automatic power off
- 11 Measuring functions plus MAX/MIN
- Backlit 4,000-count display with bar graph
- Powerful LED work light for added convenience
- Rugged IP67 waterproof and dust tight housing
- CAT III 600V safety rating UL listed
- Built-in test lead storage
- Includes
 - Test leads
 - Type K temperature probe with banana plug adapter
 - Three AAA batteries



DURABILITY CERTIFIED



| MODEL # | STOCK # | DESCRIPTION | |
|-------------|----------------------------------|---|------------------------------|
| 13050S | 63014540 | ResidentialPRO™ Auto ranging CAT III Multimeter | |
| FUNCTION | RANGE | MAX. RESOLUTION | MAX. ACCURACY (% OF READING) |
| AC Voltage | 600V | 1mV | ±1.5% |
| DC Voltage | 600V | 0.1mV | ±0.8% |
| AC Current | 10A | 1mA | ±3.0% |
| DC Current | 10A | 1mA | ±3.0% |
| Resistance | 40MΩ | 0.1Ω | ±1.2% |
| Capacitance | 4000μF | 10pF | ±3.0% |
| Frequency | 10kHz | 0.001Hz | ±1.2% |
| Duty Cycle | 0.1 to 99.9% | 0.1% | ±1.2% |
| Temperature | -4°F to 1400°F -20°C to 760°C | 0.1° | ±3.0% |
| Continuity | Audible threshold approx. 50Ω | | |
| Diode Test | Yes | | |
| Dimensions | 5.8 x 2.7 x 2.0 in. | | |
| Weight | 0.70 lb. | | |

TEST & MEASUREMENT | MULTIMETERS

TEST & MEASUREMENT

AUTOSELECTING CAT IV MULTIMETER

16030A



Easy-to-use TrueRMS CAT IV multimeter automatically selects AC or DC voltage when connected to live circuits. Added features include a rugged IP67 waterproof and dust tight housing, a built-in flashlight and non-contact AC voltage detector, and auto hold for fast touch-and-hold readings.

- Features automatic power off
- Automatically selects AC or DC voltage
- Auto hold function for quick touch and hold readings
- TrueRMS readings provide higher accuracy on AC circuits
- Easy-to-read 4,000-count backlit display
- Built-in, non-contact AC voltage detector and powerful work light
- Rugged IP67 waterproof/dust tight housing
- CAT IV 600V safety rating, UL listed
- Built-in test lead storage
- Includes
 - Test leads
 - Two AAA batteries



TEST & MEASUREMENT | MULTIMETERS

| MODEL # | STOCK # | DESCRIPTION | |
|------------------------|-------------------------------|---------------------------------|------------------------------|
| 16030A | 63019140 | Autoselecting CAT IV Multimeter | |
| FUNCTION | RANGE | MAX. RESOLUTION | MAX. ACCURACY (% OF READING) |
| AC Voltage | 600V | 0.1V | ±1.0% |
| DC Voltage | 600V | 0.1V | ±1.0% |
| Non-Contact AC Voltage | 100 to 600V AC | — | — |
| Resistance | 400kΩ | 0.1Ω | ±2.0% |
| Continuity | Audible threshold approx. 50Ω | | |
| Dimensions | 5.5 x 3.0 x 1.6 in. | | |
| Weight | 0.50 lb. | | |

TEST & MEASUREMENT

COMPACT 3-IN-1 CAT IV MULTIMETER

16020N



Designed for the electrician on the go, this compact CAT IV 3-in-1 combination multimeter with built-in flashlight and non-contact AC voltage detector is a great fit for a crowded tool bag.

- Features automatic power off
- 3-in-1 Combination: multimeter, work light and non-contact AC voltage detector
- Compact size with integrated test leads is perfect for crowded tool bag
- 10 measuring functions
- Fuse automatically resets itself
- Rugged double-molded housing
- CAT IV 600V safety rating, UL listed
- Built-in test lead storage
- Includes:
 - Multimeter with integrated test leads
 - Two AAA batteries



| MODEL # | STOCK # | DESCRIPTION | |
|------------------------|--------------------------------|----------------------------------|------------------------------|
| 16020N | 63018640 | Compact 3-in-1 CAT IV Multimeter | |
| FUNCTION | RANGE | MAX. RESOLUTION | MAX. ACCURACY (% OF READING) |
| AC Voltage | 600V | 0.1mA | ± 1.0% |
| DC Voltage | 600V | 0.1mA | ± 0.5% |
| Non-Contact AC Voltage | 100 to 600V AC | — | — |
| AC Current | 200mA | 0.1µA | ±2.5% |
| DC Current | 200mA | 0.1µA | ±2.0% |
| Resistance | 40MΩ | 0.1Ω | ±0.8% |
| Capacitance | 100µF | 10pF | ±3.0% |
| Frequency | 10kHz | 0.001Hz | ±2.0% |
| Duty Cycle | 0.5 to 99% | 0.1% | ±2.0% |
| Continuity | Audible threshold approx. 100Ω | | |
| Diode Test | Yes | | |
| Dimensions | 4.6 x 2.3 x 1.4 in. | | |
| Weight | 0.32 lb. | | |

TEST & MEASUREMENT | MULTIMETERS

TEST & MEASUREMENT

AUTO-RANGING MULTIMETER

10041N



The Southwire 10041N multimeter provides all the features & functions you'll ever need in an affordable multimeter. Features include a rugged double-molded housing, CAT III 600V safety rating, and a built-in non-contact AC voltage tester. Meets the latest UL safety standards.

- Measures AC/DC voltage up to 600V, Resistance up to 2MΩ, and AC and DC current up to 10A
- CAT III 600V Safety Rating
- Measures capacitance, frequency, temperature and duty cycle. Tests batteries, continuity, and diodes.
- Built-In Non-Contact AC Voltage Detector
- Convenience features include built-in test probe holder, kickstand, easy-change fuses, and accepts Southwire magnetic hanging strap (available separately)
- Built to withstand a 6-foot drop
- Meets the latest UL safety standard
- Backlit LCD Display
- Auto Power Off preserves battery life



DURABILITY CERTIFIED



| MODEL # | STOCK # | DESCRIPTION | |
|---------------|---------------------|-------------------------|------------------------------|
| 10041N | 65031240 | Auto-Ranging Multimeter | |
| | RANGE | MAX. RESOLUTION | MAX. ACCURACY (% OF READING) |
| AC Voltage | 600V | 1mV | +/- (1.2%+5) |
| DC Voltage | 600V | 0.1mV | +/- (0.8%+8) |
| NCV | 50-600V | | |
| AC Current | 10A | 0.1μA | +/- (1.5%+5) |
| DC Current | 10A | 0.1μA | +/- (1.0%+5) |
| Resistance | 40.00MΩ | 0.1Ω | +/- (1.2%+5) |
| Capacitance | 100μF | 10pF | +/- (5.0%+/- 7) |
| Frequency | 10MHz | 0.01Hz | +/- (1.0%+5) |
| Duty Cycle | 99.90% | 0.10% | +/- 1.5% +/- 5 |
| Temperature | -22 to 140°F | 1°F | +/- 3% |
| Diode Test | | .001V | |
| Continuity | | 0.1Ω | |
| Diode Test | | .001V | |
| Battery Test | 1.5V | 1mV | +/- (1.0%+5) |
| Battery Test | 9V | 10mV | +/- (1.0%+5) |
| Dimensions | 6.1 x 2.9 x 2.1 in. | | |
| Weight | 0.5lb. | | |
| Safety Rating | CAT III 600V | | |

TEST & MEASUREMENT | MULTIMETERS

TEST & MEASUREMENT

MANUAL RANGING MULTIMETER

10031S



This Southwire general purpose multimeter is perfect for basic electrical repairs & troubleshooting. Features include a rugged double-molded housing, large LCD display, and battery test function. Meets the latest UL safety standards.

- Measures AC/DC voltage up to 600V, Resistance up to 2MΩ, and DC current up to 10A
- CAT III 300V Safety Rating
- Tests batteries and continuity
- Built to withstand a 6-foot drop
- Meets the latest UL safety standard
- Convenience features include built-in test probe holder, kickstand, easy-change fuses, and accepts Southwire magnetic hanging strap (available separately)
- Auto Power Off preserves battery life



DURABILITY CERTIFIED



| MODEL # | STOCK # | DESCRIPTION | |
|---------------|---------------------|------------------------------|---------------|
| 10031S | 65031140 | Manual-Ranging Multimeter | |
| RANGE | MAX. RESOLUTION | MAX. ACCURACY (% OF READING) | |
| AC Voltage | 600V | 100mV | +/- (1.2%+10) |
| DC Voltage | 600V | 0.1mV | +/- (0.8%+8) |
| DC Current | 10A | 1μA | +/- (1.0%+5) |
| Resistance | 2.000MΩ | 0.1Ω | +/- (0.8%+5) |
| Continuity | | 0.1Ω | |
| Battery Test | 1.5V | 1mV | +/- (1.0%+5) |
| Battery Test | 9V | 10mV | +/- (1.0%+5) |
| Dimensions | 6.1 x 2.9 x 2.1 in. | | |
| Weight | 0.6lb. | | |
| Safety Rating | CAT III 300V | | |

TEST & MEASUREMENT | MULTIMETERS

TEST & MEASUREMENT

MAINTENANCEPRO™ SMART 1000A CLAMP METER

23090T



Southwire's new MaintenancePRO™ 23090T adds Bluetooth® connectivity to a rugged, high-end clamp meter. Used with our MApp™ mobile app, the 23090T lets electricians safely get the measurements they need even in hostile environments. The app can be used to view readings, set up recording sessions, and assemble complete reports right from your mobile phone. The feature set of the 23090T make this the optimal choice for the professional electrician.

- Features automatic power off
- Bluetooth® interface for viewing, saving and sharing using Southwire's MApp™ mobile app
- Inrush function captures motor start-up current
- 11 measuring functions, plus MAX/MIN
- Precision TrueRMS meter
- Hi-Res 50,000-count backlit display with bargraph
- Built-in, non-contact AC voltage detector and powerful LED work light
- Rugged meter with CAT IV 600V / CAT III 1000V safety rating, UL listed
- Includes:
 - Test leads
 - Type K temperature probe with banana plug adapter
 - Carrying case
 - 9 volt battery



TEST & MEASUREMENT | CLAMP METERS

| MODEL # | STOCK # | DESCRIPTION | | |
|------------------------|--------------------------------------|--|------------------------------|--|
| 23090T | 59686840 | MaintenancePRO™ Bluetooth® 1000A Clamp Meter | | |
| FUNCTION | RANGE | MAX. RESOLUTION | MAX. ACCURACY (% OF READING) | |
| AC Current | 1000A | 10mA | ±2.5% | |
| DC Current | 1000A | 10mA | ±2.5% | |
| Jaw Opening | 1.9" (48mm) | — | — | |
| AC Voltage | 1000V | 0.01mV | ±1.0% | |
| DC Voltage | 1000V | 0.01mV | ±1.0% | |
| Non-Contact AC Voltage | 110 to 1000V AC | — | — | |
| Resistance | 50MΩ | 0.01Ω | ±1.0% | |
| Capacitance | 5mF | 10pF | ±3.5% | |
| Frequency | 10MHz | 0.001Hz | ±0.3% | |
| Duty Cycle | 5 to 95% | 0.01% | ±1.0% | |
| Temperature | -148°F to 1832°F -100°C to 1000°C | 0.1° | ±1.0% | |
| Continuity | Audible threshold approx. 50Ω | | | |
| Diode Test | Yes | | | |
| Dimensions | 9.0 x 3.0 x 1.6 in. | | | |
| Weight | 0.69 lb. | | | |

TEST & MEASUREMENT

MAINTENANCEPRO™ 1000A AC/DC CLAMP METER

23070T



The MaintenancePRO™ 23070T clamp meter is a rugged, high-end AC/DC clamp meter for the professional electrician who needs both AC and DC current measurements. With a UL listed safety rating of CAT IV 600V/CAT III 1000V, this clamp meter is built to get the tough jobs done.

- Features automatic power off
- 11 measuring functions plus MAX/MIN
- TrueRMS readings provide higher accuracy on AC circuits
- Measures both AC and DC current
- Built-in, non-contact AC voltage detector and powerful LED work light
- 6,000-count backlit display with bar graph
- Rugged meter with CAT IV 600V/CAT III 1000V safety rating, UL listed
- Includes:
 - Test leads
 - Type K temperature probe with banana plug adapter
 - Carrying case
 - 9 volt battery



| MODEL # | STOCK # | DESCRIPTION | |
|------------------------|----------------------------------|---|------------------------------|
| 23070T | 59686740 | MaintenancePRO™ 1000A AC/DC Clamp Meter | |
| FUNCTION | RANGE | MAX. RESOLUTION | MAX. ACCURACY (% OF READING) |
| AC Current | 1000A | 10mA | ±2.5% |
| DC Current | 1000A | 10mA | ±2.5% |
| Jaw Opening | 1.9" (48mm) | — | — |
| AC Voltage | 1000V | 1mV | ±1.5% |
| DC Voltage | 1000V | 0.1mV | ±1.0% |
| Non-Contact AC Voltage | 100 to 1000V AC | — | — |
| Resistance | 60MΩ | 0.1Ω | ±1.0% |
| Capacitance | 6000μF | 10pF | ±3.0% |
| Frequency | 10MHz | 0.001Hz | ±1.0% |
| Duty Cycle | 0.5 to 99.9% | 0.01% | ±1.2% |
| Temperature | -4°F to 1400°F -20°C to 760°C | 0.1° | ±3.0% |
| Continuity | Audible threshold approx. 50Ω | | |
| Diode Test | Yes | | |
| Dimensions | 9.0 x 3.0 x 1.6 in. | | |
| Weight | 0.69 lb. | | |

TEST & MEASUREMENT | CLAMP METERS

TEST & MEASUREMENT

MAINTENANCEPRO™ 1000A AC CLAMP METER

23030T



The MaintenancePRO™ 23030T clamp meter is a rugged, high-end AC clamp meter. With a UL listed safety rating of CAT IV 600V/CAT III 1000V, this clamp meter is built to get the tough jobs done. The feature set of the 23030T make it the new standard in residential, commercial, and maintenance clamp meters.

- Features automatic power off
- 10 measuring functions plus MAX/MIN
- TrueRMS readings provide higher accuracy on AC circuits
- Powerful LED work light for added convenience
- Built-in, non-contact AC voltage detector
- 6,000-count backlit display with bar graph
- Rugged meter with CAT IV 600V/CAT III 1000V safety rating, UL listed
- Includes:
 - Test leads
 - Type K temperature probe with banana plug adapter
 - Carrying case
 - 9 volt battery



TEST & MEASUREMENT | CLAMP METERS

| MODEL # | STOCK # | DESCRIPTION | | |
|------------------------|----------------------------------|--------------------------------------|------------------------------|--|
| 23030T | 59686640 | MaintenancePRO™ 1000A AC Clamp Meter | | |
| FUNCTION | RANGE | MAX. RESOLUTION | MAX. ACCURACY (% OF READING) | |
| AC Current | 1000A | 10mA | ±2.5% | |
| Jaw Opening | 1.9" (48mm) | — | — | |
| AC Voltage | 1000V | 1mV | ±1.5% | |
| DC Voltage | 1000V | 0.1mV | ±1.0% | |
| Non-Contact AC Voltage | 100 to 1000V AC | — | — | |
| Resistance | 60MΩ | 0.1Ω | ±1.0% | |
| Capacitance | 6000μF | 10pF | ±3.0% | |
| Frequency | 10MHz | 0.001Hz | ±1.0% | |
| Duty Cycle | 0.5 to 99.9% | 0.01% | ±1.2% | |
| Temperature | -4°F to 1400°F -20°C to 760°C | 0.1° | ±3.0% | |
| Continuity | Audible threshold approx. 50Ω | | | |
| Diode Test | Yes | | | |
| Dimensions | 9.0 x 3.0 x 1.6 in. | | | |
| Weight | 0.69 lb. | | | |

TEST & MEASUREMENT

400A AC/DC TRUE RMS CLAMP METER

21550T



The Southwire 21550T 400A AC/DC clamp meter with True RMS offers the features needed for the professional electrician including True RMS accuracy, the ability to measure both AC and DC current, and a built-in, non-contact, AC voltage detector. Other features included are REL and max/min functions in addition to standard multimeter functions such as resistance, capacitance, continuity, temperature, and diode. This clamp meter also has a third-hand test probe holder and a bright LED worklight. The 21550T is built-to-last and is guaranteed to survive a 6-foot drop.

- 400A AC/DC Current Range
- CAT III 600V Safety Rating
- True RMS Accuracy
- Built-In Non-Contact Voltage Tester
- Third-Hand Test Probe Holder



| MODEL # | STOCK # | DESCRIPTION | |
|---------------|------------------|---------------------------------|------------------------------|
| 21550T | 65031840 | 400A AC/DC True RMS Clamp Meter | |
| FUNCTION | RANGE | MAX. RESOLUTION | MAX. ACCURACY (% OF READING) |
| AC Current | 400A | 0.01A | +/- (2.0%+9) |
| DC Current | 400A | 0.01A | +/- (2.0%+5) |
| AC Voltage | 600V | 0.001V | +/- (1.0%+5) |
| DC Voltage | 600V | 0.1mV | +/- (1.0%+8) |
| NCV | Yes | | |
| Resistance | 40MΩ | 0.1Ω | +/- (1.0%+4) |
| Capacitance | 1000μF | 0.1nF | +/- (5.0%+/- 7) |
| Temperature | -5 - 750°F | 1°F | +/- 3.0% |
| Continuity | | 0.1Ω | |
| Diode Test | | .001V | |
| Jaw Opening | 1.1 in. (28mm) | | |
| Dimensions | 9" x 2.7" x 1.4" | | |
| Weight | 0.6lb. | | |
| Safety Rating | CAT III 600V | | |

TEST & MEASUREMENT | CLAMP METERS

TEST & MEASUREMENT

400A AC TRUE RMS CLAMP METER

21530T



The Southwire 21530T 400A AC clamp meter with True RMS offers the features needed for the professional electrician. It provides True RMS accuracy, AC current up to 400A, and a built-in, non-contact, AC voltage detector. Common multimeter functions include AC/DC voltage up to 600V, resistance, capacitance, continuity, temperature, and diode. The 21530T also provides a third-hand test probe holder and LED worklight for added convenience. The 21530T is built-to-last and is guaranteed to survive a 6-foot drop. Great for the professional.

- 400A AC Current Range
- CAT III 600V Safety Rating
- True RMS Accuracy
- Built-In Non-Contact Voltage Tester
- Third-Hand Test Probe Holder



TEST & MEASUREMENT | CLAMP METERS

| MODEL # | STOCK # | DESCRIPTION | |
|------------------------------|------------------|------------------------------|-------------------------------|
| 21530T | 65031640 | 400A AC True RMS Clamp Meter | |
| FUNCTION | RANGE | MAX. RESOLUTION | MAX. ACCURACY (% OF READING) |
| Feature | Range | Max. Resolution | Max. Accuracy (% of Reading) |
| AC Current | 400A | 0.01A | +/- (2.0%+9) |
| AC Voltage | 600V | 0.001V | +/- (1.0%+5) |
| DC Voltage | 600V | 0.1mV | +/- (1.0%+8) |
| NCV (non-contact AC Voltage) | Yes | | |
| Resistance | 40MΩ | 0.1Ω | +/- (1.0%+4) |
| Capacitance | 1000μF | 0.1nF | +/- (3.0%+5) |
| Temperature | -5°F - 750°F | 1°F | +/- 3.0% |
| Continuity | | 0.1Ω | |
| Diode Test | | 0.001V | |
| Jaw Opening | 1.1 in. (28mm) | | |
| Dimensions | 9" x 2.7" x 1.4" | | |
| Weight | 0.6 lb. | | |
| Safety Rating | CAT III 600V | | |

TEST & MEASUREMENT

400A AC CLAMP METER

21510N



The Southwire 21510N 400A AC clamp meter offers the features needed for routine electrical repairs. In addition to measuring AC current up to 400A, the 21510N measures AC and DC voltage up to 600V plus provides common multimeter functions such as resistance, capacitance, continuity, temperature and diode. The 21510N offers a built-in, non-contact AC voltage detector and a powerful LED worklight for working in dimly lit areas. The 21510N also features a third-hand test probe holder for added convenience. This CAT III clamp meter is designed to survive a 6-foot drop, making it built to last. Great for basic electrical work.

- 400A AC current range
- CAT III 600V safety rating
- Built-in non-contact voltage tester
- Third-hand test probe holder



| MODEL # | STOCK # | DESCRIPTION | |
|------------------------------|------------------|---------------------|-------------------------------|
| 21510N | 65031540 | 400A AC Clamp Meter | |
| FUNCTION | RANGE | MAX. RESOLUTION | MAX. ACCURACY (% OF READING) |
| Feature | Range | Max. Resolution | Max. Accuracy (% of Reading) |
| AC Current | 400A | 0.01A | +/- (2.0%+9) |
| AC Voltage | 600V | 0.001V | +/- (1.0%+5) |
| DC Voltage | 600V | 0.1mV | +/- (1.0%+8) |
| NCV (non-contact AC Voltage) | Yes | | |
| Resistance | 40MΩ | 0.1Ω | +/- (1.0%+4) |
| Capacitance | 1000μF | 0.1nF | +/- (3.0%+5) |
| Temperature | -5°F - 750°F | 1°F | +/- 3.0% |
| Continuity | | 0.1Ω | |
| Diode Test | | 0.001V | |
| Jaw Opening | 1.1 in. (28mm) | | |
| Dimensions | 9" x 2.7" x 1.4" | | |
| Weight | 0.6 lb. | | |
| Safety Rating | CAT III 600V | | |

TEST & MEASUREMENT | CLAMP METERS

TEST & MEASUREMENT

LCD VOLTAGE TESTER 600V AC/DC

41171N



Get a multimeter and non-contact voltage detector in one pocket tester. Great for beginning or experienced electricians. Features one of the largest backlit LCD displays in this category. Performs three essential electrician tasks: voltage detection, voltage testing, and continuity. Tests AC and DC voltage up to 600V. Features a built-in non-contact voltage detector and tests continuity with both visual and audible indicators. Fits comfortably in the pocket and has replaceable test leads. 5-year, no hassle warranty.

- Backlit LCD Display
- Built-in Non Contact Voltage Detector with Self Test
- Tests Continuity with visual & audible confirmation
- Bright LED Flashlight
- 0-600V AC measurement range
- 0-600V DC measurement range
- Replaceable Test Leads
- CAT IV 600V Safety Rated
- 6.5' drop tested



DURABILITY CERTIFIED



| MODEL # | STOCK # | DESCRIPTION |
|-----------------------|--|-------------------------------|
| 41171N | 65112140 | LCD Voltage Tester 600V AC/DC |
| Voltage | 6-600V AC/DC | |
| Safety Rating | CAT IV 600 V, Class 2, Double Insulation | |
| NCV Detection Range | 100 V AC to 1000 V AC | |
| Drop Protection | 6.5 feet (2 meters) | |
| AC Frequency Range | 50 Hz/60 Hz | |
| Operating Temperature | 32 °F to 104 °F (0°C to 40°C) | |
| Storage Temperature | 14 °F to 122 °F (-10°C to 50°C) | |

TEST & MEASUREMENT

VOLTAGE TESTER 600V AC 400V DC

41161N



An ideal test tool for the beginning electrician or for use as a back-up tester for more experienced electricians. Perfect for trade schools too. Performs three essential functions: voltage detection, voltage testing, and continuity. Features an easy-to-read LED display and tests AC voltage up to 600V and DC voltage up to 400V. Has a built-in non-contact voltage detector and tests continuity. Fits comfortably in the pocket, accepts a hanging strap, and has replaceable test leads. 5-year, no hassle warranty.

- Bright LED Display
- Built-in Non Contact Voltage Detector with Self Test
- Tests Continuity with visual & audible confirmation
- Bright LED Flashlight
- Indicates AC voltage from 12-600V AC in 9 steps
- Indicates DC voltage from 9-400V in 9 steps with polarity indication
- Replaceable Test Leads
- CAT IV 600V Safety Rated
- 6.5' drop tested



| MODEL # | STOCK # | DESCRIPTION |
|-----------------------|--|--------------------------------|
| 41161N | 65112040 | Voltage Tester 600V AC 400V DC |
| Voltage LED Steps | AC: 12, 24, 48, 120, 208, 240, 277, 480, 600 DC: 9, 12, 24, 36, 48, 60, 110, 220, 400 | |
| Safety Rating | CAT IV 600 V, Class 2, Double Insulation | |
| NCV Detection Range | 100 V AC to 1000 V AC | |
| Drop Protection | 6.5 feet (2 meters) | |
| AC Frequency Range | 50 Hz/60 Hz | |
| Operating Temperature | 32 °F to 104 °F (0°C to 40°C) | |
| Storage Temperature | 14 °F to 122 °F (-10°C to 50°C) | |

TEST & MEASUREMENT | VOLTAGE TESTERS

TEST & MEASUREMENT

VOLTAGE TESTER 480V AC 110V DC

41151S



The 41151S compact voltage and GFCI tester features an easy to read LED display. It's a simple and safe way to test for live circuits, measure voltage, and test if GFCI circuits are functioning properly. This pocket tester tests AC voltage up to 480V and DC voltage up to 110V.

- Bright LED Display
- Indicates AC voltage from 12-480V in 6 steps
- Indicated DC voltage from 9-110V in 6 steps with polarity indication
- Tests GFCI outlets and circuits
- CAT III 600V safety rating
- Tamper resistant outlet compatible
- Test probes store concealed
- 6.5' drop tested



DURABILITY CERTIFIED



6.5' DROP TESTED

| MODEL # | STOCK # | DESCRIPTION |
|-----------------------|---|--------------------------------|
| 41151S | 65111940 | Voltage Tester 480V AC 110V DC |
| Voltage LED Steps | AC: 12, 24, 48, 120, 240, 480 DC: 9, 12, 24, 36, 48, 110 | |
| Safety Rating | CAT III 600V | |
| Drop Protection | 6.5 feet (2 meters) | |
| AC Frequency Range | 50 Hz - 60 Hz | |
| Operating Temperature | 32 °F to 104 °F (0°C to 40°C) | |
| Storage Temperature | 14 °F to 122 °F (-10°C to 50°C) | |

TEST & MEASUREMENT | VOLTAGE TESTERS

TEST & MEASUREMENT

ADVANCED DUAL RANGE NCV 12-1000V AC

40150N



Advanced dual range NCV 12-1000V & 100-1000V AC.

- Features automatic power off
- High power rear flashlight and forward facing flashlight
- Thinner probe tip for working with wall outlets
- Power switch (standard)
- Green LED means Power on
- Flashing red LED with beeper means voltage is detected
- Low-Battery self test
- High voltage and low voltage modes
- Silent mode
- IP67 Waterproof



DURABILITY CERTIFIED



| MODEL # | STOCK # | DESCRIPTION |
|-----------------------|--|--|
| 40150N | 63020740 | 40150N Advanced Dual Range NCV 12-1000V AC |
| AC Detection Range | 12-1000V & 100-1000V AC | |
| Safety Rating | CAT IV 1000V | |
| Frequency Range | 50/60Hz | |
| Batteries | Two AAA | |
| Operating Temperature | 32°F to 104°F (0°C to 40°C) | |
| Storage Temperature | 14°F to 140°F (-10°C to 60°C) | |
| Dimensions | 6.23 x 0.83 x 0.99 in (158 x 21 x 25 mm) | |
| Humidity | 80% max | |

TEST & MEASUREMENT | NCV

TEST & MEASUREMENT

NCV DETECTOR 50-600V AC PRO

40136N



NCV detector 50-600V AC Pro

- Features automatic power off
- Flashlight now 2X brighter
- Thinner probe tip for working with wall outlets
- Power switch (standard)
- Green LED means Power on
- Flashing red LED with beeper means voltage detected
- Low battery self test
- Silent mode
- Flash and beep rate increase as the detector gets closer to the voltage source helping the user pinpoint live circuits



TEST & MEASUREMENT | NCV

| MODEL # | STOCK # | DESCRIPTION |
|-----------------------|--|------------------------------------|
| 40136N | 59992440 | 40136N NCV Detector 48-600V AC Pro |
| AC Detection Range | 50-600V AC | |
| Safety Rating | CAT IV 600V | |
| Frequency Range | 50/60Hz | |
| Batteries | Two AAA | |
| Operating Temperature | 32°F to 104°F (0°C to 40°C) | |
| Storage Temperature | 14°F to 140°F (-10°C to 60°C) | |
| Dimensions | 6.23 x 0.83 x 0.99 in (158 x 21 x 25 mm) | |
| Humidity | 80% max | |

TEST & MEASUREMENT

40126N NCV DUAL RANGE 24-600V AC

40126N



NCV dual range 24-600V & 100-600V AC.

- Flashlight now 2X brighter
- Thinner probe tip for working with wall outlets
- Power switch (standard)
- Green LED means Power on
- Flashing red LED with beeper means voltage detected
- Low battery self test
- High voltage and low voltage mode



| MODEL # | STOCK # | DESCRIPTION |
|-----------------------|--|----------------------------------|
| 40126N | 59992240 | 40126N NCV Dual Range 24-600V AC |
| AC Detection Range | 24-600V & 100-600V AC | |
| Safety Rating | CAT IV 600V | |
| Frequency Range | 50/60Hz | |
| Batteries | Two AAA | |
| Operating Temperature | 32°F to 104°F (0°C to 40°C) | |
| Storage Temperature | 14°F to 140°F (-10°C to 60°C) | |
| Dimensions | 6.23 x 0.83 x 0.99 in (158 x 21 x 25 mm) | |
| Humidity | 80% max | |

TEST & MEASUREMENT | NCV

TEST & MEASUREMENT

NCV DETECTOR 100-600V AC

40116N



NCV detector 100-600V AC.

- Flashlight now 2X brighter
- Thinner probe tip for working with wall outlets
- Power switch (standard)
- Green LED means power on
- Flashing red LED with beeper means voltage detected
- Low battery self test



TEST & MEASUREMENT | NCV

| MODEL # | STOCK # | DESCRIPTION |
|-----------------------|--|---------------------------------|
| 40116N | 59992040 | 40116N NCV Detector 100-600V AC |
| AC Detection Range | 100-600V AC | |
| Safety Rating | CAT IV 600V | |
| Frequency Range | 50/60Hz | |
| Batteries | Two AAA | |
| Operating Temperature | 32°F to 104°F (0°C to 40°C) | |
| Storage Temperature | 14°F to 140°F (-10°C to 60°C) | |
| Dimensions | 6.23 x 0.83 x 0.99 in (158 x 21 x 25 mm) | |
| Humidity | 80% max | |

TEST & MEASUREMENT

GFCI RECEPTACLE TESTER

40022S



GFCI receptacle tester quickly identifies the most common wiring faults associated with 3-wire 120V outlets. Just plug it into the outlet and the indicator lights quickly tell you if the outlet is wired correctly. Press the red button to verify that a GFCI circuit is functioning properly.

- Tests standard 120V outlets
- Tests ground fault circuit interrupter (GFCI) outlets & circuits
- Three light indicators identify wiring faults
- Wiring legend on the top and bottom of the tester so it's always easy to see
- UL listed



| MODEL # | STOCK # | DESCRIPTION |
|---------|----------------------|--|
| 40022S | 65032040 | GFCI Receptacle Tester |
| ○●○ | Open Ground | Ground contact is not connected |
| ○○● | Open Neutral | Neutral contact is not connected |
| ○○○ | Open Hot | Hot contact is not connected |
| ●○● | Hot/Ground Reversed | Hot and ground connections are interchanged |
| ●●○ | Hot/Neutral Reversed | Hot and neutral connections are interchanged |
| ○○○ | Correct | Receptacle is wired correctly |

TEST & MEASUREMENT

RECEPTACLE TESTER

40012S



Receptacle Tester quickly identifies the most common wiring faults associated with 120V outlets. Just plug it in and the indicator lights quickly tell you if the outlet is wired correctly.

- Tests standard 120V outlets Performs 6 tests: open ground, open neutral, open hot, hot/ground reversed, hot/neutral reversed, or wired correctly
- Three light indicators identify wiring faults
- Wiring legend on the top and bottom of the tester so it's always easy to see
- UL listed



TEST & MEASUREMENT | TESTER

| MODEL # | STOCK # | DESCRIPTION |
|---------|----------------------|--|
| 40012S | 65031940 | Receptacle Tester |
| ○●○ | Open Ground | Ground contact is not connected |
| ○○● | Open Neutral | Neutral contact is not connected |
| ○○○ | Open Hot | Hot contact is not connected |
| ●○○ | Hot/Ground Reversed | Hot and ground connections are interchanged |
| ●●○ | Hot/Neutral Reversed | Hot and neutral connections are interchanged |
| ○○○ | Correct | Receptacle is wired correctly |

TEST & MEASUREMENT

PRO CONTINUITY TESTER WITH REMOTE

40040S



The Southwire 40040S provides a simple way of checking continuity on wire and cables. The bright LEDs and loud pulsating beeper provide a positive indication of continuity and polarity. A detachable remote indicator is included for tracing multiple cable runs.

- Bi-color LEDs determine polarity
- Color coded alligator clips for easy connection
- Wiring legend on tester provides simple operation
- Rugged double-molded housing



| MODEL # | STOCK # | DESCRIPTION |
|------------|----------------------|-----------------------------------|
| 40040S | 59724840 | Pro Continuity Tester with Remote |
| FUNCTION | RANGE | |
| Dimensions | 4.0 x 2.1 x 1.3 inch | |
| Weight | 0.42 lb. (191g) | |

TEST & MEASUREMENT | TESTER

TEST & MEASUREMENT

4-WAY VOLTAGE TESTER

40141S



The 4-Way Voltage Tester is a handy, pocket size tester that checks live AC voltage from 120 to 480 volts and DC voltage from 160 to 600 volts in four easy steps. The 40141S is easy to read and features a convenient, compact design.

- Tests AC voltage from 120V to 480V
- Tests DC voltage from 160V to 600V
- CAT III 600V safety rating
- Built-in test leads and handy pocket clip
- No batteries required
- Test probes conveniently store in the back of the tester and are spaced to fit standard AC outlets
- UL listed
- Built to withstand a 6-foot drop



TEST & MEASUREMENT | TESTER

| MODEL # | STOCK # | DESCRIPTION |
|------------------------|--|----------------------|
| 40141S | 65032240 | 4-Way Voltage Tester |
| Voltage LED Steps | AC: 120, 240, 277, 480 DC: 160, 330, 380, 600 | |
| AC Operating Frequency | 60Hz | |
| Safety Rating | CAT III 600V | |
| Drop Protection | 6.5 feet (2 meters) | |
| Operating Temperature | 32 °F to 104 °F (0°C to 40°C) | |
| Storage Temperature | 14 °F to 122 °F (-10°C to 50°C) | |

TEST & MEASUREMENT

930°F 12:1 IR THERMOMETER

31212S



Southwire's newest dual-laser IR thermometer, the 31212S, is designed for the professional because it's accurate, rugged, and easy-to-use. Perfect for everyday use but loaded with advanced features for ultimate flexibility. Customers appreciate the extra-large, backlit temperature display that's easy to see in almost any environment.

- Designed for the professional
- Dual-laser targeting for precise aiming
- 12:1 optics for extra-long distance accuracy
- Extra large, uncluttered, backlit temperature display
- Adjustable emissivity - higher accuracy when measuring different materials
- Displays temperature in °F or °C
- Protective carrying pouch included
- Continuous Measurement. Built-in tripod mount and LOCK Mode
- High and Low Temperature Alarms
- MAX, MIN, AVE, DIF Mode



TEST & MEASUREMENT | IR THERMOMETER

| MODEL # | STOCK # | DESCRIPTION | |
|------------------------------|--|--|----------------------------|
| 31212S | 65111840 | 930°F 12:1 IR Thermometer | |
| Measurement Range | -26°F - 932°F (-32°C - 500°C) | | |
| Working Temperature | 32°F - 122°F (0°C - 50°C) | | |
| Working Relative Humidity | <90% RH (non-condensing) | | |
| Storage Temperature | -4°F - 140°F (-20°C - 60°C) | | |
| Accuracy | SURFACE TEMPERATURE | ACCURACY | AMBIENT TEMPERATURE |
| | -26°F ≤ t ≤ 32°F | +/- (3.6°F + 0.1°F/°F) | 69.8°F - 77 °F |
| | 32°F < t ≤ 932°F | +/- 3.6°F or 1.8% of reading, whichever is greater | |
| | -32°C ≤ t ≤ 0°C | +/- (1.8°C + 0.1°C/°C) | 21°C - 25 °C |
| 0°C < t ≤ 500°C | +/- 1.8°C or 1.8% of reading, whichever is greater | | |
| D:S Ratio (Distance to Spot) | 12:1 (Applies for 90% for the measuring signal) | | |
| Emissivity | 0.1 ~ 1.0 (Adjustable) | | |
| Display Resolution | 0.1°F (0.1°C) | | |

TEST & MEASUREMENT

750°F 10:1 IR THERMOMETER

31011F



When you need an IR thermometer that's simple and economical, the Southwire 31011F is the right model for you. Just point-and-shoot for accurate and repeatable temperature measurements around the house or on the job.

- Simple & economical
- Single-laser targeting
- 10:1 optics for long distance accuracy
- Fixed emissivity (0.95)
- Displays temperature in °F or C
- Low-battery indicator
- Built for the Work Environment: 6-Ft Drop Rating



TEST & MEASUREMENT | IR THERMOMETER

| MODEL # | STOCK # | DESCRIPTION | | |
|------------------------------|---|---------------------------|--|--|
| 31011F | 65111640 | 750°F 10:1 IR Thermometer | | |
| Measurement Range | -4°F - 752°F (-20°C - 400°C) | | | |
| Working Temperature | 32°F - 122°F (0°C - 50°C) | | | |
| Working Relative Humidity | <90% RH (non-condensing) | | | |
| Storage Temperature | -4°F - 140°F (-20°C - 60°C) | | | |
| Accuracy | SURFACE TEMPERATURE | | ACCURACY | |
| | -4°F ≤ t ≤ 32°F | | +/- (4°F + 0.1°F/°F) | |
| | 32°F < t ≤ 752°F | | +/- 4°F or +/- 2% of reading, whichever is greater | |
| | -20°C ≤ t ≤ 0°C | | +/- (2°C + 0.1°C/°C) | |
| | 0°C < t ≤ 400°C | | +/- 2.0°C or 2% of reading, whichever is greater | |
| D:S Ratio (Distance to Spot) | 10:1 (Applies for 90% for the measuring signal) | | | |
| Emissivity | Fixed at 0.95 | | | |
| Display Resolution | 0.1°F (0.1°C) | | | |
| | | | 69.8°F - 77 °F | |
| | | | 21°C - 25 °C | |

TEST & MEASUREMENT

41210S CIRCUIT BREAKER FINDER WITH GFCI

41210S



The circuit breaker finder pinpoints the specific breaker powering the circuit being worked on. Eliminates guessing and unwanted power outages caused by tripping the wrong breaker.

- Advanced design quickly and reliably pinpoints single breaker without service interruption
- Tests GFCI outlets
- For use on energized circuits
- Includes:
 - 41210S Transmitter and Receiver
 - 3-prong to 2-prong adapter
 - 9 volt battery
- Available accessory: 60030S Adapter Kit

| MODEL # | STOCK # | DESCRIPTION |
|------------|--------------------------------|----------------------------------|
| 41210S | 58292140 | Circuit Breaker Finder with GFCI |
| Dimensions | 7.56 in. x 2.52 in. x 1.65 in. | |

TEST & MEASUREMENT

TYPE K TEMPERATURE CLAMP

60020S



The 60020S Type K temperature clamp allows quick maintenance checks on heating and air-conditioning systems. It's the perfect accessory for clamp meters and multimeters with a temperature function.

- For multimeters, clamp meters and thermometers that accept a type K temperature probe
- Spring-loaded jaw clamps around heating/cooling pipes up to 1.5" in diameter
- Temperature range: -4° to 200°F (-20° to 93°C)

| MODEL # | STOCK # | DESCRIPTION |
|---------|----------|--------------------------|
| 60020S | 58293140 | Type K Temperature Clamp |

TEST LEAD KIT

60010S



60010S Test lead kit includes universal replacement leads for all Southwire meters.

- UL listed
- CAT IV 600V/CAT III 1000V
- Includes alligator clip attachments (CAT III 600V)

| MODEL # | STOCK # | DESCRIPTION |
|---------|----------|---------------|
| 60010S | 58292940 | Test Lead Kit |

ADAPTER KIT FOR CIRCUIT BREAKER FINDER

60030S



This adapter kit includes a light socket adapter that allows for rapid location of circuit breakers connected to lighting fixtures. Also includes alligator clips that allow the transmitter to be connected to unterminated branch circuit wiring.

- For use with 41210S circuit breaker finder

| MODEL # | STOCK # | DESCRIPTION |
|---------|----------|--|
| 60030S | 58292240 | Adapter Kit for Circuit Breaker Finder |

TEST & MEASUREMENT

ELECTRICAL TEST KIT

10037K



The Southwire electrical test kit combines three of Southwire's most popular test and measurement products into one convenient kit. Ideal for household repairs and electrical troubleshooting.

- 10031S Manual ranging multimeter is CAT III 300V safety rated. It measures AC/DC voltage, resistance, and DC current. Also tests batteries and continuity.
- 40117N Non-contact AC voltage detector has a 90-1000V detection range, CAT IV 1000V safety rating, automatic self test, and features a bright LED flashlight
- 40012S Receptacle tester verifies wiring errors in standard 3-wire AC outlets. Just plug it into the receptacle. LED indicators and wiring legend identify faults
- All products are UL listed and meet the latest UL safety standards
- All products are built to withstand a 6-foot drop

| MODEL # | STOCK # | DESCRIPTION |
|---------|----------|---------------------|
| 10037K | 65031340 | Electrical Test Kit |

| MODEL # | STOCK # | DESCRIPTION | |
|---------------|---------------------|---------------------------|------------------------------|
| 10031S | 65031140 | Manual-Ranging Multimeter | |
| FEATURE | RANGE | MAX. RESOLUTION | MAX. ACCURACY (% OF READING) |
| AC Voltage | 600V | 100mV | +/- (1.2%+10) |
| DC Voltage | 600V | 0.1mV | +/- (0.8%+8) |
| DC Current | 10A | 1µA | +/- (1.0%+5) |
| Resistance | 2.000MΩ | 0.1Ω | +/- (0.8%+5) |
| Continuity | | 0.1Ω | |
| Battery Test | 1.5V | 1mV | +/- (1.0%+5) |
| Battery Test | 9V | 10mV | +/- (1.0%+5) |
| Dimensions | 6.1 x 2.9 x 2.1 in. | | |
| Weight | 0.6lb. | | |
| Safety Rating | CAT III 300V | | |

| MODEL # | STOCK # | DESCRIPTION |
|-------------------------|--------------------|---------------------------|
| 40117N | N/A | 1000V AC Voltage Detector |
| Detection Voltage Range | 90V AC to 1000V AC | |
| Frequency Range | 50/60Hz | |
| Safety Rating | CAT IV 1000V | |

| MODEL # | STOCK # | DESCRIPTION |
|------------|--|-------------------|
| 40012S | 65031940 | Receptacle Tester |
| Identifies | Open Ground, Open Neutral, Open Hot, Hot/Ground Reversed, Hot/Neutral Reversed, Correct Wiring | |



Southwire™

TOOLS & EQUIPMENT CATALOG

GET SOCIAL WITH US:



**/SOUTHWIRETOOLS
/SOUTHWIRETOOLSLATINO**



@SOUTHWIRETOOLS



@SOUTHWIRETOOLS



SOUTHWIRETOOLS

SOUTHWIRE.COM | 1-855-SWTOOLS

All Trademarks or Registered Trademarks (TM/®) are owned or licensed by Southwire Company.
Any other TM/® - Trademark or Registered Trademark of Southwire Company.