



Southwire™

PVC FITTINGS & ELBOWS

CATALOG

**BUILT FOR DURABILITY.
BUILT FOR RELIABILITY.
BUILT FOR WORK.™**

SOUTHWIRE.COM

END CAPS



1081

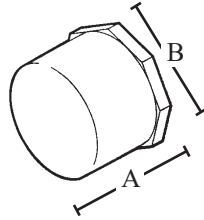

FEATURES

- High tensile and impact strength
- Easy to install slip fit

APPLICATIONS

- Cap off pipe openings; allows access for future expansions or service
- Capping provides a finished look and inhibits damage from moisture and other elements

STANDARD MATERIAL

- PVC

PART #	SIZE	MASTER QTY.	WEIGHT/ CASE (LBS.)	A	B
1081	1/2"	100	2	1"	1.0625"
1082	3/4"	100	4	1.25"	1.3125"
1083	1"	50	4	1.4375"	1.625"
1084	1-1/4"	25	2	1.50"	2"
1085	1-1/2"	25	3	1.625"	2.25"
1086	2"	50	8	1.75"	2.75"
1087	2-1/2"	25	7	2.125"	3.50"
1088	3"	25	13	2.25"	4"
1089	3-1/2"	25	15	2.3125"	4.625"
1090	4"	25	19	2.50"	5.0625"
1090A	5"	25	12	2.50"	6.125"
1090B	6"	10	19	3.3125"	7.25"

SERVICE ENTRANCE CAPS



1111

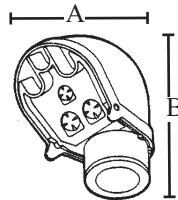

FEATURES

- High tensile and impact strength
- Weather resistant

APPLICATIONS

- Installed on a vertical conduit, usually outdoors, to receive open wires from an electrical service line
- Sometimes called a weather head, it prevents rainwater from entering the conduit

STANDARD MATERIAL

- PVC

PART #	SIZE	MASTER QTY.	WEIGHT/ CASE (LBS.)	A	B
1111	1/2"	10	2	3"	3"
1112	3/4"	10	2	3"	3"
1113	1"	20	4	3.50"	3.50"
1114	1-1/4"	20	10	5.25"	4.25"
1115	1-1/2"	20	20	6.75"	5.75"
1116	2"	5	5	6.75"	5.75"
1117	2-1/2"	5	21	14"	9"
1118	3"	5	19	14"	9"
1119	3-1/2"	5	42	---	---
1120	4"	1	14	17"	13.50"

END BELLS



1121

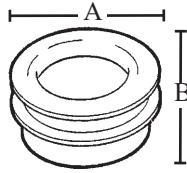

FEATURES

- High tensile and impact strength
- Protects wiring being pulled through the vault wall

APPLICATIONS

- Used in concrete vault walls to provide a smooth, safe entrance to the conduit outside

STANDARD MATERIAL

- PVC

PART #	SIZE	MASTER QTY.	WEIGHT/ CASE (LBS.)	A	B
1121	1/2"	100	2	1.25"	.75"
1122	3/4"	100	3	1.50"	1"
1123	1"	50	2	1.75"	1.25"
1124TZ	1-1/4"	50	4	2.125"	1.3125"
1125TZ	1-1/2"	50	5	2.50"	1.5625"
1126TZ	2"	40	5	2.8125"	1.5625"
1127TZ	2-1/2"	30	6	3.375"	1.875"
1128TZ	3"	50	19	4.125"	2.0625"
1129TZ	3-1/2"	50	13	4.625"	2.25"
1130	4"	50	17	5.125"	2.375"
1130A	5"	25	20	6.375"	2.4375"
1130B	6"	15	18	7.375"	2.875"

METER OFFSET



1094

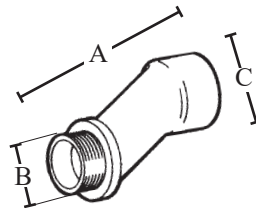

FEATURES

- High tensile and impact strength
- An offset is needed to move the path of the conduit away from a wall into the holes of an electrical meter box

APPLICATIONS

- Use to connect a conduit to a meter box

STANDARD MATERIAL

- PVC

PART #	SIZE	MASTER QTY.	WEIGHT/ CASE (LBS.)	A	B	C
1094	1-1/4"	15	3	3.50	1.625"	2"
1096	2"	8	2	3.50	2.3125"	2.1875"

COUPLINGS



1011

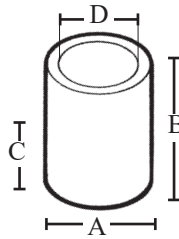

FEATURES

- The fitting consist of two female ends with a center stop
- Both pieces of pipe should seat at the stop for proper positioning

APPLICATIONS

- A connector used to join lengths of conduit pipe

STANDARD MATERIAL

- PVC

PART #	SIZE	MASTER QTY.	WEIGHT/ CASE (LBS.)	A	B	C	D
1011TZ	1/2"	200	6	1.0625"	1.50"	.625"	.875"
1012TZ	3/4"	125	6	1.3125"	1.5625"	.625"	1.062"
1013	1"	70	6	1.625"	2"	1"	1.3125"
1014	1-1/4"	40	5	2"	2.125"	1"	1.6875"
1015	1-1/2"	30	5	2.25"	2.375"	1.125"	1.9375"
1016	2"	40	5	2.6875"	2.4375"	1.25"	2.375"
1017	2-1/2"	20	8	3.25"	3.50"	1.75"	2.875"
1018	3"	40	25	4"	3.875"	1.8125"	3.50"
1019	3-1/2"	30	23	4.125"	4"	1.9375"	4"
1020	4"	20	20	5"	4.1875"	2"	4.50"
1020A	5"	10	15	6.125"	5.375"	2.50"	5.625"
1020B	6"	8	19	7.25"	6.375"	3"	6.625"

FEMALE ADAPTERS



1022

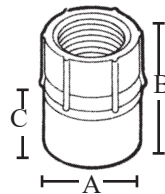

FEATURES

- The fitting consists of two female ends, one end is threaded and the other is solvent weld
- Both ends fit the same diameter conduit

APPLICATIONS

- A connector often used to transition threaded metal conduit to PVC conduit
- Can also be used to join PVC to PVC

STANDARD MATERIAL

- PVC

PART #	SIZE	MASTER QTY.	WEIGHT/ CASE (LBS.)	A	B	C
1021	1/2"	200	6	1"	1.4375"	.6875"
1022	3/4"	125	6	1.25"	1.625"	.6875"
1023	1"	70	5	1.5625"	1.875"	.875"
1024	1-1/4"	40	5	2"	1.9375"	.9375"
1025	1-1/2"	30	4	2.25"	2.125"	.9375"
1026	2"	40	7	2.6875"	2.125"	.9375"
1027	2-1/2"	20	7	3.3125"	3"	1.3125"
1028	3"	40	22	4"	3.0625"	1.25"
1029	3-1/2"	30	18	4.50"	3"	1.1875"
1030TZ	4"	20	16	5"	3.25"	1.375"
1030A	5"	10	13	7.25"	4.375"	1.625"
1030B	6"	8	15	9.3125"	7"	2.25"

TERMINAL ADAPTERS



1031



1036

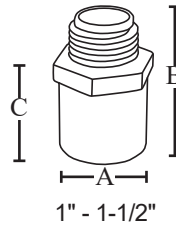

1" - 1-1/2"



1/2" - 3/4" &
2" - 6"



FEATURES

- The fitting consists of one solvent weld female end and one threaded male end
- Both ends will fit the same diameter conduit

APPLICATIONS

- A connector used to transition from plain end PVC conduit to a threaded metal or PVC female bell
- Can also be used to connect PVC conduit to a box or other threaded body with the use of a locknut (sold separately)

STANDARD MATERIAL

- PVC

PART #	SIZE	MASTER QTY.	WEIGHT/ CASE (LBS.)	A	B	C
1031	1/2"	200	6	1.0625"	1.6875"	1.125"
1032	3/4"	125	6	1.25"	1.75"	1.1875"
1033	1"	70	5	2.1875"	1.625"	1.50"
1034TZ	1-1/4"	40	4	2"	2.125"	1.3125"
1035TZ	1-1/2"	30	3	2"	2.0625"	1.3125"
1036	2"	40	6	2.6875"	2.1875"	1.375"
1037	2-1/2"	20	7	3.3125"	2.875"	2"
1038	3"	40	18	3.9375"	3"	2.1875"
1039	3-1/2"	30	18	4.50"	3.1875"	2.5625"
1040TZ	4"	20	15	5"	3.4375"	2.5625"
1040A	5"	10	14	6.25"	4.75"	3"
1040B	6"	8	10	7.3125"	4.9375"	2.6875"

POLY PLUGS



1206



FEATURES

- High tensile and impact strength
- Creates tight seal

APPLICATIONS

- Use threaded male end to close end of fitting; allows flexibility for future expansion or configuration changes

STANDARD MATERIAL

- PVC

PART #	SIZE	MASTER QTY.	WEIGHT/ CASE (LBS.)
1206	2"	70	6
1207	3"	70	10
1208	4"	90	20
1208A	5"	45	15
1208B	6"	30	10

REDUCERS



1132

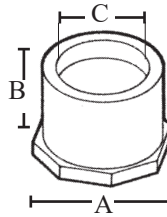

FEATURES

- Male and female elements of the bushing are solvent weld
- Flush style; suitable for underground use

APPLICATIONS

- A bushing designed to fit into a bell end or female fitting to reduce from one diameter to the next smaller conduit diameter

STANDARD MATERIAL

- PVC

PART #	SIZE	MASTER QTY.	WEIGHT/ CASE (LBS.)	A	B	C
1132	3/4" X 1/2"	100	2	1.05"	1"	.852"
1133	1" X 3/4"	100	4	1.315"	1.18"	1.064"
1134	1-1/4" X 1"	50	4	1.66"	1.42"	1.33"
1135	1-1/2" X 1-1/4"	50	4	1.90"	1.37"	1.677"
1136	2" X 1-1/2"	25	5	2.375"	1.60"	1.918"
1137	2-1/2" X 2"	25	7	2.875"	1.90"	2.393"
1138	3" X 2-1/2"	25	10	3.50"	2.25"	2.89"
1139	4" X 3"	20	11	4.50"	2.60"	3.515"
1140	4" X 3-1/2"	20	9	4.50"	2.60"	4.015"

BOX ADAPTERS



1211



FEATURES

- Easy installation – the cylinder end protrudes through a hole in the box wall and is solvent welded to a female fitting on the exterior of a box or enclosure

APPLICATIONS

- Adapter can be used with the hub inside a box or enclosure

STANDARD MATERIAL

- PVC

PART #	SIZE	MASTER QTY.	WEIGHT/ CASE (LBS.)
1211	1/2"	100	2
1212	3/4"	100	2
1213	1"	100	4
1214	1-1/4"	50	3
1215	1-1/2"	50	3
1216	2"	25	3
1217	2-1/2"	10	2
1218	3"	10	3
1219	3-1/2"	10	4
1220	4"	10	4

TWO HOLE PIPE STRAPS



1061

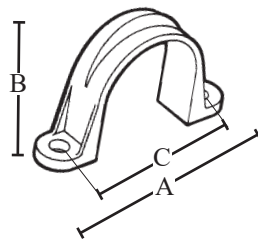

FEATURES

- Two hole construction enables greater load bearing capacity
- Holes in the feet of the strap for mounting with screws or nails

APPLICATIONS

- A U-shaped conduit support device used to anchor conduit to interior or exterior surfaces
- Designed to handle the extra thickness of PVC conduit systems

STANDARD MATERIAL

- PVC

PART #	SIZE	MASTER QTY.	WEIGHT/ CASE (LBS.)	A	B	C
1061	1/2"	300	2	2.1875"	1"	1.6875"
1062	3/4"	200	2	2.50"	1.25"	2"
1063	1"	200	2	2.8125"	1.50"	2"
1064	1-1/4"	200	3	3.125"	1.8125"	2.50"
1065	1-1/2"	200	4	3.375"	2.125"	2.6875"
1066	2"	200	6	4"	2.5625"	3.3125"
1067	2-1/2"	100	7	5.50"	3"	4.5625"
1068	3"	100	8	6"	3.5625"	5.125"
1070	4"	100	9	7"	4.625"	6"

PVC OFFSETS

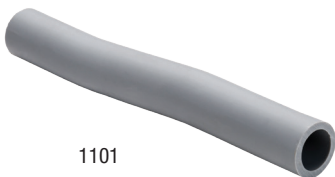

1101

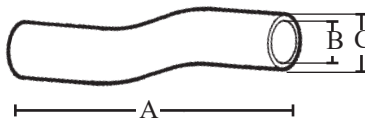

FEATURES

- High tensile and impact strength
- Non-conductive; will not rust or corrode

APPLICATIONS

- Plain end section of conduit enables directional changes around obstacles and compensates for centerline differences in two conduit runs

STANDARD MATERIAL

- PVC

PART #	SIZE	MASTER QTY.	WEIGHT/ CASE (LBS.)	A	B	C
1101	1/2"	25	3	6.375"	.625"	.875"
1102	3/4"	25	3	6.375"	.75"	1.0625"

Special radius sizes available by request

45° BELL END ELBOWS

SCHEDULE 40 PVC



1251

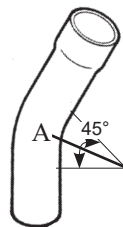

PART #	SIZE	MASTER QTY.	WEIGHT/ CASE (LBS.)	A MIN. RADIUS
1251	1/2"	50	5	4
1252	3/4"	25	4	4.50
1253	1"	25	7	5.75
1254	1-1/4"	25	9	7.25
1255	1-1/2"	20	11	8.25
1256	2"	10	8	9.50
1257	2-1/2"	20	30	10.50
1258	3"	8	20	13
1259	3-1/2"	5	15	15
1260	4"	20	87	16
1260A	5"	1	5	24
1260B	6"	1	7	30

FEATURES

- A section of Schedule 40 PVC conduit which has been heated and bent to enable a 45° directional change in a conduit run
- A standard conduit bell is formed on one end while the other end is a spigot (plain) end
- Both ends are solvent weld

APPLICATIONS

- Can be used above ground or buried; suitable for use in concrete encasement

STANDARD MATERIAL

- Schedule 40 PVC

90° BELL END ELBOWS

SCHEDULE 40 PVC



1241

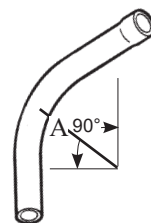

PART #	SIZE	MASTER QTY.	WEIGHT/ CASE (LBS.)	A MIN. RADIUS
1241TZ	1/2"	50	7	4
1242	3/4"	35	8	4.50
1243	1"	20	8	5.75
1244	1-1/4"	30	20	7.25
1245TZ	1-1/2"	30	25	8.25
1246TZ	2"	15	27	9.50
1247	2-1/2"	18	41	10.50
1248	3"	14	56	13
1249	3-1/2"	12	64	15
1250	4"	10	70	16
1250A	5"	1	8	24
1250B	6"	1	9	30

FEATURES

- A section of Schedule 40 PVC conduit which has been heated and bent to enable a 90° directional change in a conduit run
- A standard conduit bell is formed on one end while the other end is a spigot (plain) end
- Both ends are solvent weld

APPLICATIONS

- Can be used above ground or buried; suitable for use in concrete encasement

STANDARD MATERIAL

- Schedule 40 PVC

30° PLAIN END ELBOWS

SCHEDULE 40 PVC



1261

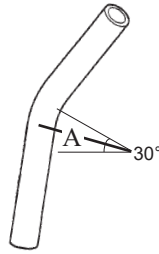

FEATURES

- A section of Schedule 40 PVC conduit which has been heated and bent to enable a 30° directional change in a conduit run
- Both ends of the bend are spigot (plain) end
- Both ends are solvent weld

APPLICATIONS

- Can be used above ground or buried; suitable for use in concrete encasement

STANDARD MATERIAL

- Schedule 40 PVC

PART #	SIZE	MASTER QTY.	WEIGHT/CASE (LBS.)	A MIN. RADIUS
1261	1/2"	50	6	4
1262	3/4"	25	3	4.50
1263	1"	20	4	5.75
1264	1-1/4"	25	7	7.25
1265	1-1/2"	20	9	8.25
1266	2"	10	6	9.50
1267	2-1/2"	20	24	10.50
1268	3"	8	15	13
1269	3-1/2"	5	26	15
1270	4"	20	76	16
1270A	5"	30	131	24
1270B	6"	25	92	30

45° PLAIN END ELBOWS

SCHEDULE 40 PVC



1051

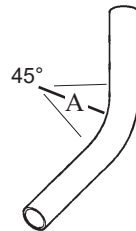

FEATURES

- Both ends of the bend are spigot (plain) end
- Both ends are solvent weld

APPLICATIONS

- Can be used above ground or buried; suitable for use in concrete encasement

STANDARD MATERIAL

- Schedule 40 PVC

PART #	SIZE	MASTER QTY.	WEIGHT/CASE (LBS.)	A MIN. RADIUS
1051TZ	1/2"	50	5	4
1052	3/4"	25	4	4.50
1053	1"	20	5	5.75
1054	1-1/4"	25	10	7.25
1055TZ	1-1/2"	20	11	8.25
1056	2"	10	8	9.50
1057	2-1/2"	20	30	10.50
1058	3"	8	19	13
1059	3-1/2"	5	16	15
1060	4"	20	86	16
1060A	5"	1	7	24
1060B	6"	1	10	30

90° PLAIN END ELBOWS

SCHEDULE 40 PVC

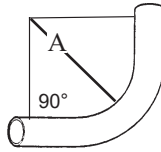
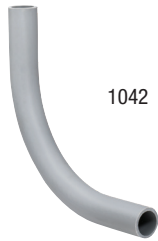

FEATURES

- Longer radius than "standard" UL elbows
- Both ends of the bend are spigot (plain) end
- Both ends are solvent weld

APPLICATIONS

- Can be used above ground or buried; suitable for use in concrete encasement

STANDARD MATERIAL

- Schedule 40 PVC

PART #	SIZE	MASTER QTY.	WEIGHT/ CASE (LBS.)	A MIN. RADIUS
1041TZ	1/2"	50	8	4
1042	3/4"	35	8	4.50
1043TZ	1"	20	8	5.75
1044	1-1/4"	30	20	7.25
1045TZ	1-1/2"	30	25	8.25
1046TZ	2"	15	20	9.50
1047	2-1/2"	18	44	10.50
1048	3"	14	52	13
1049	3-1/2"	12	60	15
1050TZ	4"	10	68	16
1050A	5"	30	376	24
1050B	6"	25	469	30

TWO PIECE EXPANSION COUPLINGS

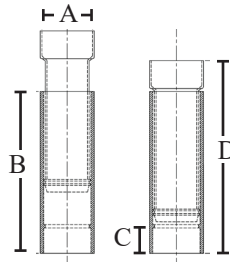
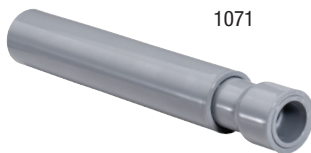

FEATURES

- Meets NEMA TC 3 Requirements
- Seal is watertight

APPLICATIONS

- For use with Schedule 40 & Schedule 80 PVC conduit
- Compensates for temperature related length changes in exposed applications

STANDARD MATERIAL

- PVC

PART #	SIZE	MASTER QTY.	WEIGHT/ CASE (LBS.)	A	B	C	D
1071	1/2"	25	9	.875"	7"	.6875"	8.125"
1072	3/4"	10	4	1.0625"	7"	.875"	8.125"
1073	1"	10	5	1.3125"	7.0625"	1"	8.375"
1074	1-1/4"	5	4	1.6875"	7.625"	1"	9"
1075	1-1/2"	5	5	1.9375"	7.5625"	1.125"	9"
1076	2"	25	33	2.375"	7.6875"	1.1875"	9.25"
1077	2-1/2"	12	43	2.875"	1'	1.875"	1' & 2.9375"
1078	3"	12	39	3.50"	1'	1.875"	1' & 2.3125"
1079	3-1/2"	9	49	4"	1' & .375"	2"	1' & 2.875"
1080	4"	6	29	4.50"	1' & .3125"	2.125"	1' & 2.875"

CONDUIT BODIES

LB TYPE



1141

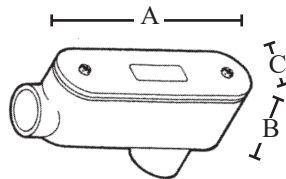

FEATURES

- Lightweight; enables easy installation in small areas
- Rectangular shaped conduit body with a removable cover
- One entrance hub at the opposite end in the back (floor)

APPLICATIONS

- Use for a change of direction of the conduit run with the back hub usually exiting through a wall

STANDARD MATERIAL

- PVC
- Screws - Zinc plated steel

PART #	SIZE	MASTER QTY.	WEIGHT/ CASE (LBS.)	A	B	C
1141	1/2"	25	5	4.1875"	1.4375"	1.3125"
1142	3/4"	15	4	4.9375"	1.625"	1.50"
1143	1"	10	4	5.875"	2"	1.75"
1144	1-1/4"	10	8	7.5625"	2.375"	2.50"
1145	1-1/2"	10	9	8.5625"	2.75"	2.625"
1146	2"	5	8	9.8125"	3.375"	3.125"
1147	2-1/2"	5	24	1' 3"	4.5625"	4.625"
1148	3"	5	25	1' 3.0625"	4.5625"	4.625"
1149	3-1/2"	4	26	1' 4.1875"	5.50"	5.625"
1150	4"	4	26	1' 4.1875"	5.50"	5.625"

C TYPE



1181

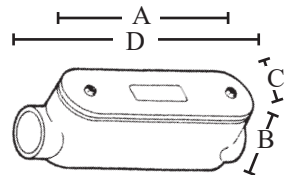

FEATURES

- Rectangular shaped conduit body with a removable cover
- Conduit body contains two conduit hubs, one in each end wall

APPLICATIONS

- Use as a connector in straight line installations that allow access for wire pulling and limited wire splices as approved by the National Electrical Code (NEC)

STANDARD MATERIAL

- PVC
- Screws - Zinc plated steel

PART #	SIZE	MASTER QTY.	WEIGHT/ CASE (LBS.)	A	B	C	D
1181	1/2"	25	5	4"	1.50"	1.3125"	4.625"
1182	3/4"	15	4	4.625"	1.6875"	1.50"	5.375"
1183	1"	10	4	5.375"	2"	1.75"	6.5625"
1184	1-1/4"	10	7	7.1875"	2.50"	2.50"	8.1875"
1185	1-1/2"	10	10	8"	2.8125"	2.625"	9.25"
1186	2"	5	8	9.50"	3.375"	3.125"	10.375"
1187	2-1/2"	5	22	1' .875"	4.625"	4.625"	1' 7"
1188	3"	5	26	1' .875"	4.625"	4.625"	1' 7"
1189	3-1/2"	4	15	1' 1.75"	5.5625"	5.5625"	1' 8.375"
1190	4"	4	30	1' 1.875"	5.5625"	5.5625"	1' 8.1875"

CONDUIT BODIES

LL TYPE



1151

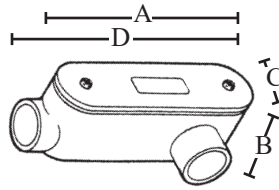

FEATURES

- Rectangular shaped conduit body with a removable cover
- Conduit body contains two conduit hubs
- Facing the cover side with the end wall hub pointing up, the second hub is in the left side wall at the opposite end of the fitting

APPLICATIONS

- Use for a 90° change of direction of the conduit run

STANDARD MATERIAL

- PVC
- Screws - Zinc plated steel

PART #	SIZE	MASTER QTY.	WEIGHT/ CASE (LBS.)	A	B	C	D
1151	1/2"	25	5	4.25"	1.4375"	1.3125"	4"
1152	3/4"	15	4	4.9375"	1.625"	1.50"	4.625"
1153	1"	10	4	6"	2"	1.75"	5.375"
1154	1-1/4"	10	8	7.625"	2.4375"	2.4375"	7.1875"
1155	1-1/2"	10	10	8.5625"	2.8125"	2.625"	8"
1156	2"	5	8	9.875"	3.4375"	3.0625"	9.50"
1157	2-1/2"	5	25	1' 2.9375"	4.625"	4.625"	1' .75"
1158	3"	5	27	1' 3"	4.625"	4.625"	1' .8125"
1159	3-1/2"	4	30	1' 4.1875"	5.50"	5.625"	1' .8125"
1160	4"	4	29	1' 3.9375"	5.50"	5.625"	1' .8125"

LR TYPE



1161

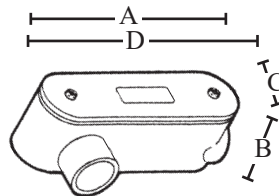

FEATURES

- Rectangular shaped conduit body with a removable cover
- Conduit body contains two conduit hubs
- Facing the cover side with the end wall hub pointing up, the second hub is in the right side wall at the opposite end of the fitting

APPLICATIONS

- Use for a 90° change of direction of the conduit run

STANDARD MATERIAL

- PVC
- Screws - Zinc plated steel

PART #	SIZE	MASTER QTY.	WEIGHT/ CASE (LBS.)	A	B	C	D
1161	1/2"	25	5	4"	1.4375"	1.3125"	4.25"
1162	3/4"	15	4	4.625"	1.625"	1.50"	4.9375"
1163	1"	10	4	5.375"	2"	1.75"	6"
1164	1-1/4"	10	8	7.1875"	2.4375"	2.4375"	7.625"
1165	1-1/2"	10	10	8"	2.8125"	2.625"	8.5625"
1166	2"	5	8	9.50"	3.4375"	3.0625"	9.875"
1167	2-1/2"	5	25	1' .75"	4.625"	4.625"	1' 2.9375"
1168	3"	5	27	1' .8125"	4.625"	4.625"	1' 3"
1169	3-1/2"	4	29	1' .8125"	5.50"	5.625"	1' 3.9375"
1170	4"	4	30	1' .8125"	5.50"	5.625"	1' 4.1875"

CONDUIT BODIES

T TYPE



1171

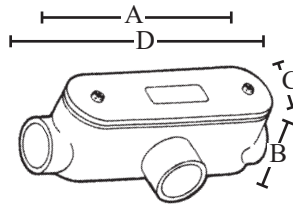

FEATURES

- Rectangular shaped conduit body with a removable cover
- Conduit body contains three conduit hubs, one in each end wall and one at 90° in the middle of the side wall

APPLICATIONS

- Allows 3-way inline access in conduit systems

STANDARD MATERIAL

- PVC
- Screws - Zinc plated steel

PART #	SIZE	MASTER QTY.	WEIGHT/ CASE (LBS.)	A	B	C	D
1171TZ	1/2"	25	5	4"	1.50"	1.3125"	4.625"
1172TZ	3/4"	15	4	4.625"	1.6875"	1.50"	5.375"
1173TZ	1"	10	4	5.375"	2"	1.75"	6.5625"
1174TZ	1-1/4"	10	8	7.1875"	2.50"	2.50"	8.1875"
1175TZ	1-1/2"	10	10	8"	2.8125"	2.625"	9.25"
1176TZ	2"	5	8	9.50"	3.375"	3.125"	10.375"
1177TZ	2-1/2"	2	12	1' .875"	4.625"	4.625"	1' 7"
1178TZ	3"	2	7	1' .875"	4.625"	4.625"	1' 7"
1179TZ	3-1/2"	1	9	1' 1.75"	5.5625"	5.5625"	1' 8.375"
1180	4"	1	9	1' 1.875"	5.5625"	5.5625"	1' 8.1875"

E TYPE



1191

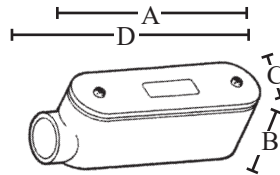

FEATURES

- Rectangular shaped conduit body with a removable cover and one hub
- Conduit body contains one conduit hub for solvent cementing

APPLICATIONS

- Stackable to most oblong bodies without cutting into existing system
- Use as a terminator body at the end of a conduit run

STANDARD MATERIAL

- PVC
- Screws - Zinc plated steel

PART #	SIZE	MASTER QTY.	WEIGHT/ CASE (LBS.)	A	B	C	D
1191	1/2"	25	5	4"	1.4375"	1.3125"	4.25"
1192	3/4"	15	4	4.625"	1.625"	1.50"	4.9375"
1193	1"	10	4	5.375"	2"	1.75"	6"
1194	1-1/4"	10	8	7.1875"	2.4375"	2.4375"	7.625"
1195	1-1/2"	10	9	8"	2.8125"	2.625"	8.5625"
1196	2"	5	8	9.50"	3.4375"	3.0625"	9.875"
1197	2-1/2"	5	20	1' .75"	4.625"	4.625"	1' 2.9375"
1198	3"	5	22	1' .8125"	4.625"	4.625"	1' 3"
1199	3-1/2"	4	21	1' .8125"	5.50"	5.625"	1' 4.1875"
1199A	4"	4	27	1' .8125"	5.50"	5.625"	1' 3.9375"

EZLB™ SERVICE ENTRANCE CONDUIT BODY

PVC



EZLB200



EZLB200



PART #	SIZE	MASTER QTY.
EZLB200	2"	2

FEATURES

- Patented, 3-piece design provides additional room to maneuver wire into place
- Split body design eliminates pinch points
- Design allows easy installation and eliminated wire damage
- Includes gasket for wet locations and 2" collar to connect to PVC conduit

APPLICATIONS

- Use for service entrance into a building or structure.

STANDARD MATERIAL

- Molded PVC

CERTIFICATIONS

- cULus Listed

PULL ELBOWS



1091

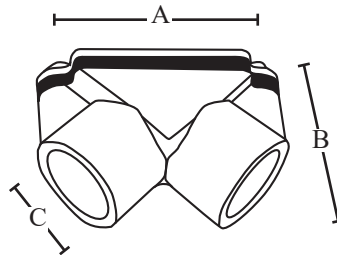

PART #	SIZE	MASTER QTY.	WEIGHT/ CASE (LBS.)	A	B	C
1091	1/2"	75	7	2.125"	1.50"	.875"
1092	3/4"	50	6	2.50"	1.625"	1.0625"

FEATURES

- Meets NEMA TC 3 requirements

APPLICATIONS

- Enables sharp 90° turns in conduit where wires must be continuously pulled around the turn
- Smooth, defect free interior ensures wires will not be damaged from abrasion
- Not used for wire splices

STANDARD MATERIAL

- PVC
- Gasket - Closed cell rubber
- Screws - Zinc plated steel

ROUND JUNCTION BOX



1239

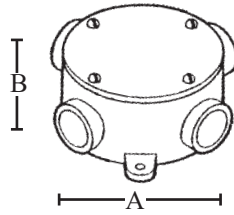

FEATURES

- NEMA 4/4x rated
- A 4" round enclosure with four entrance hubs which can be surface mounted to a wall or ceiling

APPLICATIONS

- Use to terminate a conduit run or join two to four conduits at a common point; allows space for wire splices
- Four screws secure a blank cover and gasket to the box

STANDARD MATERIAL

- PVC
- Screws - Zinc plated steel

PART #	SIZE	MASTER QTY.	WEIGHT/CASE (LBS.)	A	B
1239	1/2" & 3/4"	15	10	4.0625"	1.875"

JUNCTION BOXES



1221

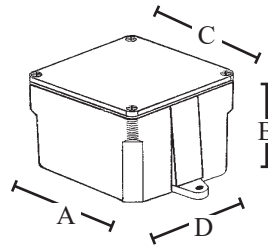

FEATURES

- NEMA 3 rated where indicated
- A surface mounted enclosure without entrance hubs which allows multiple conduits to be connected and wire splices made within

APPLICATIONS

- Appropriate round hole for conduit entrance must be cut
- Male adapters or box adapters may be used to secure conduit to the box
- May be concrete encased or buried (not warranted or listed to be watertight for all circumstances)

STANDARD MATERIAL

- PVC
- Screws - Zinc plated steel

PART #	INSIDE DIMENSION	MASTER QTY.	WEIGHT/CASE (LBS.)	A	B	C	D
1221*	4" X 4" X 2"	10	7	4.375"	2.375"	4.375"	4.375"
1222*	4" X 4" X 4"	10	11	4.25"	4.375"	4.25"	4.25"
1223*	4" X 4" X 6"	10	15	4.25"	6.3125"	4.25"	4.25"
1224*	5" X 5" X 2"	10	9	5.25"	2.3125"	5.25"	5.25"
1225TZ*	6" X 6" X 4"	10	23	6.375"	4.375"	6.75"	6.375"
1226*	6" X 6" X 6"	5	14	6.375"	6.3125"	6.6875"	6.375"
1227*	8" X 8" X 4"	5	18	8.50"	4.50"	8.875"	8.50"
1228	8" X 8" X 6"	4	18	8.3125"	6.4375"	9"	8.3125"
1229*	8" X 8" X 7"	4	21	8.75"	7.75"	9"	8.75"
1230TZ*	12" X 12" X 4"	2	14	12.50"	4.4375"	12.875"	12.50"
1231*	12" X 12" X 6"	2	18	12.375"	6.50"	12.875"	12.375"
1232*	16" X 14" X 6"	1	12	16.75"	6.75"	17.125" X 15.125"	14.75"
1233**	24" X 18" X 8"	1	23	24.125"	8.25"	24.25" X 18.75"	18.25"
1234†	24" X 24" X 8"	1	36	24.25"	8.25"	24.1875"	24.25"
1235†	36" X 24" X 8"	1	34	24.25"	8.25"	24.25" X 36.25"	36.25"

* NEMA 3 rated

** UL listed with only a Type 1 NEMA rating

† Not UL listed

DUPLEX BOXES & COVER

SINGLE

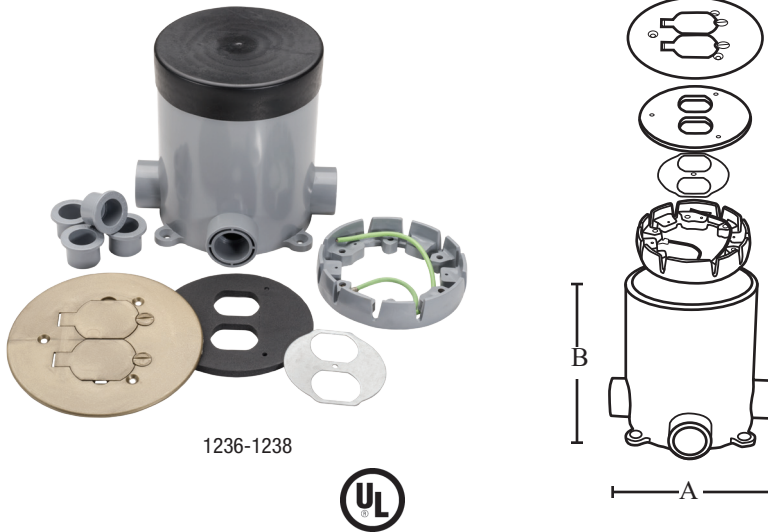

FEATURES

- Round, non-metallic PVC drop in box
- Bronze colored cover
- Includes reducers; corrosion resistant hardware

APPLICATIONS

- Non-multi-functional floor box can be used for power, data, or communications
- Easy trim out
- Accommodates concrete pours of different thickness

PART #	MASTER QTY.	WEIGHT/ CASE (LBS.)	A	B
1236	9	18	6.4375"	6"
Floor base box (4)-3/4" hubs, (4)-3/4"-1/2" reducers, level ring & pour cover				
1237	9	17	6.4375"	6"
Floor base box (2)-3/4" hubs, (2)-1" hubs (2)-3/4"-1/2" reducers, level ring & pour cover				
1238	10	3	---	---
PVC-Duplex cover bronze				

SWEDGED REDUCER



1480

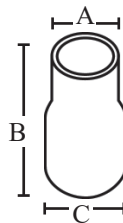

FEATURES

- Belled and spigot (plain) end
- Durable, corrosion resistant construction

APPLICATIONS

- Use to reduce diameter from one value to its next smaller conduit diameter
- Meets NEMA TC 3

STANDARD MATERIAL

- PVC

PART #	SIZE	MASTER QTY.	WEIGHT/ CASE (LBS.)	A	B	C
1480	2-1/2" X 2"	20	20	2.375	6.625	2.89
1481	3" X 2"	25	15	2.375	7.125	3.515
1482	3" X 2-1/2"	25	23	2.875	7.50	3.515
1483	4" X 3"	15	17	3.50	7.375	4.515
1484	5" X 4"	8	20	4.50	11.625	5.593
1485	6" X 5"	4	13	5.563	11.50	6.658

EXPANSION JOINT

METER RISER



1486

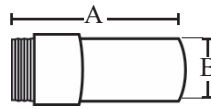

FEATURES

- Slip fit
- Male and spigot (plain) end

APPLICATIONS

- Expansion joint allow for temperature related expansions and contractions avoiding system damage

STANDARD MATERIAL

- PVC

PART #	SIZE	MASTER QTY.	WEIGHT/ CASE (LBS.)	A	B
1486	2"	16	31	26.625"	2.375"
1487	2-1/2"	12	51	23.6875"	3.375"
1488	3"	12	46	24"	4"
1490	4"	10	60	25"	5.125"

SEALING WASHER



1372



FEATURES

- High tensile and impact strength
- Industrial grade

APPLICATIONS

- Use with terminal adapters for concrete tight connection

STANDARD MATERIAL

- PVC

PART #	SIZE	MASTER QTY.	WEIGHT/ CASE (LBS.)
1371	1/2"	150	2
1372	3/4"	125	2
1373	1"	100	2
1374	1-1/4"	50	2
1375	1-1/2"	25	2
1376	2"	50	2

INTERMEDIATE SPACERS



1331

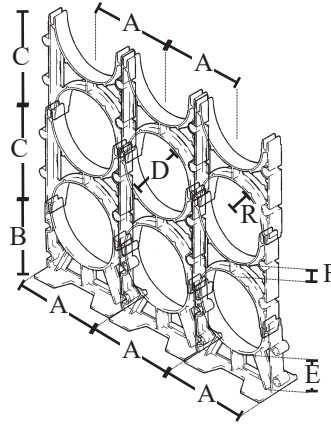

FEATURES

- Resistant to extreme temperature fluctuations
- Available in 16 sizes
- Snap lock design for fast field assembly
- Stays firmly in place during fill
- Heavy duty strut evenly distributes load

APPLICATIONS

- Support duct arrays within trenching before encasement
- For use with Topaz Base Spacer

STANDARD MATERIAL

- High impact polymers

PART #	SPACER SIZE	MASTER QTY.	WEIGHT/CASE (LBS.)	A	B	C	D	E	F	R
1331	4 X 1"	200	46	5.63"	4.06"	5.63"	4.63"	3"	1"	2.315"
1332	2 X 1-1/2"	500	50	3.975"	4.25"	3.985"	2.50"	3"	1.50"	1.25"
1333	3 X 1-1/2"	250	35	5.13"	4.81"	5.13"	3.63"	3"	1.50"	1.815"
1334	4 X 1-1/2"	180	49	6.13"	5.315"	6.13"	4.63"	1.75"	1.50"	2.315"
1335	5 X 1-1/2"	140	35	7.325"	5.90"	7.325"	5.69"	3"	1.50"	2.845"
1336	6 X 1-1/2"	100	28	8.23"	6.375"	8.25"	6.75"	3"	1.50"	3.375"
1337	2 X 2"	325	36	4.46"	4.25"	4.46"	2.50"	3"	1.50"	1.25"
1338	3 X 2"	225	35	5.63"	4.81"	5.63"	3.63"	3"	2"	1.815"
1339	4 X 2"	160	37	6.61"	5.315"	6.63"	4.63"	3"	2"	2.315"
1340	5 X 2"	100	36	7.833"	5.90"	7.83"	5.69"	3"	2"	2.845"
1341	6 X 2"	100	31	8.73"	6.375"	8.73"	6.75"	3"	2"	3.375"
1342	2 X 3"	275	39	5.465"	4.255"	5.46"	2.50"	3"	3"	1.25"
1343	3 X 3"	160	30	6.63"	4.81"	6.63"	3.63"	3"	3"	1.815"
1344	4 X 3"	125	33	7.61"	5.315"	7.625"	4.63"	3"	3"	2.315"
1345	5 X 3"	90	28	8.69"	5.90"	8.69"	5.69"	3"	3"	2.845"
1346	6 X 3"	75	26	9.79"	6.375"	9.75"	6.75"	3"	3"	3.375"

BASE SPACERS



1347

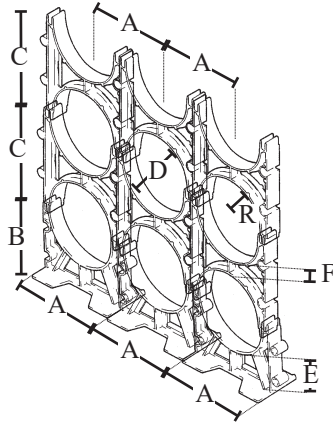

FEATURES

- Proven base plate design maintains consistent vertical separation between trench floor and first duct tier
- Two-piece interlock design eliminates banding
- Resistant to extreme temperature fluctuations
- Available in 16 sizes
- Snap lock design for fast field assembly
- Stays firmly in place during fill
- Heavy duty strut evenly distributes load

APPLICATIONS

- Support duct arrays within trenching before encasement
- For use with Topaz Intermediate Spacers

STANDARD MATERIAL

- High impact polymers

PART #	SPACER SIZE	MASTER QTY.	WEIGHT/CASE (LBS.)	A	B	C	D	E	F	R
1347	4 X 1"	250	50	5.63"	4.06"	5.63"	4.63"	3"	1"	2.315"
1348	2 X 1-1/2"	450	65	3.975"	4.25"	3.985"	2.50"	3"	1.50"	1.25"
1349	3 X 1-1/2"	250	48	5.13"	4.81"	5.13"	3.63"	3"	1.50"	1.815"
1350	4 X 1-1/2"	180	47	6.13"	5.315"	6.13"	4.63"	1.75"	1.50"	2.315"
1351	5 X 1-1/2"	140	43	7.325"	5.90"	7.325"	5.69"	3"	1.50"	2.845"
1352	6 X 1-1/2"	100	33	8.23"	6.375"	8.25"	6.75"	3"	1.50"	3.375"
1353	2 X 2"	325	48	4.46"	4.25"	4.46"	2.50"	3"	1.50"	1.25"
1354	3 X 2"	225	44	5.63"	4.81"	5.63"	3.63"	3"	2"	1.815"
1355	4 X 2"	180	47	6.61"	5.315"	6.63"	4.63"	3"	2"	2.315"
1356	5 X 2"	100	32	7.833"	5.90"	7.83"	5.69"	3"	2"	2.845"
1357	6 X 2"	100	34	8.73"	6.375"	8.73"	6.75"	3"	2"	3.375"
1358	2 X 3"	300	48	5.465"	4.255"	5.46"	2.50"	3"	3"	1.25"
1359	3 X 3"	190	41	6.63"	4.81"	6.63"	3.63"	3"	3"	1.815"
1360	4 X 3"	150	43	7.61"	5.315"	7.625"	4.63"	3"	3"	2.315"
1361	5 X 3"	90	30	8.69"	5.90"	8.69"	5.69"	3"	3"	2.845"
1362	6 X 3"	90	32	9.79"	6.375"	9.75"	6.75"	3"	3"	3.375"

ENT COUPLINGS



1491

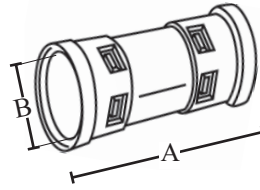

PART #	SIZE	MASTER QTY.	WEIGHT/ CASE (LBS.)	A	B
1491	1/2"	200	6	1.40"	.86"
1492	3/4"	200	9	2.035"	1.06"
1493	1"	100	6	2.35"	1.33"
1494	1-1/4"	30	4	2.93"	1.69"
1495	1-1/2"	30	3	2.495"	1.93"
1496	2"	20	5	2.35"	2.41"

FEATURES

- Snap in
- Impact resistant
- Concrete tight, requiring no solvent welding or tape around the connections
- Rated for 175 lbs pull out resistance
- Approved for use in noncombustible 2 hour and 4 hour fire-rated floor/ceiling assemblies
- Meets all UL and CSA requirements

APPLICATIONS

- For use with Topaz ENT Flexible Conduit in residential, commercial or institutional applications

STANDARD MATERIAL

- Impact resistant PVC

ENT STUBBY



1632

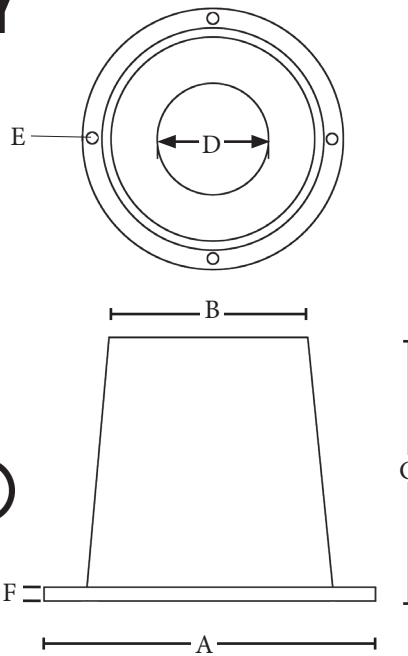

PART #	SIZE	MASTER QTY.	WEIGHT/ CASE (LBS.)	A	B	C	D	E	F
1631	1/2"	150	4	2.48"	1.45"	1.60"	.84"	.12"	.08"
1632	3/4"	150	7	2.48"	1.45"	1.60"	1.05"	.12"	.08"
1633	1"	200	14	3.64"	2.15"	1.60"	1.32"	.12"	.08"

FEATURES

- Threaded
- Impact resistant
- Concrete tight, requiring no solvent welding or tape around the connections
- Rated for 175 lbs pull out resistance
- Approved for use in noncombustible 2 hour and 4 hour fire-rated floor/ceiling assemblies
- Meets all UL and CSA requirements

APPLICATIONS

- For use with Topaz ENT Flexible Conduit in residential, commercial or institutional applications

STANDARD MATERIAL

- Impact resistant PVC

ENT TERMINAL ADAPTERS

THREADED



1511

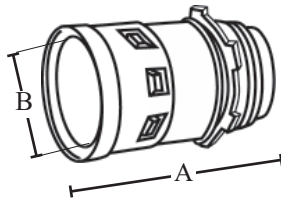

PART #	SIZE	MASTER QTY.	WEIGHT/ CASE (LBS.)	A	B
1511	1/2"	200	6	1.045"	.86"
1512	3/4"	200	9	1.105"	1.06"
1513	1"	100	7	1.22"	1.33"
2514	1-1/4"	30	3	2.19"	1.69"
2515	1-1/2"	30	4	1.96"	1.93"
2516	2"	20	5	1.89"	2.40"

FEATURES

- Threaded male end
- Concrete-tight, requiring no solvent welding or tape around the connections
- Unique six locking tab design has a pull-out resistance of up to 175 lbs
- Approved for noncombustible 2 hr. & 4 hr. fire-rated floor/ceiling assemblies
- Impact resistant; rust proof

APPLICATIONS

- Use to join tubing to ENT box or fitting
- For use with other ENT fittings that accept a male thread and locknut

STANDARD MATERIAL

- Impact resistant PVC

SNAP-IN



1611

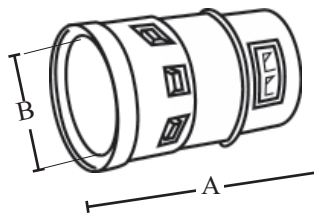

PART #	SIZE	MASTER QTY.	WEIGHT/ CASE (LBS.)	A	B
1611	1/2"	200	4	1.045"	.86"
1612	3/4"	200	6	1.105"	1.06"
1613	1"	100	5	1.22"	1.33"

FEATURES

- Double snap
- Concrete-tight, requiring no solvent welding or tape around the connections
- Unique six locking tab design has a pull-out resistance of up to 175 lbs
- Approved for noncombustible 2 hr. & 4 hr. fire-rated floor/ceiling assemblies
- Impact resistant; rust proof

APPLICATIONS

- For use with Topaz ENT Flexible Conduit in residential, commercial or institutional applications
- Male and female ends of coupling secure fitting to tubing

STANDARD MATERIAL

- Impact resistant PVC

ENT SLAB BOX WITH CONNECTORS

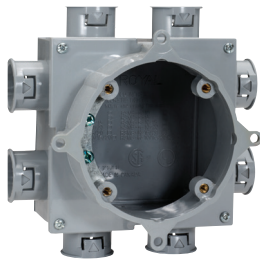

1636

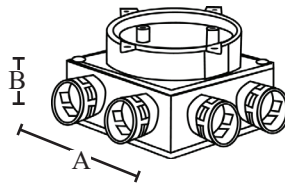

FEATURES

- Non-conductive, impact and corrosion resistant
- Concrete tight

APPLICATIONS

- Ideal for tough wall poured environments

STANDARD MATERIAL

- PVC

PART #	KNOCKOUTS	MASTER QTY.	WEIGHT/ CASE (LBS.)	A	B
1636	8 X 3/4"	25	16	4"	2.56"
1637	4 X 1/2" & 4 X 3/4"	25	18	4"	2.56"

CONDUIT CEMENT



1627

FEATURES

- Cold weather formula for faster setting
- Medium body, medium set clear cement
- Item number 1364 only, has cold weather formula for faster setting

APPLICATIONS

- For use on duct and conduit PVC pipe
- Secure, long lasting bonds
- Quick curing time

PART #	SIZE	MASTER QTY.	WEIGHT/ CASE (LBS.)
1327	1/2 PINT	24	15
1328	PINT	12	12
1329	QUART	12	27
1364	QUART - COLD WEATHER	12	27

PVC PRIMER/CLEANER



1628P

FEATURES

- Pint and quart sizes available
- Multi use primer and cleaner

APPLICATIONS

- Removes dirt, oils and other contaminants from the surface of PVC pipes to promote more secure solvent welds

PART #	SIZE	MASTER QTY.	WEIGHT/ CASE (LBS.)
1328P	PINT	12	12
1329P	QUART	12	23

ENT CONDUIT

COILS



1621



FEATURES

- Electrical Nonmetallic Tubing (ENT) coils
- UV rated
- Suitable for concrete encasement
- Pull resistant
- Fire resistant
- Impact resistant
- Flexible enough to be bent by hand, tough enough to withstand crushing and breaking

APPLICATIONS

- Can be installed and concealed in floors, walls and ceilings
- May be installed and exposed in areas not subject to physical damage and where the building does not exceed three floors above grade

STANDARD MATERIAL

- Heavy duty impact resistant PVC

PART #	SIZE	FEET PER COIL	FEET PER PACK	WEIGHT/ CASE (LBS.)	INNER DIAMETER	OUTER DIAMETER
1621	1/2"	200	400	19	.578"	.84"
1622	3/4"	100	200	13	.778"	1.05"
1623	1"	100	100	17	1"	1.315"

REELS

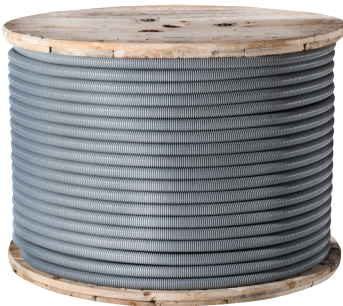

1622R



FEATURES

- Electrical Nonmetallic Tubing (ENT) reels
- UV rated
- Suitable for concrete encasement
- Pull resistant
- Fire resistant
- Impact resistant
- Flexible enough to be bent by hand, tough enough to withstand crushing and breaking

APPLICATIONS

- Can be installed and concealed in floors, walls, and ceilings
- May be installed and exposed in areas not subject to physical damage and where the building does not exceed three floors above grade

STANDARD MATERIAL

- Heavy duty impact resistant PVC

PART #	SIZE	FEET PER REEL	FEET PER PACK	WEIGHT/ CASE (LBS.)	INNER DIAMETER	OUTER DIAMETER
1621R	1/2"	1500	1500	187	.578"	.84"
1622R	3/4"	1000	1000	167	.778"	1.05"
1623R	1"	750	750	158	1"	1.315"
1624R	1 1/4"	1000	1000	254	1.345"	1.66"
1625R	1 1/2"	750	750	252	1.574"	1.90"
1626R	2"	500	500	240	2.025"	2.375"

PVC RIGID SPECIAL RADIUS ELBOWS

SCHEDULE 40 PVC



FEATURES

- Cleanly finished with plain spigot (plain) ends
- High tensile and impact strength

APPLICATIONS

- Enable connections between straight lengths of pipe; sizes available to accommodate almost any design configuration change

STANDARD MATERIAL

- Schedule 40 PVC

PART #	SIZE	MASTER QTY.	WEIGHT/ CASE (LBS.)
1377	1" x 90° x 18"	1	1
1378	1" x 90° x 24"	1	1
1379	1" x 90° x 36"	1	1
1380	1" x 90° x 48"	1	2
1381	1" x 45° x 18"	1	1
1382	1" x 45° x 24"	1	1
1383	1" x 45° x 36"	1	1
1384	1" x 45° x 48"	1	1
1385	1" x 30° x 18"	1	1
1386	1" x 30° x 24"	1	1
1387	1" x 30° x 36"	1	1
1388	1" x 30° x 48"	1	2
1389	1-1/4" x 90° x 18"	1	1
1390	1-1/4" x 90° x 24"	1	1
1391	1-1/4" x 90° x 36"	1	1
1392	1-1/4" x 90° x 48"	1	1
1393	1-1/4" x 45° x 18"	1	1
1394	1-1/4" x 45° x 24"	1	1
1395	1-1/4" x 45° x 36"	1	1
1396	1-1/4" x 45° x 48"	1	1
1397	1-1/4" x 30° x 18"	1	1
1398	1-1/4" x 30° x 24"	1	2
1399	1-1/4" x 30° x 36"	1	2
1400	1-1/4" x 30° x 48"	1	2
1402	1-1/2" x 90° x 24"	1	3
1403	1-1/2" x 90° x 36"	1	3
1404	1-1/2" x 90° x 48"	1	3
1405	1-1/2" x 45° x 18"	1	3
1406	1-1/2" x 45° x 24"	1	3
1407	1-1/2" x 45° x 36"	1	3
1408	1-1/2" x 45° x 48"	1	3
1409	1-1/2" x 30° x 18"	1	3
1410	1-1/2" x 30° x 24"	1	3
1411	1-1/2" x 30° x 36"	1	3
1412	1-1/2" x 30° x 48"	1	3

PART #	SIZE	MASTER QTY.	WEIGHT/ CASE (LBS.)
1413	2" x 90° x 18"	1	1
1414	2" x 90° x 24"	1	1
1415	2" x 90° x 36"	1	2
1416	2" x 90° x 48"	1	2
1417	2" x 45° x 18"	1	2
1418	2" x 45° x 24"	1	2
1419	2" x 45° x 36"	1	2
1420	2" x 45° x 48"	1	2
1421	2" x 30° x 18"	1	2
1422	2" x 30° x 24"	1	2
1423	2" x 30° x 36"	1	3
1424	2" x 30° x 48"	1	3
1425	2-1/2" x 90° x 18"	1	4
1426	2-1/2" x 90° x 24"	1	4
1427	2-1/2" x 90° x 36"	1	5
1428	2-1/2" x 90° x 48"	1	5
1429	2-1/2" x 45° x 18"	1	7
1430	2-1/2" x 45° x 24"	1	1
1431	2-1/2" x 45° x 36"	1	2
1432	2-1/2" x 45° x 48"	1	2
1433	2-1/2" x 30° x 18"	1	2
1434	2-1/2" x 30° x 24"	1	1
1435	2-1/2" x 30° x 36"	1	3
1436	2-1/2" x 30° x 48"	1	1
1437	3" x 90° x 18"	1	2
1438	3" x 90° x 24"	1	1
1439	3" x 90° x 36"	1	2
1440	3" x 90° x 48"	1	2
1441	3" x 45° x 18"	1	4
1442	3" x 45° x 24"	1	5
1443	3" x 45° x 36"	1	6
1444	3" x 45° x 48"	1	7
1445	3" x 30° x 18"	1	8
1446	3" x 30° x 24"	1	8
1447	3" x 30° x 36"	1	9
1448	3" x 30° x 48"	1	9

PVC - FITTINGS AND ELBOWS

PVC RIGID SPECIAL RADIUS ELBOWS

SCHEDULE 40 PVC CONTINUED



1449



PART #	SIZE	MASTER QTY.	WEIGHT/CASE (LBS.)
1449	3-1/2" x 90° x 24"	1	4
1450	3-1/2" x 90° x 36"	1	4
1451	3-1/2" x 90° x 48"	1	2
1452	3-1/2" x 45° x 24"	1	5
1453	3-1/2" x 45° x 36"	1	3
1454	3-1/2" x 45° x 48"	1	4
1455	3-1/2" x 30° x 24"	1	5
1456	3-1/2" x 30° x 36"	1	6
1457	3-1/2" x 30° x 48"	1	8
1458	4" x 90° x 24"	1	9
1459	4" x 90° x 36"	1	12
1460	4" x 90° x 48"	1	11
1461	4" x 45° x 24"	1	15
1462	4 x 45 x 36	1	3
1463	4" x 45° x 48"	1	4
1464	4" x 30° x 24"	1	5
1465	4" x 30° x 36"	1	7
1466	4" x 30° x 48"	1	3
1467	5" x 90° x 36"	1	3
1468	5" x 90° x 48"	1	4
1469	5" x 45° x 36"	1	4
1470	5" x 45° x 48"	1	7
1471	5" x 30° x 36"	1	11
1472	5" x 30° x 48"	1	11
1473	6" x 90° x 36"	1	5
1474	6" x 90° x 48"	1	5
1475	6" x 45° x 36"	1	5
1476	6" x 45° x 48"	1	6
1477	6" x 30° x 36"	1	6
1478	6" x 30° x 48"	1	6

FEATURES

- Cleanly finished with plain spigot (plain) ends
- High tensile and impact strength

APPLICATIONS

- Enable connections between straight lengths of pipe; sizes available to accommodate almost any design configuration change

STANDARD MATERIAL

- Schedule 40 PVC

45° PLAIN END ELBOWS

SCHEDULE 80 PVC



105180

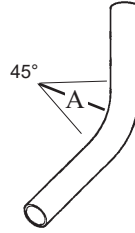

PART #	SIZE	MASTER QTY.	WEIGHT/ CASE (LBS.)	A MIN. RADIUS
105180	1/2"	50	7	4"
105280	3/4"	25	5	4.50"
105380	1"	25	9	5.75"
105480	1-1/4"	25	13	7.25"
105580	1-1/2"	25	18	8.25"
105680	2"	10	10	9.50"
105780	2-1/2"	20	39	10.50"
105880	3"	8	25	13"
106080	4"	20	115	16"
1060A80	5"	1	13	24"
1060B80	6"	1	16	30"

FEATURES

- Longer radius than "standard" UL elbows
- Both ends of the bend are spigot (plain) end
- Both ends are solvent weld

APPLICATIONS

- For indoor and outdoor use
- Can be used above ground or buried; suitable for concrete encasement

STANDARD MATERIAL

- Schedule 80 PVC

90° PLAIN END ELBOWS

SCHEDULE 80 PVC



104180

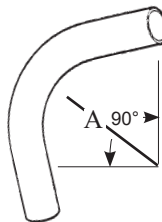

PART #	SIZE	MASTER QTY.	WEIGHT/ CASE (LBS.)	A MIN. RADIUS
104180	1/2"	50	9	4"
104280	3/4"	35	9	4.50"
104380	1"	20	12	5.75"
104480	1-1/4"	30	24	7.25"
104580	1-1/2"	1	28	8.25"
104680	2"	15	26	9.50"
104780	2-1/2"	18	57	10.50"
104880	3"	10	68	13"
105080	4"	10	92	16"
1050A80	5"	1	9	24"
1050B80	6"	1	11	30"

FEATURES

- Longer radius than "standard" UL elbows
- Both ends of the bend are spigot (plain) end
- Both ends are solvent weld

APPLICATIONS

- For indoor and outdoor use
- Can be used above ground or buried; suitable for concrete encasement

STANDARD MATERIAL

- Schedule 80 PVC

PVC SPECIAL RADIUS ELBOWS

SCHEDULE 80 PVC



141480



FEATURES

- High tensile and impact strength
- Resistant to damage from moisture and corrosive materials
- Industrial strength; superior weather resistant characteristics help rebuff elemental damage

APPLICATIONS

- For indoor, outdoor, above ground and direct burial applications

STANDARD MATERIAL

- Schedule 80 PVC

PART #	SIZE	MASTER QTY.	WEIGHT/ CASE (LBS.)
141480	2" X 90° X 24"	1	2
141580	2" X 90° X 36"	1	2
141680	2" X 90° X 48"	1	2
143980	3" X 90° X 36"	1	4
144080	3" X 90° X 48"	1	4
145980	4" X 90° X 36"	1	6
146080	4" X 90° X 48"	1	7
146780	5 X 90° X 36"	1	7
146880	5" X 90° X 48"	1	7
147380	6 X 90° X 36"	1	9

PVC - SCHEDULE 80



Southwire™

PVC FITTINGS & ELBOWS CATALOG

GET SOCIAL WITH US:



**/SOUTHWIRETOOLS
/SOUTHWIRETOOLSLATINO**



@SOUTHWIRETOOLS



@SOUTHWIRETOOLS



SOUTHWIRETOOLS

SOUTHWIRE.COM | 1-855-SWTOOLS

All Trademarks or Registered Trademarks (TM/®) are owned or licensed by Southwire Company.
Any other TM/® - Trademark or Registered Trademark of Southwire Company.