



Southwire™

HANGING & SUPPORT CATALOG



**BUILT FOR DURABILITY.
BUILT FOR RELIABILITY.
BUILT FOR WORK.™**

SOUTHWIRE.COM

HANGING & SUPPORT

PRODUCTS FOR EVERY APPLICATION

Southwire™ is pleased to offer a comprehensive line of Hanging and Support, including over 300 Spring Steel items, manufactured to our standards of superior quality.

Our assortment offers versatile solutions in a variety of sizes used at the stud level of construction to hang, support or mount anything from wire and cable, conduit to rods, to strut, and steel boxes.

Spring Steel Fasteners & Supports create time savings and efficiency on the job site, empowering electricians to demonstrate skill and quality of work through a display of neatly organized cables and wire.

ABOUT SOUTHWIRE™ GEOSEAL™

The Southwire™ GEOSEAL™ anti-corrosion coating is a high-performance, water-based and chrome-free, zinc and aluminum flake technology that protects our Spring Steel Fasteners & Supports from corrosion. Free of toxic metals such as chromium, nickel, cadmium, lead, barium and mercury, the metallic silver coating is odorless and contractor friendly. The GEOSEAL™ coating is salt spray-tested over hundreds of hours to ensure excellent adhesion as well as damage and chemical resistance.

CABLE/ CONDUIT

**Secures cable and conduit to
electrical support systems**

BEAM ATTACHMENT

ROD/WIRE HANGERS

STRUT CLAMPS

CLAMPS AND CLIPS

BRACKETS AND HANGERS

COMBINATION BOX/CONDUIT

PIPE FITTINGS

BEAM ATTACHMENT



CABLE TO FLANGE CLIP



RMX58TZ

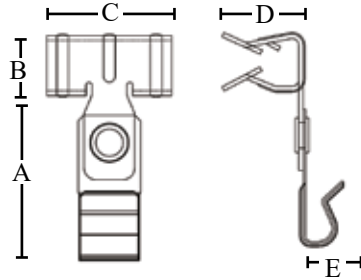

FEATURES

- Supports 14-2 to 12-2 MC/AC cables
- Accommodates flange thickness of 5/16" - 1/2"
- Hammer-on installation

APPLICATION

- Supports Nonmetallic sheathed cable to flanges

MATERIAL/FINISH

- Spring Steel/GEOSEAL™

CERTIFICATIONS

- UL Standard: UL 2239



| PART # | BOX QTY. | A | B | C | D | E |
|---------|----------|-------|-------|-------|-------|-------|
| RMX58TZ | 100 | 1.44" | .606" | 1.26" | .866" | .331" |

CABLE CLIPS



SC2DTZ

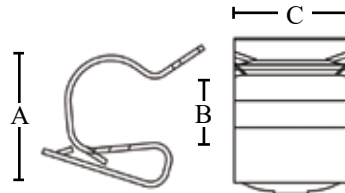

FEATURES

- Easy hammer-on installation
- Supports cables to beams with no additional hardware

APPLICATION

- Cable clips easily snap on to flanges for cable positioning, no load rating listed

MATERIAL/FINISH

- Spring Steel/GEOSEAL™

CERTIFICATIONS

- UL Standard: UL 2239



| PART # | FLANGE THICKNESS | CABLE DIAMETER | BOX QTY. | A | B | C |
|--------|------------------|----------------|----------|-------|-------|-------|
| SC2DTZ | 1/16" - 3/16" | .472" - .551" | 100 | .744" | .343" | .551" |
| SC2FTZ | 1/16" - 3/16" | .748" - .945" | 100 | 1.02" | .356" | .551" |
| SC4DTZ | 3/16" - 9/32" | .472" - .551" | 100 | .744" | .343" | .551" |
| SC4ETZ | 3/16" - 9/32" | .591" - .709" | 100 | .645" | .335" | .551" |

No load rating, for positioning only

SNAP-CLOSE CONDUIT TO FLANGE CLAMP

BOTTOM MOUNT



812M24TZ



812M58TZ



812M912TZ

FEATURES

- Hammer-on installation
- Snap-close conduit clip pivots 360°
- Secures EMT, rigid and aluminum conduit to beams

APPLICATION

- Conduit flange mount snap-close clamps support EMT and rigid conduit from beams.
- Equipped with a rotatable joint allows the snap-close conduit clip to rotate 360° to position conduit in different directions

MATERIAL/FINISH

- Spring Steel/GEOSEAL™

CERTIFICATIONS

- UL Standard: UL 2239

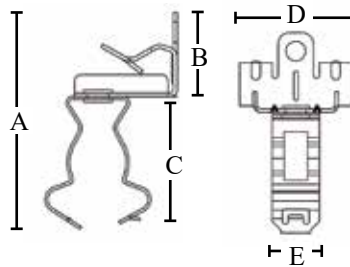

| PART # | FLANGE THICKNESS | STATIC LOAD (LBS.) | EMT/RIGID SIZE | FMC SIZE | MC/AC SIZE | BOX QTY. | A | B | C | D | E |
|------------|------------------|--------------------|----------------|----------|-------------|----------|-------|-------|-------|-------|------|
| 6M24TZ | 1/8" – 1/4" | 75 | --- | 3/8" | 14-2 – 12-3 | 100 | 2.74" | 1.06" | 1.68" | 1.50" | .63" |
| 812M24TZ | 1/8" – 1/4" | 75 | 1/2" & 3/4" | --- | --- | 100 | 3.11" | 1.06" | 2.05" | 1.50" | .63" |
| 16M24TZ | 1/8" – 1/4" | 75 | 1" | --- | --- | 100 | 3.58" | 1.06" | 2.52" | 1.50" | .63" |
| 20M24TZ | 1/8" – 1/4" | 75 | 1-1/4" | --- | --- | 50 | 4.02" | 1.06" | 2.96" | 1.50" | .63" |
| BC18KC112 | 1/8" – 1/4" | 75 | 1-1/2" | --- | --- | 50 | 4.24" | 1.06" | 3.18" | 1.50" | .63" |
| 32M24TZ | 1/8" – 1/4" | 75 | 2" | --- | --- | 50 | 5.51" | 1.63" | 3.88" | 1.50" | .63" |
| 6M58TZ | 5/16" – 1/2" | 75 | --- | 3/8" | 14-2 – 12-3 | 100 | 2.97" | 1.29" | 1.68" | 1.50" | .63" |
| 812M58TZ | 5/16" – 1/2" | 75 | 1/2" & 3/4" | --- | --- | 100 | 3.34" | 1.29" | 2.05" | 1.50" | .63" |
| BC516KC1 | 5/16" – 1/2" | 75 | 1 | --- | --- | 50 | 3.58" | 1.29" | 2.52" | 1.50" | .63" |
| BC516KC114 | 5/16" – 1/2" | 75 | 1-1/4" | --- | --- | 50 | 4.02" | 1.29" | 2.96" | 1.50" | .63" |
| BC516KC112 | 5/16" – 1/2" | 75 | 1-1/2" | --- | --- | 50 | 4.47" | 1.29" | 3.18" | 1.50" | .63" |
| BC516KC2 | 5/16" – 1/2" | 75 | 2" | --- | --- | 50 | 5.51" | 1.63" | 3.88" | 1.50" | .63" |
| 6M912TZ | 9/16" – 3/4" | 75 | --- | 3/8" | 14-2 – 12-3 | 100 | 3.31" | 1.63" | 1.68" | 1.75" | .63" |
| 812M912TZ | 9/16" – 3/4" | 75 | 1/2" & 3/4" | --- | --- | 100 | 3.68" | 1.63" | 2.05" | 1.75" | .63" |
| 16M912TZ | 9/16" – 3/4" | 75 | 1" | --- | --- | 50 | 4.15" | 1.63" | 2.52" | 1.75" | .63" |

HANGING AND SUPPORT

SNAP-CLOSE CONDUIT TO FLANGE CLAMP

SIDE MOUNT



812M58SMTZ



24M58SMTZ

FEATURES

- Hammer-on installation
- Snap-close conduit clip pivots 360°
- Secures EMT, rigid and aluminum conduit to beams

APPLICATION

- Conduit flange mount snap-close clamps support EMT and rigid conduit from beams.
- Equipped with a rotatable joint allows the snap-close conduit clip to rotate 360° to position conduit in different directions

MATERIAL/FINISH

- Spring Steel/GEOSEAL™

CERTIFICATIONS

- UL Standard: UL 2239

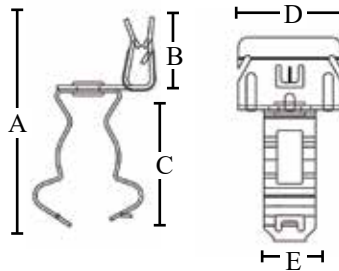

HANGING AND SUPPORT

| PART # | FLANGE THICKNESS | STATIC LOAD (LBS.) | EMT/RIGID SIZE | FMC SIZE | MC/AC SIZE | BOX QTY. | A | B | C | D | E |
|-------------|------------------|--------------------|----------------|----------|------------|----------|-------|-------|-------|-------|------|
| 6M24SMTZ | 1/8" – 1/4" | 25 | --- | 3/8" | 14-2, 12-3 | 100 | 2.56" | .886" | 1.68" | 1.26" | .63" |
| 16M24SMTZ | 1/8" – 1/4" | 25 | 1" | --- | --- | 100 | 3.41" | .886" | 2.52" | 1.26" | .63" |
| 20M24SMTZ | 1/8" – 1/4" | 25 | 1-1/4" | --- | --- | 100 | 3.85" | .886" | 2.96" | 1.26" | .63" |
| 24M24SMTZ | 1/8" – 1/4" | 25 | 1-1/2" | --- | --- | 50 | 4.07" | .886" | 3.18" | 1.26" | .63" |
| 32M24SMTZ | 1/8" – 1/4" | 25 | 2" | --- | --- | 50 | 4.77" | .886" | 3.88" | 1.26" | .63" |
| 812M24SMTZ | 1/8" – 1/4" | 25 | 1/2" & 3/4" | --- | --- | 100 | 2.94" | .886" | 2.05" | 1.26" | .63" |
| 16M58SMTZ | 5/16" – 1/2" | 25 | 1" | --- | --- | 100 | 3.41" | .886" | 2.52" | 1.26" | .630 |
| 20M58SMTZ | 5/16" – 1/2" | 25 | 1-1/4" | --- | --- | 100 | 3.83" | .886" | 2.96" | 1.26" | .63" |
| 24M58SMTZ | 5/16" – 1/2" | 25 | 1-1/2" | --- | --- | 50 | 4.07" | .886" | 3.18" | 1.26" | .63" |
| 32M58SMTZ | 5/16" – 1/2" | 25 | 2" | --- | --- | 50 | 4.77" | .886" | 3.88" | 1.26" | .63" |
| 812M58SMTZ | 5/16" – 1/2" | 25 | 1/2" & 3/4" | --- | --- | 100 | 2.92" | .886" | 2.05" | 1.26" | .63" |
| 6M912SMTZ | 9/16" – 3/4" | 25 | --- | 3/8" | 14-2, 12-3 | 100 | 2.56" | .886" | 1.68" | 1.26" | .63" |
| 16M912SMTZ | 9/16" – 3/4" | 25 | 1" | --- | --- | 100 | 3.39" | .886" | 2.52" | 1.26" | .63" |
| 20M912SMTZ | 9/16" – 3/4" | 25 | 1-1/4" | --- | --- | 100 | 3.83" | .886" | 2.96" | 1.26" | .63" |
| 32M912SMTZ | 9/16" – 3/4" | 25 | 2" | --- | --- | 50 | 4.77" | .886" | 3.88" | 1.26" | .63" |
| 812M912SMTZ | 9/16" – 3/4" | 25 | 1/2" & 3/4" | --- | --- | 100 | 2.92" | .886" | 2.05" | 1.26" | .63" |

PUSH-CLOSE CONDUIT TO FLANGE CLIP

BOTTOM MOUNT



12P58TZ

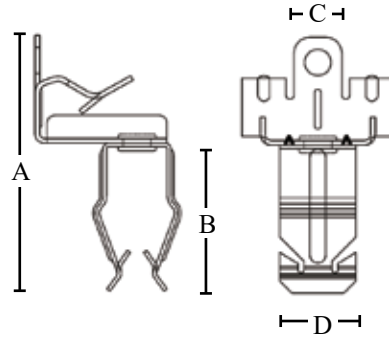

FEATURES

- Hammer-on installation
- Conduit clip pivots 360°
- Secures EMT, rigid and aluminum conduit to beams

APPLICATION

- Conduit flange mount clips support EMT and rigid conduit from beams.
- Equipped with a rotatable joint, the conduit clip rotates 360° to position conduit in different directions

MATERIAL/FINISH

- Spring Steel/GEOSEAL™

CERTIFICATIONS

- UL Standard: UL 2239



| PART # | FLANGE THICKNESS | EMT SIZE | RIGID SIZE | STATIC LOAD (LBS.) | BOX QTY. | A | B | C | D |
|----------|------------------|----------|------------|--------------------|----------|-------|-------|-------|-------|
| 8P24TZ | 1/8" – 1/4" | 1/2" | --- | 25 | 100 | 2.52" | 1.46" | 1.50" | .748" |
| 8P58TZ | 5/16" – 1/2" | 1/2" | --- | 25 | 100 | 2.75" | 1.46" | 1.50" | .748" |
| 8P912TZ | 9/16" – 3/4" | 1/2" | --- | 25 | 50 | 3.09" | 1.46" | 1.50" | .748" |
| 12P24TZ | 1/8" – 1/4" | 3/4" | 3/4" | 25 | 100 | 2.73" | 1.67" | 1.50" | .748" |
| 12P58TZ | 5/16" – 1/2" | 3/4" | 3/4" | 25 | 100 | 2.96" | 1.67" | 1.50" | .748" |
| 12P912TZ | 9/16" – 3/4" | 3/4" | 3/4" | 25 | 100 | 3.30" | 1.67" | 1.50" | .748" |
| 16P24TZ | 1/8" – 1/4" | 1" | 1" | 25 | 100 | 3.01" | 1.95" | 1.50" | .748" |
| 16P58TZ | 5/16" – 1/2" | 1" | 1" | 25 | 100 | 3.24" | 1.95" | 1.50" | .748" |
| 16P912TZ | 9/16" – 3/4" | 1" | 1" | 25 | 100 | 3.58" | 1.95" | 1.50" | .748" |

HANGING AND SUPPORT

PUSH-CLOSE CONDUIT TO FLANGE CLIP

SIDE MOUNT



8P24SMTZ

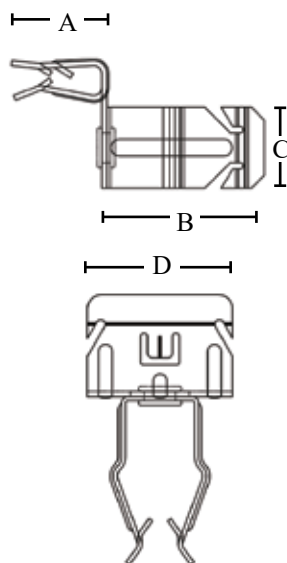

FEATURES

- Hammer-on installation
- Conduit clip pivots 360°
- Secures EMT, rigid and aluminum conduit to beams

APPLICATION

- Conduit flange mount clips support EMT and rigid conduit from beams.
- Equipped with a rotatable joint, the conduit clip rotates 360° to position conduit in different directions.

MATERIAL/FINISH

- Spring Steel/GEOSEAL™

CERTIFICATIONS

- UL Standard: UL 2239



| PART # | FLANGE THICKNESS | EMT SIZE | RIGID SIZE | STATIC LOAD (LBS.) | BOX QTY. | A | B | C | D |
|------------|------------------|----------|------------|--------------------|----------|-------|-------|-------|-------|
| 8P24SMTZ | 1/8" – 1/4" | 1/2" | --- | 15 | 100 | .886" | 1.46" | .748" | 1.26" |
| 8P58SMTZ | 5/16" – 1/2" | 1/2" | --- | 15 | 100 | .886" | 1.46" | .748" | 1.26" |
| 8P912SMTZ | 9/16" – 3/4" | 1/2" | --- | 15 | 100 | .886" | 1.46" | .748" | 1.26" |
| 12P24SMTZ | 1/8" – 1/4" | 3/4" | 1/2" | 15 | 100 | .886" | 1.67" | .748" | 1.26" |
| 12P58SMTZ | 5/16" – 1/2" | 3/4" | 1/2" | 15 | 100 | .886" | 1.67" | .748" | 1.26" |
| 12P912SMTZ | 9/16" – 3/4" | 3/4" | 1/2" | 15 | 100 | .886" | 1.67" | .748" | 1.26" |
| 16P24SMTZ | 1/8" – 1/4" | 1" | 3/4" | 15 | 100 | .886" | 2.37" | .63" | 1.26" |
| 16P58SMTZ | 5/16" – 1/2" | 1" | 3/4" | 15 | 100 | .886" | 2.37" | .63" | 1.26" |
| 16P912SMTZ | 9/16" – 3/4" | 1" | 3/4" | 15 | 100 | .886" | 2.37" | .63" | 1.26" |

CLAMPS & CLIPS



PUSH-IN CONDUIT CLIPS



12PTZ

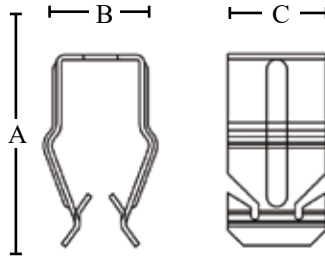

FEATURES

- Push-in attachment
- Vertical or horizontal mounting
- Combined with other Southwire fasteners to hang conduit to beams, purlins or rods

APPLICATION

- Conduit clips are mounted to structures to support EMT and rigid conduit
- Provides a convenient way to align conduit to electrical boxes

MATERIAL/FINISH

- Spring Steel/GEOSEAL™

CERTIFICATIONS

- UL Standard: UL 2239



| PART # | EMT SIZE | RIGID SIZE | HOLE SIZE | HOLE TYPE | LOAD CAPACITY (LBS.) | | A | B | C | BOX QTY. |
|--------|----------|------------|-----------|-----------|----------------------|------------|-------|-------|-------|----------|
| | | | | | VERTICAL | HORIZONTAL | | | | |
| 8PTZ | 1/2" | --- | 9/32" | PLAIN | 25 | 15 | 1.46" | .67" | .748" | 100 |
| 12PTZ | 3/4" | 1/2" | 9/32" | PLAIN | 25 | 15 | 1.67" | .709" | .748" | 100 |
| 16PTZ | 1" | 3/4" | 9/32" | PLAIN | 25 | 15 | 2.37" | .787" | .63" | 100 |

PUSH-IN CONDUIT HANGERS

BACK-TO-BACK FOR EMT



CHB-5075



FEATURES

- No tools are required for installation
- Simply snap in conduit and it is secured by sharp teeth that bite against the pipe's metallic surface

APPLICATION

- Back-to-back push-in conduit hangers allow the installer to support two conduit of the same or different sizes with the appropriate spacing required by code

MATERIAL/FINISH

- Spring Steel/Zinc plated

CERTIFICATIONS

- cULus listed

| PART # | (1) EMT SIZE | (2) EMT SIZE | LOAD CAPACITY (LBS.) | BOX QTY. |
|-----------|--------------|--------------|----------------------|----------|
| 8P8PTZ | 1/2" | 1/2" | 25 | 100 |
| CHB-5075 | 1/2" | 3/4" | 25 | 50 |
| CHB-50100 | 1/2" | 1" | 25 | 50 |
| CHB-75 | 3/4" | 3/4" | 25 | 50 |
| CHB-75100 | 3/4" | 1" | 25 | 50 |
| CHB-100 | 1" | 1" | 25 | 50 |

90° ANGLE BRACKET FOR EMT



CHPA-50

FEATURES

- Hanger provides a quick means of support for horizontal conduit runs of EMT, Rigid, MC/AC Cable through metal stud openings

APPLICATION

- Push-in conduit hangers are attached to an angle bracket that accommodates multiple mounting methods
- Hangers can be used with beam clamps or directly mounted to a variety of wood or metal surfaces when conduit need to be offset from walls

MATERIAL/FINISH

- Spring Steel/Zinc plated

| PART # | EMT SIZE | BOX QTY. |
|----------|----------|----------|
| CHPA-50 | 1/2" | 50 |
| CHPA-75 | 3/4" | 50 |
| CHPA-100 | 1" | 50 |

SNAP-CLOSE CONDUIT CLAMPS



6MTZ



16MTZ



20MTZ

FEATURES

- Snap close conduit attachment
- Vertical or horizontal mounting

APPLICATION

- Conduit clamps are mounted to structures to support EMT and rigid conduit
- Provides a convenient way to align conduit to electrical boxes

MATERIAL/FINISH

- Spring Steel/GEOSEAL™

CERTIFICATIONS

- UL Standard: UL 2239

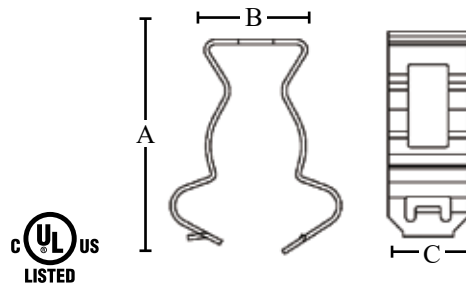

| PART # | HOLE TYPE | HOLE SIZE | FMC SIZE | MC/AC SIZE | EMT RIGID SIZE | LOAD CAPACITY (LBS.) | | BOX QTY. | A | B | C |
|----------|-----------|-----------|----------|-------------|----------------|----------------------|------------|----------|-------|-------|------|
| | | | | | | VERTICAL | HORIZONTAL | | | | |
| 6MTZ | PLAIN | 9/32" | 3/8" | 14-2 - 12-3 | --- | 100 | 25 | 100 | 1.68" | .807" | .63" |
| 16MTZ | PLAIN | 9/32" | --- | --- | 1" | 100 | 25 | 100 | 2.52" | .787" | .63" |
| 20MTZ | PLAIN | 9/32" | --- | --- | 1-1/4" | 100 | 25 | 100 | 2.96" | .807" | .63" |
| 24MTZ | PLAIN | 9/32" | --- | --- | 1-1/2" | 100 | 25 | 100 | 3.18" | .807" | .63" |
| 32MTZ | PLAIN | 9/32" | --- | --- | 2" | 100 | 25 | 100 | 3.88" | .807" | .63" |
| 812MTZ | PLAIN | 9/32" | --- | --- | 1/2" & 3/4" | 100 | 25 | 100 | 2.05" | .807" | .63" |
| 6M4ITZ | THREADED | 1/4" | 3/8" | 14-2 - 12-3 | --- | 100 | 25 | 100 | 1.68" | .807" | .630 |
| 16M4ITZ | THREADED | 1/4" | --- | --- | 1" | 100 | 25 | 100 | 2.52" | .787" | .63" |
| 20M4ITZ | THREADED | 1/4" | --- | --- | 1-1/4" | 100 | 25 | 100 | 2.96" | .807" | .63" |
| 24M4ITZ | THREADED | 1/4" | --- | --- | 1-1/2" | 100 | 25 | 100 | 3.18" | .807" | .63" |
| 32M4ITZ | THREADED | 1/4" | --- | --- | 2" | 100 | 25 | 100 | 3.88" | .807" | .63" |
| 812M4ITZ | THREADED | 1/4" | --- | --- | 1/2" & 3/4" | 100 | 25 | 100 | 2.05" | .807" | .63" |

CONDUIT TO CONDUIT CLAMP



16812MTZ

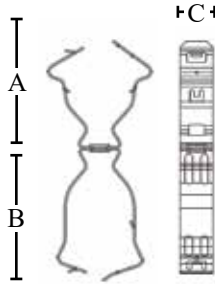

FEATURES

- Conduit quickly set in place and are secured by snapping the fastener closed to secure it in place
- Riveted assembly allows both conduit hangers to rotate to any position required

APPLICATION

- Snap-close conduit to conduit clamps support two conduit of different sizes running in parallel or perpendicular paths

MATERIAL/FINISH

- Spring Steel/GEOSEAL™

CERTIFICATIONS

- UL Standard: UL 2239

| PART # | (1) EMT SIZE | (2) EMT SIZE | LOAD CAPACITY (LBS.) | BOX QTY. | A | B | C |
|------------|--------------|--------------|----------------------|----------|-------|-------|-------|
| 16812MTZ | 1/2" or 3/4" | 1" | 100 | 100 | 1.92" | 2.39" | .629" |
| KCB-100100 | 1" | 1" | 100 | 50 | 2.29" | 2.39" | .629" |
| KCB-100125 | 1" | 1-1/4" | 100 | 50 | 2.39" | 2.96" | .629" |

Total load must not exceed 100 lbs.

THROUGH STUD CABLE/CONDUIT CLAMP



BAKC38

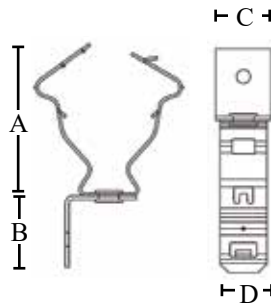

FEATURES

- Hanger provides a quick means of support for horizontal conduit runs of EMT, Rigid, MC/AC Cable through metal stud openings
- Supports 1/2", 3/4" EMT, 3/4" Rigid
- Reduces conduit rattling
- Screws to metal or wood studs

APPLICATION

- Snap-in conduit hangers are attached to an angle bracket that accommodates multiple mounting methods
- Hangers can be used with beam clamps or directly mounted to a variety of wood or metal surfaces when conduit need to be offset from walls

MATERIAL/FINISH

- Spring Steel/Black finish

CERTIFICATIONS

- UL or cULus

| PART # | EMT SIZE | BOX QTY. | A | B | C | D |
|------------|--------------|----------|-------|-------|-------|------|
| BAKC38* | 3/8" | 100 | 1.68" | .957" | .748" | .63" |
| FB812MTZ** | 1/2" or 3/4" | 100 | 2.05" | .957" | .748" | .63" |

*UL | **cULus

CONDUIT HANGERS WITH BOLT



CD0BTZ

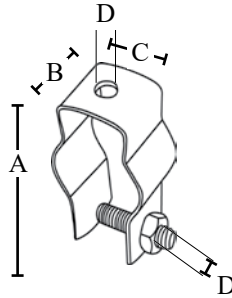

FEATURES

- Assembled with nut and bolt
- Use in areas where EMT or rigid conduit are used

APPLICATION

- Indoor or outdoor, use to secure and suspend conduit from overhead supports

MATERIAL/FINISH

- Steel/Zinc plated

CERTIFICATIONS

- UL Standard: UL2239



| PART # | RIGID SIZE | EMT SIZE | BOLT SIZE | BOX QTY. | A | B | C | D |
|----------|------------|----------|------------|----------|--------|-------|--------|--------|
| CD0BTZ | 1/2" | 1/2" | 1/4" - 20 | 100 | 1.875" | .75" | .725" | .25" |
| CD1BTZ | 3/4" | 3/4" | 1/4" - 20 | 100 | 2.125" | .75" | .85" | .25" |
| CD2BTZ | 1" | 1" | 1/4" - 20 | 100 | 2.437" | .875" | .975" | .25" |
| CD2.5BTZ | --- | 1-1/4" | 1/4" - 20 | 100 | 2.875" | .875" | .975" | .25" |
| CD4BTZ | 1-1/2" | --- | 1/4" - 20 | 100 | 3.125" | 1" | 1.125" | .25" |
| CD5BTZ | 2" | 2" | 1/4" - 20 | 50 | 3.875" | 1" | 1.145" | .25" |
| CD6BTZ | 2-1/2" | 2-1/2" | 5/16" - 18 | 50 | 4.625" | 1.25" | 1.225" | .3125" |
| CD7BTZ | 3" | 3" | 5/16" - 18 | 25 | 5.50" | 1.25" | 1.275" | .3125" |
| CD8BTZ | 3-1/2" | 3-1/2" | 5/16" - 18 | 25 | 5.75" | 1.25" | 1.275" | .3125" |
| CD9BTZ | 4" | 4" | 5/16" - 18 | 25 | 6.25" | 1.25" | 1.275" | .3125" |

HANGING AND SUPPORT

| TRADE SIZE | METRIC DESIGNATOR | PULL FORCE (LOAD RATING) | | | | | |
|------------|-------------------|--------------------------|----------------------------|------------------|----------------------------|-------------------|----------------------------|
| | | (EMT) | | (RMC) (IMC) | | RIGID PVC CONDUIT | |
| | | PULL FORCE (LBF) | REFERENCE LOAD RATING (LB) | PULL FORCE (LBF) | REFERENCE LOAD RATING (LB) | PULL FORCE (LBF) | REFERENCE LOAD RATING (LB) |
| 1/2" | (16) | 150 | 50 | 150 | 50 | 150 | 50 |
| 3/4" | (21) | 150 | 50 | 150 | 50 | 150 | 50 |
| 1" | (27) | 190 | 60 | 190 | 60 | 160 | 50 |
| 1-1/4" | (35) | 225 | 75 | 225 | 75 | 175 | 55 |
| 1-1/2" | (41) | 250 | 80 | 250 | 80 | 180 | 60 |
| 2" | (53) | 300 | 100 | 300 | 100 | 200 | 65 |
| 2-1/2" | (63) | 375 | 125 | 375 475 | 125 160 | 250 | 80 |
| 3" | (78) | 500 | 160 | 500 875 | 165 295 | 300 | 100 |
| 3-1/2" | (91) | 600 | 200 | 600 1125 | 200 375 | 375 | 125 |
| 4" | (103) | 700 | 230 | 700 | 230 | 450 | 150 |

CONDUIT HANGERS FOR EMT OR RIGID/IMC

SELF THREADING WITH BOLT (NO NUT)



SW0-WBA



FEATURES

- 3/8" - 2" self threading (no nut required)

APPLICATION

- Secures EMT or Rigid/IMC conduit to threaded rod, insulated supports, or mounting surface

MATERIAL/FINISH

- Steel/Zinc plated

CERTIFICATIONS

- cULus Listed

| PART # | EMT SIZE | RIGID SIZE | BOX QTY. |
|-----------|----------|------------|----------|
| SW0-WBA | 1/2" | 3/8" | 100 |
| 1-WBA | 3/4" | 3/4" | 100 |
| 2-WBA | 1" | 1" | 100 |
| 2-1/2-WBA | 1-1/4" | --- | 100 |
| 3-WBA | 1-1/2" | 1-1/4" | 100 |
| 4-WBA | --- | 1-1/2" | 100 |
| 5-WBA | 2" | 2" | 50 |

CONDUIT HANGERS FOR EMT OR RIGID/IMC AND SWING BOLT



CHQ-50



SNAP ON CONDUIT,
SWING IN BOLT

FEATURES

- Swing in bolt feature saves installation time

APPLICATION

- Secures EMT or Rigid/IMC conduit to threaded rod, insulated supports, or mounting surface

MATERIAL/FINISH

- Steel/Zinc plated

| PART # | EMT SIZE | RIGID SIZE | BOX QTY. |
|--------|----------|------------|----------|
| CHQ-50 | 1/2" | 3/8" | 50 |
| CHQ-75 | 3/4" | 3/4" | 25 |

HANGING AND SUPPORT

CONDUIT HANGERS, WITH BOLT & NUT

STEEL



SW0-WBAS



CHSS-50

FEATURES

- Corrosion-resistant material is ideal for corrosive environments

APPLICATION

- Secures EMT or Rigid/IMC conduit to threaded rod, insulated supports, or mounting surface

MATERIAL/FINISH

- 301 and 316 Stainless steel

| PART # | MATERIAL | EMT SIZE | RIGID SIZE | BOX QTY. |
|------------|------------------------|------------------------|--------------|----------|
| CHSS-50 | 316 STAINLESS STEEL | 1/2" | 3/8" OR 1/2" | 50 |
| CHSS-75 | | 3/4" | 1/2" OR 3/4" | 25 |
| CHSS-100 | | 1" | 3/4" | 25 |
| CHSS-125 | | 1-1/4" | 1" | 25 |
| CHSS-150 | | 1-1/2" | 1-1/4" | 25 |
| CHSS-175 | | | 1-1/2" | 20 |
| CHSS-200 | | 2" | --- | 10 |
| CHSS-250 | | 2-1/2" | 2-1/2" | 10 |
| CHSS-300 | | 3" | 3" | 10 |
| CHSS-350 | | 3-1/2" | 3-1/2" | 10 |
| CHSS-400 | | 4" | 4" | 10 |
| SW0-WBAS | | 301 STAINLESS STEEL | 1/2" | 3/8" |
| 1-WBAS | 3/4" | | 3/4" | 100 |
| 2-WBAS | 1" | | 1" | 100 |
| 2-1/2-WBAS | 1-1/4" | | --- | 100 |
| 3-WBAS | 1-1/2" | | 1-1/4" | 100 |
| 4-WBAS | | | 1-1/2" | 100 |
| 5-WBAS | 2" | | 2" | 50 |
| 6-WBAS | 2-1/2" | | 2-1/2" | 50 |
| 7-WBAS | 3" | | 3" | 25 |
| 8-WBAS | 3-1/2" | | 3-1/2" | 25 |
| 9-WBAS | 4" | 4" | 25 | |

STRUT CLAMPS



UNIVERSAL ONE-PIECE STRUT CLAMP



SK85ITZ

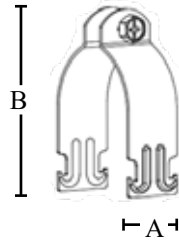

FEATURES

- For use with EMT/Rigid and IMC conduit
- All screws - 5/16" x 1-1/4" slotted hex head

APPLICATION

- Use to support stationary pipe and tubing lines from strut channel

MATERIAL/FINISH

- Steel/Zinc plated

CERTIFICATIONS

- UL Standard: UL 2239
- Fed. Spec: W-F-406E, W-F-406D
- NEMA: FB 1-2014

| PART # | EMT RIGID SIZE | STATIC LOAD (LBS.) | BOX QTY. | A | B |
|----------|----------------|--------------------|----------|-------|-------|
| SK85ITZ | 1/2" | 200 | 100 | 1.24" | 2.30" |
| SK125ITZ | 3/4" | 200 | 100 | 1.24" | 2.46" |
| SK165ITZ | 1" | 200 | 100 | 1.24" | 2.68" |
| SK205ITZ | 1-1/4" | 200 | 100 | 1.24" | 3.21" |
| SK245ITZ | 1-1/2" | 200 | 50 | 1.24" | 3.42" |
| SK325ITZ | 2" | 200 | 50 | 1.24" | 4" |
| SK405ITZ | 2-1/2" | 350 | 50 | 1.24" | 5" |
| SK485ITZ | 3" | 350 | 25 | 1.24" | 5.55" |
| SK565ITZ | 3-1/2" | 350 | 25 | 1.24" | 6" |
| SK645ITZ | 4" | 350 | 25 | 1.24" | 6.50" |

STRUT CLAMP FOR EMT CONDUIT



SCE-50

FEATURES

- Hex/slotted nut, square bolt

APPLICATION

- Secures EMT electrical conduit perpendicular to strut.

MATERIAL/FINISH

- Steel/Electroplated zinc

| PART # | EMT SIZE | INNER QTY. | MASTER QTY. |
|---------|----------|------------|-------------|
| SCE-50 | 1/2" | --- | 100 |
| SCE-75 | 3/4" | --- | 100 |
| SCE-100 | 1" | --- | 100 |
| SCE-125 | 1-1/4" | --- | 50 |
| SCE-150 | 1-1/2" | --- | 50 |
| SCE-200 | 2" | 1 | 50 |

STRUT CLAMP - FOR RIGID CONDUIT

STEEL OR 316 STAINLESS STEEL



STR50-SS

FEATURES

- Hex/slotted nut, square bolt

APPLICATION

- Secures Rigid electrical conduit perpendicular to strut

| PART # | RIGID SIZE | MATERIAL | BOX QTY. |
|-----------|------------|---------------------|----------|
| 2101 | 1/2" | ZINC PLATED STEEL | 100 |
| 2102 | 3/4" | | 100 |
| 2103 | 1" | | 50 |
| 2104 | 1-1/4" | | 50 |
| 2105 | 1-1/2" | | 50 |
| 2106 | 2" | | 50 |
| 2107 | 2-1/2" | | 50 |
| 2108 | 3" | | 25 |
| 2109 | 3-1/2" | | 25 |
| 2110 | 4" | | 25 |
| STR500 | 5" | | 25 |
| STR600 | 6" | | 25 |
| STR50-SS | 1/2" | 316 STAINLESS STEEL | 100 |
| STR75-SS | 3/4" | | 100 |
| STR100-SS | 1" | | 100 |
| STR125-SS | 1-1/4" | | 100 |
| STR150-SS | 1-1/2" | | 100 |
| STR200-SS | 2" | | 100 |
| STR250-SS | 2-1/2" | | 100 |
| STR300-SS | 3" | | 100 |
| STR350-SS | 3-1/2" | | 100 |
| STR400-SS | 4" | | 100 |
| STR500-SS | 5" | | 25 |
| STR600-SS | 6" | | 25 |

HANGING AND SUPPORT

STRUT CLAMP, ONE PIECE

SOFT SADDLE



OPCC-50



FEATURES

- Design has no screws or bolts to drop as you fit it to the strut channel
- Hex/slotted/phillips bolt

APPLICATION

- Secures electrical conduit or cable perpendicular to strut

MATERIAL/FINISH

- Steel/Galvanized

CERTIFICATIONS

- UL Listed

| PART # | RIGID SIZE | BOX QTY. |
|----------|------------|----------|
| OPCC-50 | 1/2" | 100 |
| OPCC-75 | 3/4" | 100 |
| OPCC-100 | 1" | 50 |

BEAM CLAMP, REVERSIBLE STAMPED

STEEL OR 304 STAINLESS STEEL



JFCS-3816SS



FEATURES

- Through-hole in beam clamps allows drop rod length adjustment

APPLICATION

- Adjusts to accommodate the field installation finished height

MATERIAL/FINISH

- Steel/Zinc plated or 304 Stainless steel

CERTIFICATIONS

- UL Listed

| PART # | MATERIAL | JAW OPENING | HOLE | BOX QTY. |
|-------------|---------------------|-------------|-----------|----------|
| JFCS-3816 | ZINC PLATED STEEL | 3/4" | 3/8" - 16 | 25 |
| JFCS-3816SS | 304 STAINLESS STEEL | 3/4" | 3/8" - 16 | 25 |

ONE PIECE STRUT CLAMP

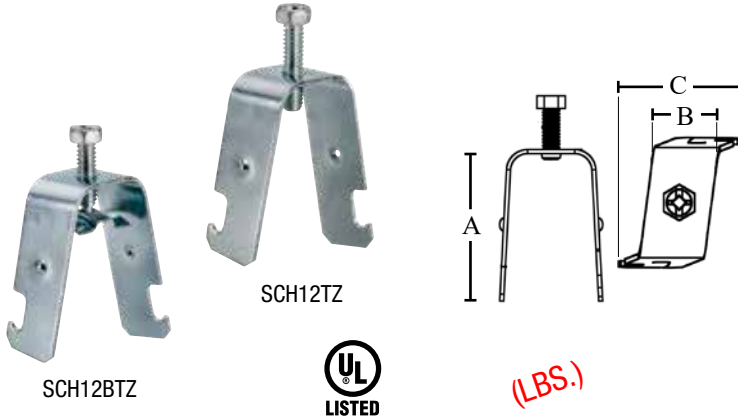

FEATURES

- Design has no screws or bolts to drop as you fit it to the strut channel
- Hex/slotted/Phillips bolt 1/4"-20 thread

APPLICATION

- Secures electrical conduit or cable perpendicular to strut

MATERIAL/FINISH

- Steel/Galvanized

CERTIFICATIONS

- UL Listed
- UL Standard: UL 2239

| PART # | BOOT FEATURE | EMT SIZE | RIGID SIZE | STATIC LOAD | BOX QTY. | A | B | C |
|----------|--------------|----------|------------|-------------|----------|-------|------|-------|
| SCH8TZ | NO BOOT | 1/2" | --- | 200 | 100 | 1.87" | .75" | 1.34" |
| SCH12TZ | NO BOOT | 3/4" | 1/2" | 200 | 100 | 2.13" | .75" | 1.38" |
| SCH16TZ | NO BOOT | 1" | 3/4" | 200 | 100 | 2.24" | .75" | 1.38" |
| SCH20TZ | NO BOOT | 1-1/4" | 1" | 200 | 100 | 2.48" | .75" | 1.38" |
| SCH6BTZ | BOOT | 3/8" | --- | 200 | 100 | 1.55" | .75" | 1.22" |
| SCH8BTZ | BOOT | 1/2" | --- | 200 | 100 | 1.87" | .75" | 1.34" |
| SCH12BTZ | BOOT | 3/4" | 1/2" | 200 | 100 | 2.13" | .75" | 1.38" |
| SCH16BTZ | BOOT | 1" | 3/4" | 200 | 100 | 2.24" | .75" | 1.38" |
| SCH20BTZ | BOOT | 1-1/4" | 1" | 200 | 100 | 2.48" | .75" | 1.18" |
| SCH24BTZ | BOOT | 1-1/2" | 1-1/4" | 350 | 50 | 2.78" | .75" | 1.2" |
| SCH32BTZ | BOOT | 2" | 1-1/2" | 350 | 50 | 3.29" | .75" | 1.2" |
| SCH40BTZ | BOOT | --- | 2" | 350 | 50 | 3.46" | .75" | .93" |
| SCH48BTZ | BOOT | 2-1/2" | 2-1/2" | 350 | 24 | 4" | .75" | .83" |
| SCH56BTZ | BOOT | 3" | 3" | 350 | 25 | 4.57" | .75" | .75" |
| SCH64BTZ | BOOT | 3-1/2" | 3-1/2" | 350 | 10 | 5.12" | .75" | .75" |
| SCH72BTZ | BOOT | 4" | 4" | 350 | 10 | 5.67" | .75" | .75" |

HANGING AND SUPPORT

ROD/WIRE HANGERS



CABLE/CONDUIT TO WIRE CLIP



PCS1TZ

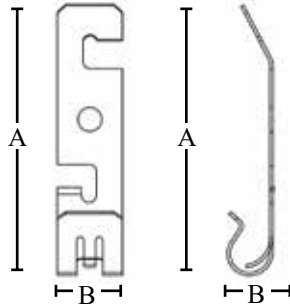

FEATURES

- Easy no-tool installation
- Attaches directly to drop wire with no additional bending

APPLICATION

- Provides support for cable and conduit from drop wire

MATERIAL/FINISH

- Spring Steel/GEOSEAL™

CERTIFICATIONS

- UL Standard: UL 2239



| PART # | STATIC LOAD (LBS.) | EMT CONDUIT SIZE | MC/AC CABLE SIZE | WIRE SIZE | HOLE SIZE | BOX QTY. | A | B |
|--------|--------------------|------------------|------------------|-----------|-----------|----------|-------|-------|
| PCS1TZ | 25 | --- | 14-2 – 10-3 | #8 – #12 | 1/4" | 100 | 3.11" | .748" |
| PCS2TZ | 25 | 1/2" & 3/4" | 10-3 – 6-3 | #8 – #12 | 1/4" | 100 | 3.52" | 1" |

CABLE/CONDUIT TO ROD/WIRE CLIP

PUSH-IN



4Z3412PTZ

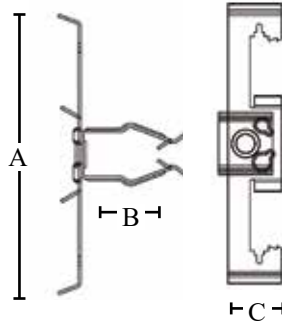

FEATURES

- Clip rotates 360° for conduit positioning
- Flange clip provides stability to the conduit clip
- Easy no-tool installation

APPLICATION

- Cable/conduit to rod/wire clips easily install to flanges or rods to support conduit, cables and boxes
- Equipped with a rotatable joint, the conduit clip rotates 360° to position conduit in different directions

MATERIAL/FINISH

- Spring Steel/GEOSEAL™

CERTIFICATIONS

- UL Standard: UL 2239



| PART # | FLANGE THICKNESS | EMT SIZE | RIGID SIZE | ROD SIZE | WIRE SIZE | BOX QTY. | A | B | C |
|-----------|------------------|----------|------------|----------|-----------|----------|-------|-------|-------|
| 4Z348PTZ | 1/8" – 3/8" | 1/2" | --- | 1/4" | #12 | 100 | 3.87" | 1.57" | .748" |
| 4Z3412PTZ | 1/8" – 3/8" | 3/4" | 1/2" | 1/4" | #12 | 100 | 3.87" | 1.67" | .748" |
| 4Z3416PTZ | 1/8" – 3/8" | 1" | 3/4" | 1/4" | #12 | 100 | 3.87" | 1.95" | .748" |
| 6Z348PTZ | 3/8" – 7/16" | 1/2" | --- | 3/8" | --- | 100 | 3.62" | 1.46" | .748" |
| 6Z3412PTZ | 3/8" – 7/16" | 3/4" | 1/2" | 3/8" | --- | 100 | 3.62" | 1.67" | .748" |
| 6Z3416PTZ | 3/8" – 7/16" | 1" | 3/4" | 3/8" | --- | 100 | 3.62" | 1.95" | .748" |

CABLE/CONDUIT TO ROD/WIRE CLAMP

SNAP-CLOSE



4Z346MTZ

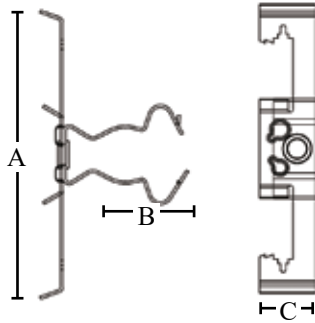

FEATURES

- Clip rotates 360° for conduit positioning
- Flange clip provides stability to the conduit clamp
- Easy no-tool installation

APPLICATION

- Cable/conduit to rod/wire clamps easily install to flanges or rods to support conduit, cables and boxes
- Equipped with a rotatable joint, the conduit clip rotates 360° to position conduit in different directions

MATERIAL/FINISH

- Spring Steel/GEOSEAL™

CERTIFICATIONS

- UL Standard: UL 2239



| PART # | FLANGE THICKNESS | MC/AC CABLE SIZE | EMT SIZE | RIGID SIZE | ROD SIZE | WIRE SIZE | BOX QTY. | A | B | C |
|------------|------------------|------------------|-------------|-------------|----------|-----------|----------|-------|-------|-------|
| 4Z346MTZ | 1/8" – 3/8" | 14-2 – 12-3 | --- | --- | 1/4" | #12 | 100 | 3.87" | 1.68" | .748" |
| 4Z3416MTZ | 1/8" – 3/8" | --- | 1" | 1" | 1/4" | #12 | 100 | 3.87" | 2.52" | .748" |
| 4Z34812MTZ | 1/8" – 3/8" | --- | 1/2" & 3/4" | 1/2" & 3/4" | 1/4" | --- | 100 | 3.87" | 2.05" | .748" |
| 6Z3416MTZ | 3/8" – 7/16" | --- | 1" | 1" | 3/8" | #12 | 100 | 3.62" | 2.52" | .748" |
| 6Z34812MTZ | 3/8" – 7/16" | --- | 1/2" & 3/4" | 1/2" & 3/4" | 3/8" | --- | 100 | 3.62" | 2.05" | .748" |

CABLE/CONDUIT TO ROD/WIRE CLIPS

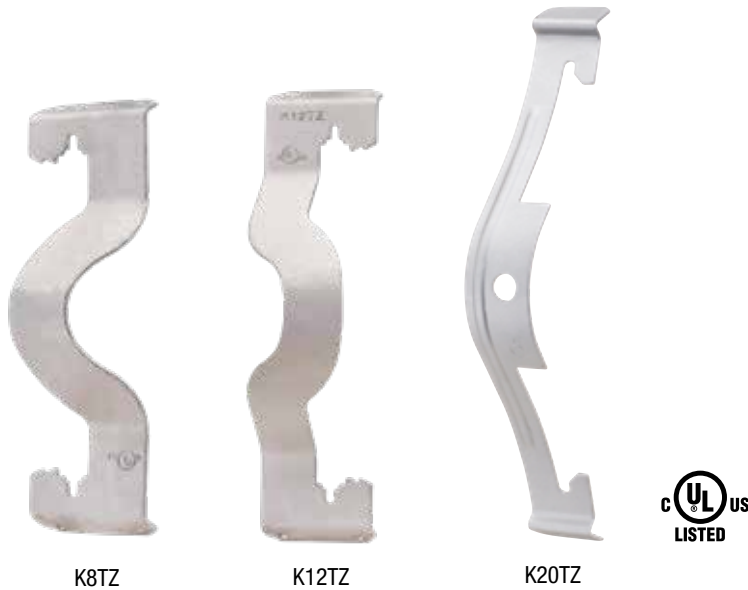

K8TZ

K12TZ

K20TZ

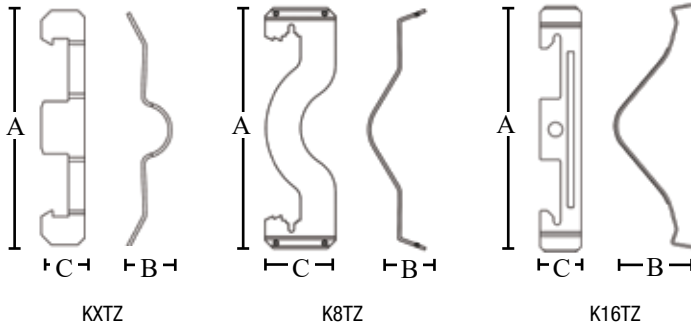

KXTZ

K8TZ

K16TZ

FEATURES

- Supports EMT, rigid, aluminum and NM conduit
- Spring Steel tightening feature keeps conduit and cables stable on rods or wire
- Easy no-tool installation

APPLICATION

- Cable/conduit to rod/wire no-tool installation clips are easily installed to flanges, rods, or wire to support conduit or cables.

MATERIAL/FINISH

- Spring Steel/GEOSEAL™

CERTIFICATIONS

- UL Standard: UL 2239



HANGING AND SUPPORT

| PART # | LOAD CAPACITY (LBS.) | | | A | B | C | BOX QTY. |
|--------|----------------------|-------------------|-----------------|-------|-------|-------|----------|
| | VERTICAL WIRE | HORIZONTAL FLANGE | VERTICAL FLANGE | | | | |
| KXTZ | --- | --- | --- | 2.71" | .782 | .504" | 100 |
| K8TZ | 50 | 100 | 15 | 2.90" | .815 | .626" | 100 |
| K12TZ | 50 | 100 | 15 | 4" | .839" | 1" | 100 |
| K16TZ | 50 | 100 | 15 | 4.53" | 1.50" | .756" | 100 |
| K20TZ | 50 | 100 | 22 | 5.59" | 1.78" | .756" | 100 |

CONDUIT DATA

| CONDUIT SIZE | #10, #12 WIRE | #8, #9 WIRE | 3/16", 1/4" ROD | 1/8" - 1/4" FLANGE | 5/16" - 3/8" FLANGE | 7/16" - 1/2" FLANGE |
|--------------|---------------|-------------|-----------------|--------------------|---------------------|---------------------|
| 1/2" EMT | K8TZ | K8TZ | K8TZ | K8TZ | K12TZ | K12TZ |
| 1/2" RIGID | K8TZ | K12TZ | K12TZ | K12TZ | K12TZ | K16TZ |
| 3/4" EMT | K12TZ | K12TZ | K12TZ | K12TZ | K16TZ | K16TZ |
| 3/4" RIGID | K12TZ | K12TZ | K16TZ | K16TZ | K20TZ | K20TZ |
| 1" EMT | --- | K16TZ | K16TZ | K16TZ | K20TZ | K20TZ |
| 1" RIGID | --- | --- | --- | K20TZ | K20TZ | K20TZ |
| 1-1/4" EMT | --- | K20TZ | K20TZ | K20TZ | --- | --- |

CABLE DATA

| CABLE SIZE | #12 WIRE | #8, #9, #10 WIRE |
|------------------|----------|------------------|
| 14-2, 14-3, 12-2 | KXTZ | KXTZ |
| 12-3 | KXTZ | K8TZ |

CABLE HANGER

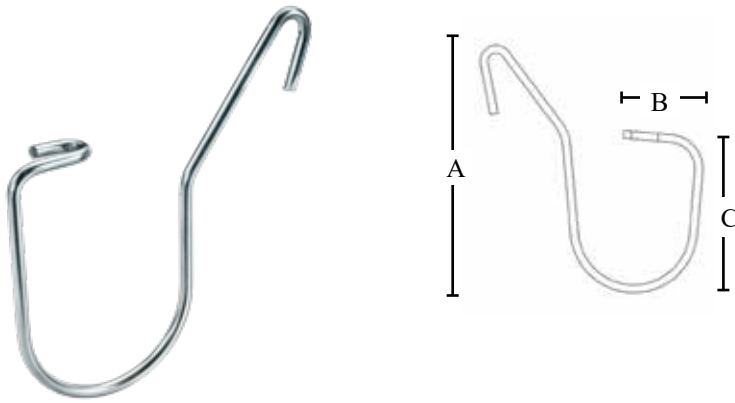

WMX6TZ



| PART # | HOOK DIAMETER | STATIC LOAD (LBS.) | A | B | C | BOX QTY. |
|--------|---------------|--------------------|-------|-------|-------|----------|
| WMX3TZ | 1-1/8" | 50 | 2.94" | 1.08" | 2.14" | 100 |
| WMX6TZ | 1-3/4" | 75 | 4.52" | 1.34" | 3.34" | 100 |

FEATURES

- Supports cables from beam, wire and flange clips

APPLICATION

- Provides convenient cable management for MC/AC and data cables when used with other Southwire spring steel fasteners

MATERIAL/FINISH

- Steel/Galvanized

CERTIFICATIONS

- UL Standard: UL 2239



HANGING AND SUPPORT

COMBINATION BOX/ CONDUIT HANGERS



BOX/CONDUIT HANGER



FEATURES

- Snap-close conduit clamps
- Center hole supports other Southwire fasteners attached to other structures

APPLICATION

- Conduit/box hangers are installed to drop wire, drop rod or other structures to support boxes in the center and conduit on either side

MATERIAL/FINISH

- Clamps: Spring steel
- Hangers: Galvanized steel
- GEOSEAL™

CERTIFICATIONS

- UL Standard: UL 2239

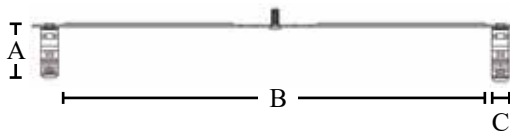

| PART # | EMT SIZE | FMC SIZE | MC/AC CABLE SIZE | HOLE SIZE | HOLE TYPE |
|------------|-------------|----------|------------------|-----------|-----------|
| 6MB18ATZ | --- | 3/8" | 14-2 - 12-3 | 1/4" | PLAIN |
| 16MB18ATZ | 1" | --- | --- | 1/4" | PLAIN |
| 812MB18ATZ | 1/2" & 3/4" | --- | --- | 1/4" | PLAIN |
| 812MB18STZ | 1/2" & 3/4" | --- | --- | --- | --- |

| PART # | SCREW OPTION | SCREW LENGTH | THREAD SIZE | BOX QTY. | A | B | C |
|------------|--------------|--------------|-------------|----------|-------|--------|------|
| 6MB18ATZ | NO | --- | --- | 25 | 1.68" | 18.11" | .63" |
| 16MB18ATZ | NO | --- | --- | 25 | 2.52" | 18.11" | .63" |
| 812MB18ATZ | NO | --- | --- | 25 | 2.05" | 18.11" | .63" |
| 812MB18STZ | YES | 9/16" | 1/4" - 20 | 25 | 2.05" | 18.11" | .63" |

HANGING AND SUPPORT

BOX/CONDUIT HANGER FROM ROD/WIRE



812MB18TZ

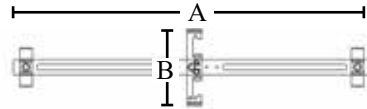

| PART # | BOX QTY. | A | B | C |
|-----------|----------|--------|-------|-------|
| 812MB18TZ | 25 | 18.11" | 3.87" | 1.92" |

FEATURES

- Supports 1/2", 3/4" EMT
- Fits 1/4" Rod, #12 Wire

APPLICATION

- Supports conduit from wires or rods

MATERIAL/FINISH

- Spring Steel/GEOSEAL™

CERTIFICATIONS

- UL Standard: UL 2239

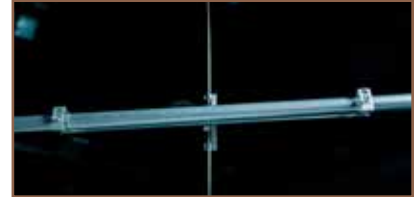

ADJUSTABLE BAR HANGER



BHA1



| PART # | JOIST OR STUD SPAN | BOX MOUNTING METHOD | MAX. RECOMMENDED STATIC FIXTURE SUPPORT (LBS.) | BOX QTY. |
|--------|--------------------|-------------------------------|--|----------|
| BHA1 | 16" TO 24" | BOX LOCK CLIP & THREADED STUD | 13 | 100 |

FEATURES

- Box clip installs in 1/2" knockouts, located on the bottom of boxes
- Versatile design allows boxes to be installed anywhere along the length of the bar
- Not designed or intended for ceiling fan support
- Galvanized steel
- UL rated for 13 lbs. on 16" centers

APPLICATION

- Adjustable length box bar hangers can adjust from 16" through 24" and are designed for non-standard stud spacing
- These box supports are compatible with 1-1/2" and 2-1/8" deep boxes and are made of galvanized steel allowing for installation of electrical boxes anywhere along the length of the bar
- Box supports can accommodate 13 lbs. maximum load, can be used to install electrical boxes between ceiling joists or wall studs, and are suitable for fixtures or luminaires installation

MATERIAL/FINISH

- Steel/Galvanized

CERTIFICATIONS

- UL rated for 13 lbs. on 16" centers

PIPE FITTINGS



ONE HOLE RIGID STRAP



531

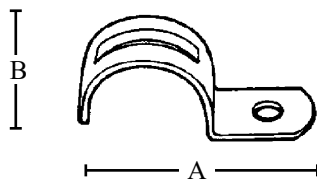

FEATURES

- Snap-on Rigid strap with one hole
- Greater load bearing capability
- Easy to install

APPLICATION

- Indoor or outdoor, use to secure EMT, Rigid or IMC conduit to wood, masonry or wherever greater load bearing is required

MATERIAL/FINISH

- Steel/Zinc plated

CERTIFICATIONS

- UL Standard: UL 2239
- Fed. Spec: W-F-406E, W-F-406D
- NEMA: FB 1-2014

| PART # | RIGID SIZE | BOX QTY. | A | B |
|--------|------------|----------|-------|-------|
| 531B | 3/8" | 100 | 1.81" | .562" |
| 531 | 1/2" | 50 | 1.91" | .625" |
| 532 | 3/4" | 50 | 2.21" | .75" |
| 533 | 1" | 25 | 2.57" | .875" |
| 534 | 1-1/4" | 20 | 2.79" | .88" |
| 535 | 1-1/2" | 20 | 3.69" | .899" |
| 536 | 2" | 10 | 4.17" | 1.14" |
| 517TZ* | 2-1/2" | 50 | 5" | 1.28" |
| 518TZ* | 3" | 25 | 5.55" | 1.28" |
| 519* | 3-1/2" | 25 | 6.37" | 1.28" |
| 520* | 4" | 25 | 6.87" | 1.28" |

*EMT and Rigid



ONE HOLE RIGID STRAP

316 STAINLESS STEEL



OHSSR-50



FEATURES

- Snap-on feature
- Inverted rib provides strength to keep cable secure
- 2-1/2" through 4" suitable for EMT conduit

APPLICATION

- Use to secure Rigid/IMC conduit in surface mount applications

MATERIAL/FINISH

- 316 Stainless steel

CERTIFICATIONS

- UL Listed

| PART # | RIGID SIZE | BOX QTY. |
|-----------|------------|----------|
| OHSSR-50 | 1/2" | 100 |
| OHSSR-75 | 3/4" | 100 |
| OHSSR-100 | 1" | 50 |
| OHSSR-125 | 1-1/4" | 50 |
| OHSSR-150 | 1-1/2" | 25 |
| OHSSR-200 | 2" | 25 |
| OHSSR-250 | 2-1/2" | 25 |
| OHSSR-300 | 3" | 10 |
| OHSSR-350 | 3-1/2" | 10 |
| OHSSR-400 | 4" | 10 |

HANGING AND SUPPORT

ONE HOLE EMT STRAP



511

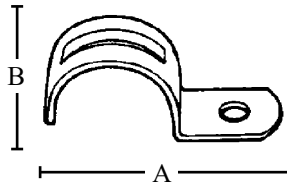

| PART # | EMT SIZE | BOX QTY. | A | B |
|-------------|----------|----------|-------|-------|
| 511 | 1/2" | 100 | 1.79" | .57" |
| EPS0075EGTZ | 3/4" | 50 | 1.96" | .62" |
| EPS0100EGTZ | 1" | 25 | 2.25" | .75" |
| EPS0125EGTZ | 1-1/4" | 20 | 2.85" | .88" |
| EPS0150EGTZ | 1-1/2" | 20 | 3.16" | .99" |
| EPS0200EGTZ | 2" | 10 | 3.93" | 1.10" |
| 517TZ* | 2-1/2" | 50 | 5" | 1.28" |
| 518TZ* | 3" | 25 | 5.55" | 1.28" |
| 519* | 3-1/2" | 25 | 6.37" | 1.28" |
| 520* | 4" | 25 | 6.87" | 1.28" |

*EMT and Rigid

FEATURES

- Snap-on EMT strap with one hole
- Inverted rib for strength
- Easy no-tool installation

APPLICATION

- Indoor or outdoor, use to support EMT conduit to wood, masonry or where greater load bearing is required

MATERIAL/FINISH

- Steel/Zinc plated

CERTIFICATIONS

- UL Standard: UL 2239
- Fed. Spec: W-F-406E, W-F-406D
- NEMA: FB 1-2014



ONE HOLE EMT STRAP

316 STAINLESS STEEL



OHSS-38



FEATURES

- Snap-on feature
- Inverted rib provides strength to keep cable secure

APPLICATION

- Use to secure EMT conduit in surface mount applications

MATERIAL/FINISH

- 316 Stainless steel

CERTIFICATIONS

- UL Listed (1/2" through 1")

| PART # | EMT SIZE | BOX QTY. |
|----------|----------|----------|
| OHSS-38 | 3/8" | 100 |
| OHSS-50 | 1/2" | 50 |
| OHSS-75 | 3/4" | 50 |
| OHSS-100 | 1" | 25 |
| OHSS-125 | 1-1/4" | 25 |
| OHSS-150 | 1-1/2" | 25 |
| OHSS-200 | 2" | 25 |
| OHSS-250 | 2-1/2" | 10 |
| OHSS-300 | 3" | 10 |
| OHSS-350 | 3-1/2" | 10 |
| OHSS-400 | 4" | 10 |

ONE HOLE STRAP

FOR RIGID/IMC CONDUIT



OHSR-38M



FEATURES

- Heavy-duty casting

APPLICATION

- Use to secure Rigid/IMC conduit in surface mount applications

MATERIAL/FINISH

- Malleable iron/Zinc plated

CERTIFICATIONS

- cULus Listed

| PART # | RIGID SIZE | INNER QTY. | MASTER QTY. |
|----------|------------|------------|-------------|
| OHSR-38M | 3/8" | --- | 50 |
| 561 | 1/2" | 25 | 250 |
| 562 | 3/4" | 25 | 250 |
| 563 | 1" | 25 | 125 |
| 564 | 1-1/4" | 20 | 100 |
| 565TZ | 1-1/2" | 10 | 100 |
| 566 | 2" | 10 | 50 |
| 567 | 2-1/2" | 5 | 25 |
| 568TZ | 3" | --- | 5 |
| 569 | 3-1/2" | --- | 5 |
| 570 | 4" | --- | 5 |
| 570A | 5" | --- | 2 |
| 570B | 6" | --- | 2 |

HANGING AND SUPPORT

ONE HOLE RIGID CLAMP BACK SPACER



481



FEATURES

- For use with malleable or aluminum straps

APPLICATION

- Use to provide space between conduit and mounting surface

MATERIAL/FINISH

- Malleable iron/Zinc plated

CERTIFICATIONS

- cULus Listed

| PART # | RIGID SIZE | INNER QTY. | MASTER QTY. |
|--------|------------|------------|-------------|
| 481 | 1/2" | 25 | 250 |
| 482 | 3/4" | 25 | 250 |
| 483 | 1" | 25 | 125 |
| 484 | 1-1/4" | 20 | 100 |
| 485 | 1-1/2" | 10 | 100 |
| 486 | 2" | 10 | 50 |
| 487 | 2-1/2" | 5 | 25 |
| 488 | 3" | N/A | 10 |
| 489 | 3-1/2" | N/A | 10 |
| 489A | 4" | N/A | 10 |
| 489B | 5" | N/A | 2 |
| 489C | 6" | N/A | 2 |

ONE HOLE SE/SEU STRAP



232A

| PART # | WIRE SIZES | INNER QTY. | MASTER QTY. |
|--------|----------------|------------|-------------|
| 232A | 3 #3 OR #2 | 100 | 1000 |
| 282A | 3 #1/0 OR #2/0 | 25 | 250 |
| 284A | 3 #3/0 OR #4/0 | 20 | 100 |

FEATURES

- Wide wire range
- Stamped aluminum

APPLICATION

- Use to secure SE & SEU service entrance cable in surface mount applications

MATERIAL/FINISH

- Aluminum

ONE HOLE NM STRAP



510RX

| PART # | WIRE SIZES | INNER QTY. | MASTER QTY. |
|--------|---|------------|-------------|
| 510RX | 14, 12, 10 IN 2 OR 3 CONDUCTOR, WITH OR WITHOUT GROUND. ALSO 14 IN UF | 100 | 1000 |

FEATURES

- Inverted rib provides strength to keep cable secure

APPLICATION

- Use to secure Romex® Brand nonmetallic sheathed cable in surface mount applications

MATERIAL/FINISH

- Steel/Zinc plated

TWO HOLE SE/SEU STRAP



506

| PART # | FOR WIRE SIZES | INNER QTY. | MASTER QTY. |
|--------|----------------|------------|-------------|
| 506 | 3 #8 OR #6 | 100 | 500 |
| 507 | 3 # 4 OR #3 | 100 | 500 |
| 508 | #1/0 OR #2/0 | 25 | 250 |
| 509 | #4/0 | 20 | 100 |

FEATURES

- Inverted rib provides strength to keep cable secure
- Snap-on Rigid strap with two holes

APPLICATION

- Use to secure SE & SEU service entrance cable in surface mount applications

MATERIAL/FINISH

- Steel/Galvanized

TWO HOLE EMT STRAP

ZINC PLATED STEEL



| PART # | EMT SIZE | BOX QTY. |
|--------|----------|----------|
| THS-25 | 1/4" | 50 |
| THS-38 | 3/8" | 50 |
| 521TZ | 1/2" | 500 |
| 522 | 3/4" | 500 |
| 523 | 1" | 250 |
| 524 | 1-1/4" | 50 |
| 525 | 1-1/2" | 50 |
| 526 | 2" | 50 |
| 527 | 2-1/2" | 50 |
| 528TZ | 3" | 25 |
| 529TZ | 3-1/2" | 25 |
| 530TZ | 4" | 20 |

FEATURES

- Snap-on EMT strap with two holes
- Inverted rib provides strength to keep cable secure
- Easy to install

APPLICATION

- Use to secure EMT conduit in surface mount applications

MATERIAL/FINISH

- Steel/Zinc plated

316 STAINLESS STEEL



| PART # | EMT SIZE | BOX QTY. |
|----------|----------|----------|
| THSS-38 | 3/8" | 50 |
| THSS-50 | 1/2" | 50 |
| THSS-75 | 3/4" | 50 |
| THSS-100 | 1" | 25 |
| THSS-125 | 1-1/4" | 25 |
| THSS-150 | 1-1/2" | 25 |
| THSS-200 | 2" | 25 |
| THSS-250 | 2-1/2" | 25 |
| THSS-300 | 3" | 10 |
| THSS-350 | 3-1/2" | 10 |
| THSS-400 | 4" | 10 |

FEATURES

- Snap-on EMT strap with two holes
- Inverted rib provides strength to keep cable secure
- Easy to install

APPLICATION

- Use to secure EMT conduit in surface mount applications

MATERIAL/FINISH

- Steel/316 Stainless steel

TWO HOLE RIGID STRAP



THSSR-50



FEATURES

- Inverted rib provides strength to keep cable secure
- Snap-on Rigid strap with two holes

APPLICATION

- Indoor or outdoor, use to secure EMT, Rigid or IMC conduit to wood, masonry or where greater load bearing is required

CERTIFICATIONS

- cULus Listed (except 123)
- UL Listed (for THSSR*)

| PART # | MATERIAL | RIGID SIZE | INNER QTY | BOX QTY. |
|-----------|---------------------|------------|-----------|----------|
| 123 | ZINC PLATED STEEL | 3/8" | 100 | 500 |
| 124 | | 1/2" | 100 | 500 |
| 125 | | 3/4" | 50 | 250 |
| 126 | | 1" | 25 | 125 |
| 127 | GALVANIZED STEEL | 1-1/4" | --- | 50 |
| 128 | | 1-1/2" | --- | 50 |
| 129 | | 2" | --- | 50 |
| 527 | | 2-1/2" | --- | 50 |
| 528TZ | | 3" | --- | 25 |
| 529TZ | | 3-1/2" | --- | 25 |
| 530TZ | | 4" | --- | 20 |
| THSSR-50 | 316 STAINLESS STEEL | 1/2" | --- | 50 |
| THSSR-75 | | 3/4" | --- | 50 |
| THSSR-100 | | 1" | --- | 25 |
| THSSR-125 | | 1-1/4" | --- | 25 |
| THSSR-150 | | 1-1/2" | --- | 25 |
| THSSR-200 | | 2" | --- | 25 |
| THSSR-250 | | 2-1/2" | --- | 25 |
| THSSR-300 | | 3" | --- | 10 |
| THSSR-350 | | 3-1/2" | --- | 10 |
| THSSR-400 | | 4" | --- | 10 |

HANGING AND SUPPORT

STRUCTURAL ATTACHMENTS

**Solutions to attach and support
electrical networks from building
structures**

BEAM/PURLIN

ROD/WIRE FASTENERS

FASTENERS/HARDWARE

BEAM/PURLIN



HAMMER-ON FLANGE CLIP



2H4TZ

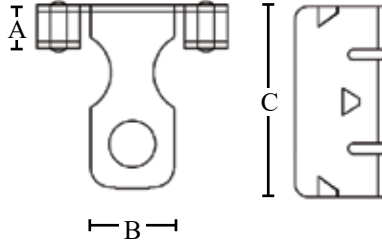

| PART # | FLANGE SIZE | STATIC LOAD (LBS.) | BOX QTY. | A | B | C |
|---------|---------------|--------------------|----------|-------|-------|-------|
| 2H4TZ | 3/32" – 9/64" | 160 | 100 | .26" | .496" | 1.13" |
| 4H24TZ | 1/8" – 1/4" | 200 | 100 | .37" | .512" | 1.26" |
| 4H58TZ | 5/16" – 1/2" | 200 | 100 | .606" | .512" | 1.26" |
| 4H912TZ | 9/16" – 3/4" | 200 | 100 | .866" | .512" | 1.26" |

FEATURES

- Hammer-on installation
- Provides 1/4" hanger hole
- Side mount

APPLICATION

- Provides an attachment solution to beam flanges for wire, hooks, and chains

MATERIAL/FINISH

- Spring Steel/GEOSEAL™

CERTIFICATIONS

- UL Standard: UL 2239



FLANGE MOUNT THREADED ROD SUPPORT



4TI58TZ

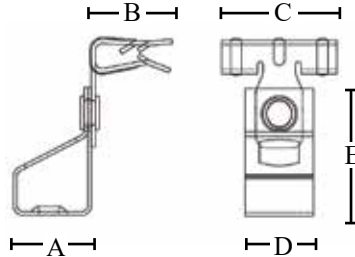

| PART # | FLANGE THICKNESS | STATIC LOAD (LBS.) | BOX QTY. | A | B | C | D | E |
|----------|------------------|--------------------|----------|------|-------|-------|-------|-------|
| 4TI24TZ | 1/8" - 1/4" | 200 | 100 | .85" | .866" | 1.26" | .748" | 1.48" |
| 4TI58TZ | 5/16" - 1/2" | 200 | 100 | .85" | .866" | 1.26" | .748" | 1.48" |
| 4TI912TZ | 9/16" - 3/4" | 200 | 100 | .85" | .866" | 1.26" | .748" | 1.48" |

FEATURES

- Rotatable joint ensures rod maintains a vertical position
- Hammer-on installation

APPLICATION

- Supports threaded rods from beams with flange clip

MATERIAL/FINISH

- Spring Steel/GEOSEAL™

CERTIFICATIONS

- UL Standard: UL 2239



DECK ROD HANGER



DH6TITZ

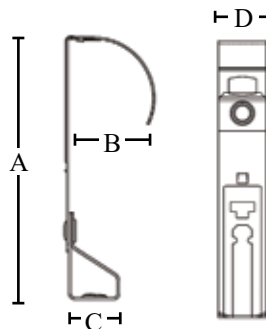

| PART # | STATIC LOAD (LBS.) | BOX QTY. | A | B | C | D |
|---------|--------------------|----------|-------|-------|------|-------|
| DH6TITZ | 160 | 100 | 4.90" | 1.49" | .85" | .748" |

FEATURES

- Supports 3/8" threaded rods

APPLICATION

- Attaches to deck tab to support threaded rods

MATERIAL/FINISH

- Spring Steel/GEOSEAL™

CERTIFICATIONS

- UL Standard: UL 2239



FLANGE MOUNT PLAIN ROD SUPPORT



6A24TZ

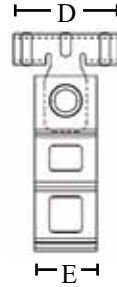
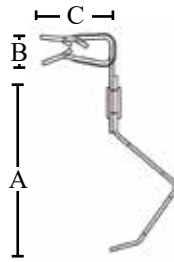

FEATURES

- Rotatable joint ensures rod maintains a vertical position
- Hammer-on installation

APPLICATION

- Supports plain rods from beams with flange clip

MATERIAL/FINISH

- Spring Steel/GEOSEAL™

CERTIFICATIONS

- UL Standard 2239



| PART # | FLANGE SIZE | STATIC LOAD (LBS.) | BOX QTY. | A | B | C | D | E |
|---------|--------------|--------------------|----------|-------|-------|-------|-------|-------|
| 6A24TZ | 1/8" – 1/4" | 200 | 100 | 2.12" | .157" | .886" | 1.26" | .748" |
| 6A912TZ | 9/16" – 3/4" | 200 | 100 | 2.12" | .568" | .886" | 1.26" | .748" |

"Z" PURLIN ROD CLAMP



AF146TITZ

1224TITZ



FEATURES

- Designed to fit angle purlin flanges
- Rotatable joint ensures rod position maintains a vertical direction
- Hammer-on installation

APPLICATION

- Conforms to the angle of purlin to suspend plain or threaded rods

MATERIAL/FINISH

- Spring Steel/GEOSEAL™

CERTIFICATIONS

- UL Standard 2239

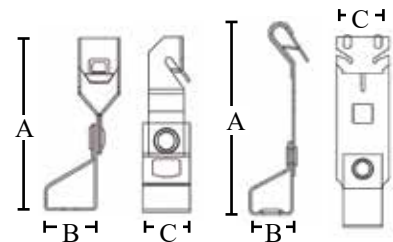

| PART # | FLANGE SIZE | MOUNTING OPTION | ROD SIZE | HOLE TYPE | BOX QTY. | A | B | C |
|-----------|--------------|-----------------|----------|-----------|----------|-------|-------|-------|
| 1224TITZ | 3/32" MAX | SIDE | 1/4" | THREADED | 100 | 3.28" | .85" | .748" |
| 1226TITZ | 3/32" MAX | SIDE | 3/8" | THREADED | 100 | 3.28" | .85" | .748" |
| AF144TITZ | 1/16" – 1/4" | FRONT | 1/4" | THREADED | 100 | 4.30" | .827" | 1" |
| AF146TTZ | 1/16" – 1/4" | FRONT | 3/8" | PLAIN | 100 | 4.30" | .827" | 1" |
| AF146TITZ | 1/16" – 1/4" | FRONT | 3/8" | THREADED | 100 | 4.30" | .827" | 1" |

"Z" PURLIN CLIP



122TZ

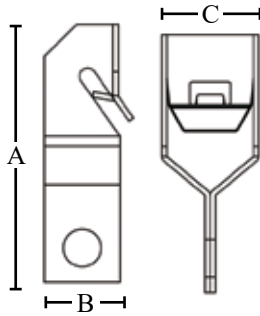

| PART # | BOX QTY. | A | B | C |
|--------|----------|-------|-------|-------|
| 122TZ | 100 | 1.88" | .551" | .709" |

FEATURES

- 1/4" support hole
- Hammer-on installation
- Side mount
- 3/32" max flange thickness

APPLICATION

- Conforms to the angle of purlin to support wire, chains, and hooks.

MATERIAL/FINISH

- Spring Steel/GEOSEAL™

CERTIFICATIONS

- UL Standard 2239



ANGLED PURLIN STRAP HANGER



MSR122TZ



MSS122TZ



| PART # | STRAP DIRECTION TO BEAM | STATIC LOAD (LBS.) | BOX QTY. | A | B | C | D |
|----------|-------------------------|--------------------|----------|-------|-------|-------|-------|
| MSS122TZ | PARALLEL | 100 | 50 | 2.49" | 2.24" | .539" | .708" |
| MSR122TZ | RT. ANGLE | 100 | 50 | 3.19" | 2.24" | .709" | .709" |

FEATURES

- Hammer-on installation
- 3/32" max flange thickness
- 1-1/4" max strap width

APPLICATION

- Conforms to the angle of purlin to support pipe, ducts, and other attachments with straps

MATERIAL/FINISH

- Spring Steel/GEOSEAL™
- Steel/Galvanized

CERTIFICATIONS

- UL Standard 2239

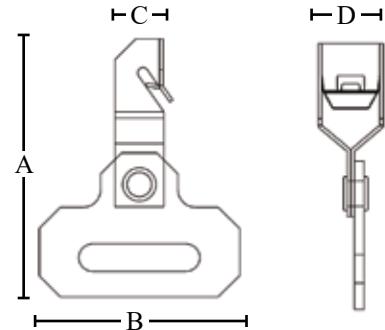

CONDUIT TO PURLIN CLAMP



123812MTZ

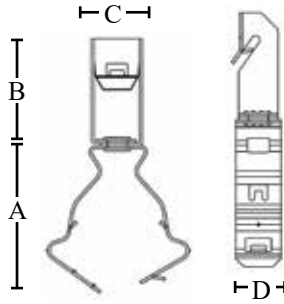

FEATURES

- Hammer-on installation
- Snap-close conduit clamp pivots 360° for easy positioning
- Supports 1/2" and 3/4" EMT
- 3/32" max flange

APPLICATION

- Supports EMT and Rigid conduit from angled purlins

MATERIAL/FINISH

- Spring Steel/GEOSEAL™

CERTIFICATIONS

- UL Standard 2239

| PART # | BOX QTY. | A | B | C | D |
|-----------|----------|-------|-------|-------|-------|
| 123812MTZ | 100 | 2.05" | 1.49" | .709" | .630" |

CONDUIT TO BEAM CLIPS

BOTTOM MOUNT



BC12PTZ

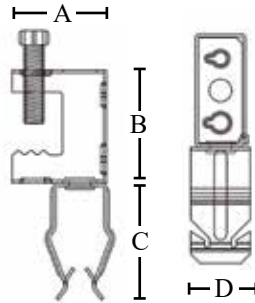

FEATURES

- Riveted conduit hanger rotates 360° to accommodate various directions of conduit
- Light-duty beam clamp provides a 25 lbs. static load capacity
- Additional 10 – 24 and 1/4" – 20 mounting holes on beam clamp

APPLICATION

- Push-in conduit hanger/beam clip assemblies are used when EMT or Rigid conduit must be supported below a structural beam

MATERIAL/FINISH

- Spring Steel/GEOSEAL™

CERTIFICATIONS

- UL Standard 2239

| PART # | EMT SIZE | FLANGE SIZE | THREAD HOLE SIZE | LOAD CAPACITY (LBS.) |
|------------|----------|-------------|---------------------|----------------------|
| BC8PTZ | 1/2" | 1/2" | 10 – 24 & 1/4" – 20 | 100 |
| BC12PTZ | 3/4" | 1/2" | 10 – 24 & 1/4" – 20 | 100 |
| CHP-100-TM | 1" | 1/2" | 10 – 24 & 1/4" – 20 | 100 |

| PART # | BOX QTY. | A | B | C | D |
|------------|----------|-------|-------|-------|-------|
| BC8PTZ | 100 | 1.18" | 1.42" | 1.46" | .748" |
| BC12PTZ | 100 | 1.18" | 1.42" | 1.67" | .748" |
| CHP-100-TM | 50 | 1.18" | 1.42" | 2.37" | .748" |



CONDUIT TO BEAM CLIPS

SIDE MOUNT



CHP-50-SM



| PART # | EMT | FLANGE SIZE | BOX QTY. |
|------------|------|-------------|----------|
| CHP-50-SM | 1/2" | 1/2" | 50 |
| CHP-75-SM | 3/4" | 1/2" | 50 |
| CHP-100-SM | 1" | 1/2" | 50 |

FEATURES

- Riveted conduit hanger rotates 360° to accommodate various directions of conduit, perpendicular to beam edge
- Light-duty beam clamp provides a 25 lbs. static load capacity
- Additional 10-24 and 1/4"-20 mounting holes on beam clamp

APPLICATION

- Push-in conduit hanger/beam clip assemblies are used when EMT or Rigid conduit must be attached below a structural beam

MATERIAL/FINISH

- Spring Steel

CONDUIT BEAM CLAMP

BOTTOM MOUNT



BC16MTZ

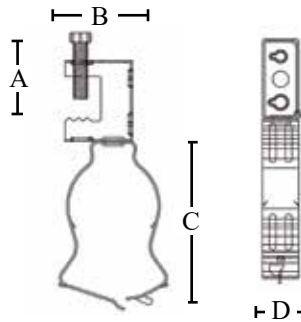

FEATURES

- Snap-close clip to secure conduit
- 1/2" max flange size

APPLICATION

- Snap-close conduit hanger/beam clamp assemblies are used when EMT or Rigid conduits must be supported below a structural beam

MATERIAL/FINISH

- Spring Steel/GEOSEAL™

CERTIFICATIONS

- UL Standard 2239

| PART # | CONDUIT SIZE | STATIC LOAD (LBS.) | BOX QTY. | A | B | C | D |
|----------|--------------|--------------------|----------|-------|-------|-------|------|
| BC812MTZ | 1/2" OR 3/4" | 100 | 100 | 1.42" | 1.18" | 2.05" | .63" |
| BC16MTZ | 1" | 100 | 100 | 1.42" | 1.18" | 2.52" | .63" |
| BC20MTZ | 1-1/4" | 100 | 100 | 1.42" | 1.18" | 2.96" | .63" |
| BC24MTZ | 1-1/2" | 100 | 50 | 1.42" | 1.18" | 3.18" | .63" |
| BC32MTZ | 2" | 100 | 50 | 1.42" | 1.18" | 3.88" | .63" |



HANGING AND SUPPORT

CONDUIT BEAM CLAMP

SIDE MOUNT

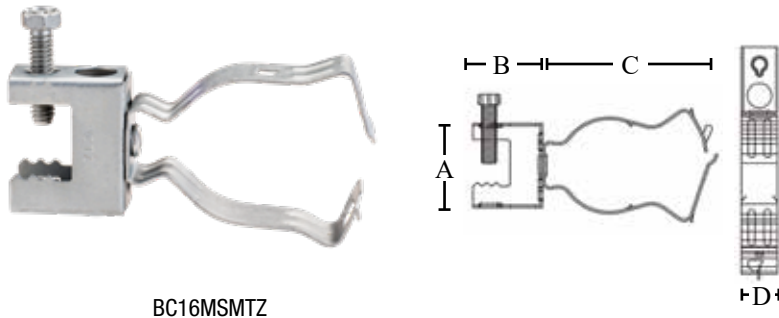

BC16MSMTZ



| PART # | CONDUIT SIZE | STATIC LOAD (LBS.) | BOX QTY. | A | B | C | D |
|------------|--------------|--------------------|----------|-------|-------|-------|------|
| BC812MSMTZ | 1/2" OR 3/4" | 25 | 100 | 1.42" | 1.18" | 2.05" | .63" |
| BC16MSMTZ | 1" | 25 | 100 | 1.42" | 1.18" | 2.52" | .63" |
| BC20MSMTZ | 1-1/4" | 25 | 100 | 1.42" | 1.18" | 2.96" | .63" |
| BC24MSMTZ | 1-1/2" | 25 | 50 | 1.42" | 1.18" | 3.18" | .63" |
| BC32MSMTZ | 2" | 25 | 50 | 1.42" | 1.18" | 3.88" | .63" |

FEATURES

- Snap-close clip to secure conduit
- 1/2" max flange size

APPLICATION

- Snap-close conduit hanger/beam clamp assemblies are used when EMT or Rigid conduits must be supported to a structural beam

MATERIAL/FINISH

- Spring Steel/GEOSEAL™

CERTIFICATIONS

- UL Standard 2239



FLANGE CLIP WITH STUD

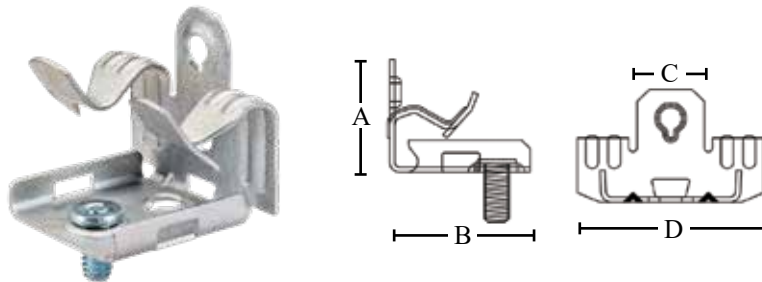

M912STZ



| PART # | FLANGE THICKNESS | LOAD CAPACITY (LBS.) | | |
|---------|------------------|----------------------|----------------|----------------|
| | | VERTICAL ROD | HORIZONTAL ROD | VERTICAL STRAP |
| M24STZ | 1/8" - 1/2" | 100 | 25 | 75 |
| M58STZ | 5/16" - 1/2" | 100 | 25 | 75 |
| M912STZ | 9/16" - 3/4" | 100 | 25 | 75 |

| PART # | BOX QTY. | A | B | C | D |
|---------|----------|-------|-------|-------|-------|
| M24STZ | 100 | 1.06" | 1.32" | .630" | 1.75" |
| M58STZ | 100 | 1.34" | 1.36" | .630" | 1.75" |
| M912STZ | 100 | 1.63" | 1.46" | .630" | 1.75" |

FEATURES

- Hammer-on installation
- 1/4"-20 Threaded stud; 3/8" length
- Accommodates 1/4" size rod
- Bottom mount

APPLICATION

- Attaches to beam flanges to support rods or straps
- Threaded stud feature provides support for outlet boxes

MATERIAL/FINISH

- Spring Steel/GEOSEAL™

CERTIFICATIONS

- UL Standard 2239



THREADED ROD FLANGE CLIP SUPPORT



M912TZ

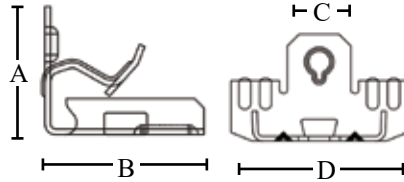

FEATURES

- Hammer-on installation
- Accommodates 1/4" rod size
- Bottom mount

APPLICATION

- Attaches to beam flanges to support rods, boxes, fixtures, or other necessary attachments

MATERIAL/FINISH

- Spring Steel/GEOSEAL™

CERTIFICATIONS

- UL Standard 2239

| PART # | FLANGE THICKNESS | LOAD CAPACITY (LBS.) | | |
|--------|------------------|----------------------|----------------|----------------|
| | | VERTICAL ROD | HORIZONTAL ROD | VERTICAL STRAP |
| M24TZ | 1/8" – 1/4" | 100 | 25 | 75 |
| M58TZ | 5/16" – 1/2" | 100 | 25 | 75 |
| M912TZ | 9/16" – 3/4" | 100 | 25 | 75 |

| PART # | BOX QTY. | A | B | C | D |
|--------|----------|-------|-------|------|-------|
| | | | | | |
| M58TZ | 100 | 1.34" | 1.36" | .63" | 1.75" |
| M912TZ | 100 | 1.63" | 1.46" | .63" | 1.75" |



STRAP HANGER FLANGE CLIP



MSS912TZ

MSR58TZ



| PART # | FLANGE SIZE | STRAP DIRECTION TO BEAM | STATIC LOAD (LBS.) |
|----------|--------------|-------------------------|--------------------|
| MSS24TZ | 1/8" – 1/4" | PARALLEL | 200 |
| MSS58TZ | 5/16" – 1/2" | PARALLEL | 200 |
| MSS912TZ | 9/16" – 3/4" | PARALLEL | 200 |
| MSR58TZ | 5/16" – 1/2" | RIGHT ANGLE | 200 |

| PART # | BOX QTY. | A | B | C | D |
|----------|----------|-------|-------|-------|-------|
| MSS24TZ | 50 | 2.19" | .886" | 1.60" | 2.24" |
| MSS58TZ | 50 | 2.46" | .886" | 1.60" | 2.24" |
| MSS912TZ | 50 | 2.70" | .886" | 1.60" | 2.24" |
| MSR58TZ | 50 | 2.77" | .866" | 1.26 | 2.24 |

FEATURES

- Hammer-on installation
- Strap width 1-1/4" max

APPLICATION

- Attaches to beam flange to support pipes, ducts, or other attachments with straps.

MATERIAL/FINISH

- Spring Steel/GEOSEAL™

CERTIFICATIONS

- UL Standard 2239

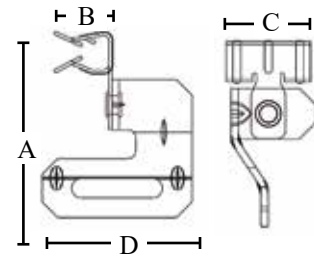
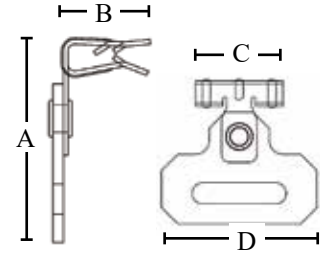

VERTICAL ANGLED FLANGE HANGER



VF14TZ



| PART # | BOX QTY. | A | B | C |
|--------|----------|-------|----|-------|
| VF14TZ | 100 | 2.94" | 1" | .354" |

FEATURES

- Fits purlin and bar joists with 1/16" to 1/4" flange

APPLICATION

- Use to support wire, chains, and S-hooks from vertical purlins
- Hammer-on installation

MATERIAL/FINISH

- Spring Steel/GEOSEAL™

CERTIFICATIONS

- UL Standard 2239

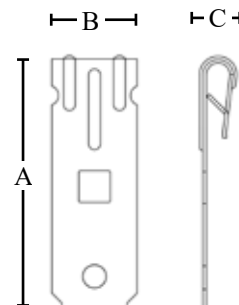

ANGLE FLANGE HANGER



AF14TZ



| PART # | STATIC LOAD (LBS.) | BOX QTY. | A | B | C | D |
|--------|--------------------|----------|-------|----|-------|-------|
| AF14TZ | 100 | 100 | 2.91" | 1" | .701" | .486" |

FEATURES

- Supports flanges from 1/16" to 1/4"
- 1/4" support hole
- Hammer-on installation

APPLICATION

- Designed to hang from angle purlin to provide support for wires, chains, and hooks

MATERIAL/FINISH

- Spring Steel/GEOSEAL™

CERTIFICATIONS

- UL Standard 2239

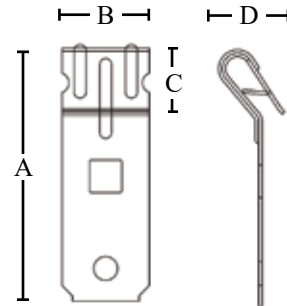

6-1/4" WIDE MOUTH BEAM CLAMP

LIGHT-DUTY



BC-1420-XWM



FEATURES

- 1/4"-20 thread impressions
- Stamped steel

APPLICATION

- Light duty beam clamp supports loads from structural beams

MATERIAL/FINISH

- Steel

| PART # | JAW | HOLE THREAD | BOX QTY. |
|-------------|--------|-------------|----------|
| BC-1420-XWM | 6-1/4" | 1/4"-20 | 20 |

CONDUIT HANGER WITH STEEL BEAM CLAMP ASSEMBLY



CHBC-50



FEATURES

- Riveted conduit hanger rotates 360° to accommodate various directions of conduit
- Stamped steel construction and hardened set screw provides a 100 lbs. static load capacity
- Additional 1/4" – 20 mounting hole on back of beam clamp

APPLICATION

- Conduit hanger/beam clamp assemblies are used when EMT or Rigid conduit must be supported below a structural beam

MATERIAL/FINISH

- Zinc plated

| PART # | FOR EMT SIZE | FOR RIGID SIZE | BOX QTY. |
|----------|--------------|----------------|----------|
| CHBC-50 | 1/2" | 1/2" | 50 |
| CHBC-75 | 3/4" | 3/4" | 50 |
| CHBC-100 | 1" | 1" | 50 |
| CHBC-125 | 1-1/4" | --- | 50 |
| CHBC-150 | 1-1/2" | 1-1/4" | 50 |
| CHBC-175 | --- | 1-1/2" | 50 |
| CHBC-200 | 2" | 2" | 50 |

BEAM CLAMP 316 STAINLESS STEEL



MBC-3816-SS

FEATURES

- Tapped holes on side and bottom

APPLICATION

- Stainless steel beam clamps are used to support conduit hangers, bridle rings and drop rods in harsh environments where corrosion is an issue

MATERIAL/FINISH

- Body and Set Screw: Steel/316 Stainless

| PART # | FLANGE THICKNESS | SIDE/BOTTOM THREADED HOLES | STATIC LOAD (LBS) | BOX QTY. |
|-------------|------------------|----------------------------|-------------------|----------|
| MBC-1420-SS | 3/8" | 1/4" – 20 | 250 | 50 |
| MBC-3816-SS | 3/8" | 3/8" – 16 | 500 | 25 |

BEAM CLAMPS



BC-1024

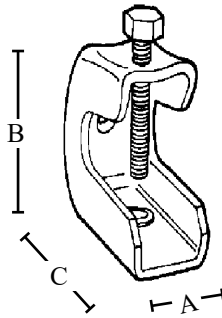

FEATURES

- Side and bottom tapped holes

APPLICATION

- Light duty beam clamp supports loads from structural beams

CERTIFICATIONS

- UL listed or cULus Listed



| PART # | MATERIAL | ROD SIZE | JAW OPENING | BOX QTY. | A | B | C |
|-------------|---------------------|-----------|-------------|----------|-------|--------|-------|
| BC-1024* | ZINC PLATED STEEL | 10 - 24 | .59" | 100 | .92" | 1.40" | 1.63" |
| BC200TZ** | | 1/4" - 20 | .59" | 100 | .92" | 1.40" | 1.63" |
| BC400TZ** | | 3/8" - 16 | .94" | 50 | 1.21" | 2.062" | 2.25" |
| BC-1420-SS* | 316 STAINLESS STEEL | 1/4" - 20 | .59" | 100 | .92" | 1.40" | 1.63" |
| BC-3816-SS* | | 3/8" - 16 | .94" | 25 | 1.21" | 2.062" | 2.25" |

* UL listed | ** cULus listed

SPRING STEEL



BCTZ

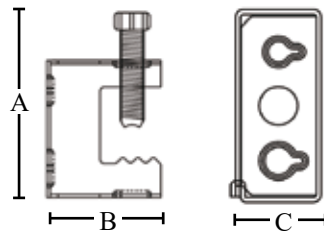

FEATURES

- Supports flanges up to 1/2"
- Holes in the back and bottom supports #10-24 and 1/2"- 20 threaded bridle rings

APPLICATION

- Clamps to flanges to support a variety of attachments from beams.

MATERIAL/FINISH

- Steel/GEOSEAL™

CERTIFICATIONS

- UL Standard: UL 2239



| PART # | STATIC LOAD (LBS.) | BOX QTY. | A | B | C |
|--------|--------------------|----------|-------|-------|------|
| BCTZ | 100 | 100 | 1.42" | 1.18" | .63" |

BEAM CLAMPS

MALLEABLE IRON



26



| PART # | SIZE | JAW OPENING | SIDE/BOTTOM THREADED HOLES | STATIC LOAD (LBS.) | BOX QTY. |
|--------|--------|-------------|-------------------------------|-----------------------|-------------|
| 26 | 1" | 3/4" | 1/4"-20 | 450 | 50 |
| 27 | 2" | 7/8" | 3/8"-16 | 1300 | 10 |
| 29 | 2-1/2" | 1-3/16" | 1/2"-13 | 1700 | 10 |

FEATURES

- Tapped holes on side and bottom

APPLICATION

- Malleable iron beam clamps are used to support conduit hangers, bridle rings and drop rods

MATERIAL/FINISH

- Malleable iron/Zinc plated

CERTIFICATIONS

- UL Listed, CSA Listed

SLIM-BODY - MALLEABLE IRON



MBC-3816EV



| PART # | JAW OPENING | ROD SIZE | STATIC LOAD (LBS.) | BOX QTY. |
|-------------|-------------|----------|--------------------|----------|
| MBC-3816EV* | 3/4" | 3/8" | 900 | 50 |
| 122** | 3/4" | 1/4"-20 | 125 | 50 |
| 123TZ** | 7/8" | 3/8"-16 | 300 | 50 |
| 123A** | 3/4" | 3/8"-16 | 300 | 50 |
| 124TZ** | 1-1/8" | 1/2"- 13 | 600 | 25 |

* UL listed | ** No UL

FEATURES

- Tapped holes on side and bottom

APPLICATION

- Malleable iron beam clamps are used to support conduit hangers, bridle rings and drop rods

MATERIAL/FINISH

- Malleable iron/Zinc plated

CERTIFICATIONS

- UL Listed*

BEAM CLAMPS

WIDE MOUTH



MBC-14020WM



FEATURES

- Tapped holes on side and bottom

APPLICATION

- Wide-mouth malleable iron beam clamps are used with large flange beams to support conduit hangers, bridle rings and drop rods

MATERIAL/FINISH

- Iron/Zinc plated

CERTIFICATIONS

- UL Listed

| PART # | JAW OPENING | SIDE/BOTTOM THREADED HOLES | STATIC LOAD (LBS.) | BOX QTY. |
|------------|-------------|----------------------------|--------------------|----------|
| MBC-1420WM | 3-1/8" | 1/4"-20 | 450 | 50 |
| MBC-3816WM | 3-1/8" | 3/8"-16 | 1300 | 25 |
| MBC-1213WM | 3-1/8" | 1/2"-13 | 1700 | 10 |

HEAVY-DUTY BODY, MALLEABLE IRON



MBC-1024



FEATURES

- Tapped holes on side and bottom

APPLICATION

- Malleable iron beam clamps are used to support conduit hangers, bridle rings and drop rods

MATERIAL/FINISH

- Malleable iron/Zinc plated

CERTIFICATIONS

- UL Listed

| PART # | JAW OPENING | HOLE THREAD | STATIC LOAD (LBS.) | BOX QTY. |
|------------|-------------|-------------|--------------------|----------|
| MBC-1213XL | 31/32" | 1/2"-13 | 1700 | 50 |
| MBC-1024 | 7/8" | 10"-24 | 375 | 100 |

HANGING AND SUPPORT

UNIVERSAL BEAM CLAMP

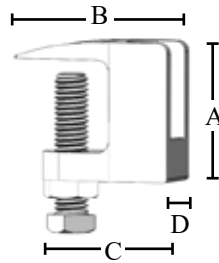

3000037EGTZ



| PART # | FLANGE THICKNESS | ROD SIZE | MOUNT LOAD (LBS.) | BOX QTY. | A | B | C | D |
|-------------|------------------|----------|-------------------|----------|-------|-------|-------|------|
| 3000037EGTZ | 3/4" | 3/8" | 300 | 100 | 1.60" | 1.88" | 1.79" | .792 |
| 3000050EGTZ | 3/4" | 1/2" | 300 | 100 | 1.64" | 1.70" | 1.78" | 1.04 |
| 3000062EGTZ | 3/4" | 5/8" | 300 | 50 | 1.85" | 1.84" | 1.82" | 1.18 |
| 3000075EGTZ | 3/4" | 3/4" | 300 | 50 | 1.87" | 2.29" | 2.12" | 1.31 |
| 3100037EGTZ | 1-1/4" | 3/8" | 300 | 50 | 2.03" | 1.67" | 2.31" | .948 |
| 3100050EGTZ | 1-1/4" | 1/2" | 300 | 50 | 2.10" | 1.67" | 2.33" | 1.02 |

FEATURES

- Electrogalvanized coating for corrosion protection
- Threaded rod attaches vertically from back of clamp

APPLICATION

- Provides a connection point for threaded rods or bridle rings from beam flange

MATERIAL/FINISH

- Steel/Galvanized

CERTIFICATIONS

- UL Standard: UL 2239



BEAM CLAMP, REVERSIBLE

MALLEABLE IRON



3000037PLTZ



| PART # | JAW OPENING | ROD SIZE | STATIC LOAD (LBS.) | | BOX QTY. |
|---------------|-------------|-----------|--------------------|--------------|----------|
| | | | TOP MOUNT | BOTTOM MOUNT | |
| 3000037PLTZ** | 3/4" | 3/8" | 300 | --- | 100 |
| MFC-5811* | 1-3/8" | 5/8" – 11 | 750 | 400 | 25 |
| MFC-3410* | 1-3/8" | 3/4" – 10 | 1000 | 600 | 25 |

* UL listed | ** cULus listed

FEATURES

- Through-hole in beam clamps allows drop rod length adjustment
- Hardened cup point set screws come with jam nuts to prevent vibratory loosening in industrial settings

APPLICATION

- Reversible beam clamps are used when drop rod length needs to be adjusted to accommodate the field installation finished height

MATERIAL/FINISH

- Malleable iron/Unfinished (black)

CERTIFICATIONS

- UL Listed or cULus listed



LIGHT DUTY BEAM CLAMP, REVERSIBLE

MALLEABLE IRON



JFC-1420



FEATURES

- Through-hole in beam clamps allows drop rod length adjustment
- Hardened cup point set screws come with jam nuts to prevent vibratory loosening in industrial settings

APPLICATION

- Reversible beam clamps are used when drop rod length needs to be adjusted to accommodate the field installation finished height

MATERIAL/FINISH

- Malleable iron/Zinc plated

CERTIFICATIONS

- UL Listed

| PART # | JAW OPENING | HOLE THREAD | STATIC LOAD (LBS.) | | BOX QTY. |
|----------|-------------|-------------|--------------------|--------------|----------|
| | | | TOP MOUNT | BOTTOM MOUNT | |
| JFC-1420 | 3/4" | 1/4" - 20 | 250 | 100 | 50 |
| JFC-3816 | 3/4" | 3/8" - 16 | 500 | 250 | 25 |
| JFC-1213 | 3/4" | 1/2" - 13 | 500 | 250 | 25 |
| JFC-5811 | 7/8" | 5/8" - 11 | 750 | 400 | 25 |

BEAM CLAMP/ROD-HANGER



SCC-3816

FEATURES

- Formed steel construction

APPLICATION

- C-style rod hanger clamps are used as structural attachments to metal beams, purlins, channels and angle irons to support boxes, enclosures and fixtures from threaded rods

MATERIAL/FINISH

- Steel/Electroplated zinc or 304 Stainless steel

| PART # | MATERIAL | JAW OPENING | STATIC LOAD (LBS.) | | BOX QTY. |
|-----------|--------------------------|-------------|--------------------|--------------|----------|
| | | | TOP MOUNT | BOTTOM MOUNT | |
| SCC-3816 | ZINC PLATED STEEL | 3/4 | 3/8"-1 | 25 | |
| SCC-1213 | | 3/4 | 1/2"-1 | 25 | |
| SCC-5811 | | 3/4 | 5/8"-1 | | |
| SCC-3410 | | 3/4 | 3/4"-1 | 25 | |
| SCC-3816S | 304 STAINLESS STEEL | 3/4 | 3/8"-1 | | |
| SCC-1213S | | 3/4 | 1/2"-1 | 25 | |
| SCC-5811S | | 3/4 | 5/8"-1 | | |
| SCC-3410S | | 3/4 | 3/4"-1 | 25 | |
| SCC-3816B | UNFINISHED (BLACK) STEEL | 3/4 | 3/8"-1 | 25 | |
| SCC-1213B | | 3/4 | 1/2"-1 | 25 | |
| SCC-5811B | | 3/4 | 5/8"-1 | | |
| SCC-3410B | | 3/4 | 3/4"-1 | 25 | |



BEAM CLAMP/ROD-HANGER

MALLEABLE IRON



MCC-3816

FEATURES

- For vertical loads

APPLICATION

- C-style rod hanger clamps are used as structural attachments to metal beams, purlins, channels and angle irons to support boxes, enclosures and fixtures from threaded rods

MATERIAL/FINISH

- Malleable iron/Zinc plated or unfinished

| PART # | MATERIAL | JAW OPENING | HOLE THREAD | BOX QTY. |
|------------|-------------------------|-------------|-------------|----------|
| MCC-3816 | ZINC PLATED IRON | 3/4" | 3/8"-16 | 25 |
| MCC-1213 | | 3/4" | 1/2"-13 | 25 |
| MCC-5811 | | 3/4" | 5/8"-11 | 25 |
| MCC-3410 | | 3/4" | 3/4"-10 | 25 |
| MCC-3816BK | UNFINISHED (BLACK) IRON | 3/4" | 3/8"-16 | 25 |
| MCC-1213BK | | 3/4" | 1/2"-13 | 25 |
| MCC-5811BK | | 3/4" | 5/8"-11 | 25 |
| MCC-3410BK | | 3/4" | 3/4"-10 | 25 |



BEAM CLAMP

PARALLEL EDGE



1561HDG

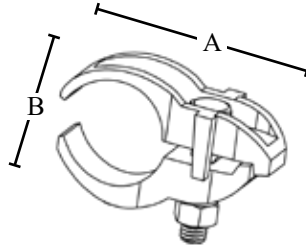

FEATURES

- Hot dip galvanized over malleable iron for added durability and corrosion protection

APPLICATION

- Parallel beam conduit clamps are used to mount EMT, rigid, or IMC conduit parallel to beam, channel and angle supports

MATERIAL/FINISH

- Malleable iron/Hot dip galvanized

CERTIFICATIONS

- UL Listed: UL Standard 2239

| PART # | SIZE | BOX QTY. | A | B |
|---------|--------|----------|-------|-------|
| 1561HDG | 1/2" | 50 | 2.80" | 1.42" |
| 1562HDG | 3/4" | 50 | 2.99" | 1.47" |
| 1563HDG | 1" | 50 | 3.19" | 1.54" |
| 1564HDG | 1-1/4" | 25 | 3.39" | 2.01" |
| 1565HDG | 1-1/2" | 25 | 3.62" | 2.01" |
| 1566HDG | 2" | 25 | 4.37" | 2.87" |
| 1567HDG | 2-1/2" | 10 | 5.12" | 3.23" |
| 1568HDG | 3" | 10 | 5.79" | 4.06" |
| 1569HDG | 3-1/2" | 10 | 6.26" | 4.53" |
| 350-P | 4" | 10 | 6.46" | 4.61" |

CROSS BEAM EDGE



1571HDG

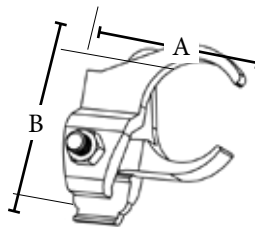

FEATURES

- Malleable iron construction

APPLICATION

- Beam edge conduit clamps are used to mount EMT or rigid conduit perpendicular to beam, channel and angle supports

MATERIAL/FINISH

- Malleable iron/Hot dip galvanized

| PART # | SIZE | BOX QTY. | A | B |
|---------|--------|----------|-------|-------|
| 1571HDG | 1/2" | 50 | 2.10" | 2.72" |
| 1572HDG | 3/4" | 50 | 2.44" | 3.01" |
| 1573HDG | 1" | 50 | 2.57" | 3.23" |
| 1574HDG | 1-1/4" | 25 | 2.96" | 3.47" |
| 1575HDG | 1-1/2" | 25 | 3.27" | 3.65" |
| 1576HDG | 2" | 25 | 3.85" | 4.36" |
| 1577HDG | 2-1/2" | 10 | 4.40" | 5.05" |
| 1578HDG | 3" | 10 | 5.08" | 5.41" |

BEAM CLAMP

J-STYLE UNDER BEAM



JCL50

| PART # | SIZE | BOX QTY. |
|-----------|--------|----------|
| JCL50 | 1/2" | 50 |
| JCL75 | 3/4" | 50 |
| JCL100 | 1" | 25 |
| JCL125 | 1-1/4" | 25 |
| JCL150 | 1-1/2" | 25 |
| JCL250 | 2-1/2" | 5 |
| JCL350300 | 3-1/2" | 1 |

FEATURES

- Zinc plated malleable iron construction provides a secure and durable connection

APPLICATION

- J-style conduit beam clamps are used with metallic and flexible conduit
- Clamp allows conduit to be clamped to the parallel or perpendicular 90° to the beam

MATERIAL/FINISH

- Malleable iron/Zinc plated



RIGHT ANGLE UNDER BEAM - MALLEABLE IRON



1551HDG

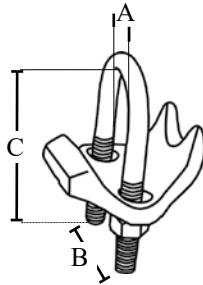

FEATURES

- Hot dip galvanized over malleable iron for added durability and corrosion protection

APPLICATION

- Right angle conduit clamps are used to mount EMT or rigid conduit across, parallel, or perpendicular to beam, channel or angle supports

MATERIAL/FINISH

- Malleable iron/Hot dip galvanized

CERTIFICATIONS

- UL Listed

| PART # | SIZE | BOX QTY. | A | B | C |
|----------|--------|----------|-------|-------|-------|
| 1551HDG | 1/2" | 50 | .97" | 1.24" | 2.46" |
| 1552HDG | 3/4" | 50 | 1.15" | 1.43" | 2.76" |
| 1553HDG | 1" | 50 | 1.42" | 1.70" | 3.01" |
| 1554HDG | 1-1/4" | 50 | 1.79" | 2.07" | 3.16" |
| 1555HDG | 1-1/2" | 50 | 2.04" | 2.32" | 3.52" |
| 1556HDG | 2" | 50 | 2.49" | 2.83" | 4.39" |
| 1557HDG | 2-1/2" | 25 | 3.06" | 3.39" | 4.75" |
| 1558HDG | 3" | 25 | 3.65" | 3.98" | 5.38" |
| 1559HDG | 3-1/2" | 25 | 4.21" | 4.55" | 5.76" |
| 1559AHDG | 4" | 25 | 4.69" | 5.03" | 6.27" |

THREADED ANGLE ROD BRACKET



6TIBTZ

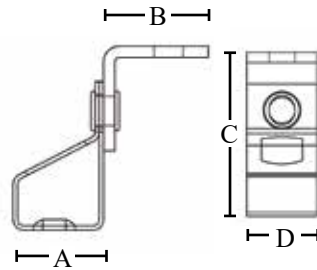

FEATURES

- Rotatable joint ensures rod maintains a vertical position
- Galvanized bracket

APPLICATION

- Mounts to wood or concrete structures to suspend threaded rods

MATERIAL/FINISH

- Spring Steel/GEOSEAL™

CERTIFICATIONS

- UL Standard: UL 2239



| PART # | THREAD SIZE | STATIC LOAD (LBS.) | BOX QTY. | A | B | C | D |
|--------|-------------|--------------------|----------|------|-------|-------|-------|
| 4TIBTZ | 1/4" | 160 | 100 | .85" | .984" | 1.70" | .748" |
| 6TIBTZ | 3/8" | 160 | 100 | .85" | .984" | 1.70" | .748" |

Load limits are for fasteners only. Attachment to structure must be evaluated separately

WALL MOUNT, THREADED ROD HANGER



R014T

FEATURES

- Design allows threaded rods to be added quickly and easily to any overhead structure

APPLICATION

- Threaded rod support brackets are used to suspend #8 wires, and 1/4" plain or threaded rods from wood or metal overhead structures

MATERIAL/FINISH

- Black oxide/Zinc plated steel

| PART # | FOR ROD SIZE | BOX QTY. |
|--------|--------------|----------|
| R014T | 1/4" – 20 | 100 |
| R038T | 3/8" – 16 | 100 |

QUICK SHOT, THREADED HANGER CLIPS



TRH-1420

| PART # | SIZE | BOX QTY. |
|----------|-----------|----------|
| TRH-1420 | 1/4" – 20 | 100 |
| TRH-3816 | 3/8" – 16 | 100 |

FEATURES

- Included pre-set concrete nail

APPLICATION

- Quick shot threaded rod hanger is used to suspend all threaded rods quickly and easily to any overhead structure

QUICK SHOT, THREADED ROD COUPLER HANGER



STF14

| PART # | DESCRIPTION | SIZE | BOX QTY. |
|--------|---|-----------|----------|
| STF14 | PRE-ASSEMBLED WITH CONCRETE NAIL AND WASHER | 1/4" – 20 | 6" |

FEATURES

- Quickly installs with most powder actuated guns (similar to Ramset)
- Pre-assembled with concrete nail and washer
- Included threaded coupler to easily attach any length 1/4" – 20 all threaded rod

APPLICATION

- Use to install overhead all threaded rod support in concrete, masonry or metal ceiling applications

WITH SLOCK ROD ASSEMBLY



STF0030

FEATURES

- Included pre-set concrete nail

APPLICATION

- Quick shot threaded rod hanger is used to suspend all threaded rods quickly and easily to any overhead structure

| PART # | DESCRIPTION | DROP ROD THREAD | OVERALL LENGTH | BOX QTY. |
|---------|---|---------------------------|----------------|----------|
| STF0030 | PRE-ASSEMBLED WITH CONCRETE NAIL AND WASHER | 1/4" DIAMETER, NO THREADS | 30" | 50 |
| STF0036 | | 1/4" DIAMETER, NO THREADS | 36" | 50 |



QUICK SHOT, THREADED ROD COUPLER HANGER WITH ALL THREADED ROD ASSEMBLY



STF1424

FEATURES

- Pre-assembled with concrete nail and washer
- Two 1/4" mounting hex nuts included
- Will shoot into metal, concrete or masonry using standard power actuated gun (similar to Ramset)

APPLICATION

- Use to install all threaded rod overhead support in concrete, masonry or metal ceiling applications
- All threaded rod included with hanger
- Use to mount and support many electrical boxes, enclosures and lighting fixtures

| PART # | DESCRIPTION | DROP ROD THREAD | OVERALL LENGTH | BOX QTY. |
|---------|---|-----------------|----------------|----------|
| STF1424 | PRE-ASSEMBLED WITH CONCRETE NAIL AND WASHER | 1/4" - 20 | 24" | 50 |
| STF1430 | | | 30" | 50 |
| STF1436 | | | 36" | 50 |
| STF1448 | | | 48" | 50 |

QUICK SCREW, THREADED ROD COUPLER



STF14NP

FEATURES

- .74" mounting hole

APPLICATION

- Screw mount angled mounting couplers allows all threaded rod length to be quickly and easily affixed to any overhead surface (mounting hardware not included)

MATERIAL/FINISH

- Steel/Galvanized

| PART # | INCLUDED COUPLER THREAD | OVERALL LENGTH | BOX QTY. |
|---------|-------------------------|----------------|----------|
| STF14NP | 1/4" - 20 | 6" | 50 |

THREADED ROD BRACKET

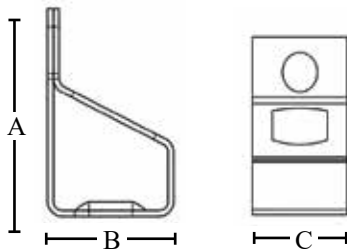

6TITZ



FEATURES

- 1/4" plain mounting hole

APPLICATION

- Mounts to wood or concrete structures to suspend threaded rods or wire

MATERIAL/FINISH

- Spring Steel/GEOSEAL™

CERTIFICATIONS

- UL Standard: UL 2239

| PART # | THREAD SIZE | STATIC LOAD (LBS.) | A | B | C | BOX QTY. |
|--------|---------------|--------------------|-------|------|-------|----------|
| 4TITZ | 1/4" THREADED | 160 | 1.40" | .85" | .748" | 100 |
| 6TTZ | 3/8" PLAIN | 160 | 1.40" | .85" | .748" | 100 |
| 6TITZ | 3/8" THREADED | 160 | 1.40" | .85" | .748" | 100 |

Load limits are for fasteners only. Attachment to structure must be evaluated separately.



MULTI-FUNCTION CLIPS



4Z34TZ

4Z4STZ

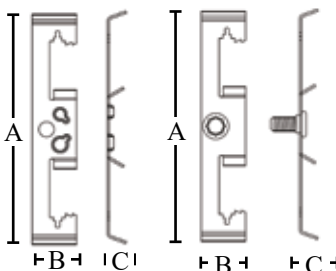

FEATURES

- Supports #10-24 and 1/4"-20 Bridle rings
- Spring steel tightening feature secures clip without addition hardware
- Use with other Southwire fasteners to create multiple cable and conduit support solutions

APPLICATION

- Easily installs on flanges, rods, and wire to support boxes or conduit

MATERIAL/FINISH

- Spring Steel/GEOSEAL™

CERTIFICATIONS

- UL Standard: UL 2239

| PART # | FLANGE THICKNESS | ROD SIZE | WIRE SIZE | HOLE SIZE | SCREW SIZE | LOAD CAPACITY (LBS.) | | A | B | C | BOX QTY. |
|--------|------------------|----------|-----------|-----------|------------|----------------------|------------|-------|-------|-------|----------|
| | | | | | | VERTICAL | HORIZONTAL | | | | |
| 4Z34TZ | 1/8" – 3/8" | 1/4" | #12 – #8 | 1/4" | NONE | 25 | 15 | 3.87" | .748" | .315" | 100 |
| 4Z4STZ | 1/8" – 3/8" | 1/4" | #12 – #8 | --- | 1/4" – 20 | 25 | 15 | 3.87" | .748" | .315" | 100 |
| 6Z34TZ | 3/8" – 7/16" | 3/8" | --- | 1/4" | NONE | 25 | 15 | 3.62" | .748" | .315" | 100 |

FASTENERS/ HARDWARE



METAL STUD GROMMETS



ESG1TZ

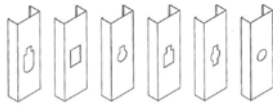

Common hole configurations in metal studs

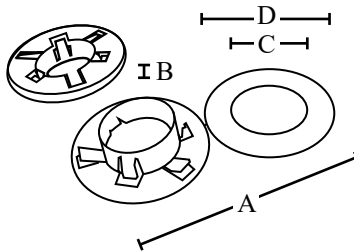

| PART # | BOX QTY. | A | B | C | D |
|---------|----------|-------|------|-------|-------|
| ESG1TZ | 100 | 4.61" | .56" | 1.35" | 2.27" |
| ESG1MTZ | 1000 | 4.61" | .56" | 1.35" | 2.27" |

FEATURES

- Tool free installation
- Provides 360° protection for cables
- Makes pulling cables easier
- Fits all stud hole sizes
- Snaps in over different hole configurations for protection from sharp metal

APPLICATION

- Universal metal stud grommets are used to protect wires from damage caused by sharp edges on metal studs

MATERIAL/FINISH

- 6/6 Nylon

CERTIFICATIONS

- UL Standard: UL514B



WIRETAB™ CABLE POSITIONING DEVICE



MWT1

| PART # | TRADE SIZE | BOX QTY. |
|--------|------------|----------|
| MWT1 | 1 GANG | 25 |

APPLICATION

- Hold loose end of wire in position during construction.
- Ideal for under cabinet lights, security, doorbells, speakers and more

FEATURES

- WireTab™ Cable Positioning Device hugs the corner of a wall stud, allowing loose wire ends to be threaded through the channel
- When drywall is hung, a pre-cut hole is positioned to surround the WireTab™ Cable Positioning Device channel so wire ends are in the correct place

MATERIAL/FINISH

- Polyethylene/Yellow

END CAPS FOR STRUT CHANNEL



SFEC08

APPLICATION

- To cap off end of strut channel

MATERIAL/FINISH

- White Plastic

| PART # | FOR CHANNEL | BOX QTY. |
|--------|-----------------|----------|
| SFEC08 | 13/16" X 1-5/8" | 100 |
| SFEC09 | 1-5/8" X 1-5/8" | 100 |

FLAT SPLICE PLATES

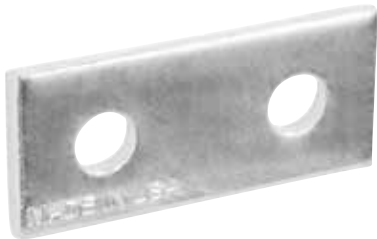

SFF30

FEATURES

- 1/4" thick steel

APPLICATION

- Use to secure two pieces of strut channel together
- SFF34 is used for parallel/side by side strut attachment

MATERIAL/FINISH

- Steel/Electroplated zinc

| PART # | NUMBER OF HOLES | TYPE | BOX QTY. |
|--------|-----------------|-----------------|----------|
| SFF30 | 2 | END SPLICE | 50 |
| SFF31 | 3 | END SPLICE | 25 |
| SFF32 | 4 | END SPLICE | 25 |
| SFF34 | 2 | PARALLEL SPLICE | 25 |

3 HOLE FLAT SPLICE PLATES CORNER



SFF50

FEATURES

- 1/4" thick steel

APPLICATION

- Use to secure two pieces of strut channel at a 90° angle

MATERIAL/FINISH

- Steel/Green powder coat or Electroplated zinc

| PART # | HOLE DIAMETER | HOLE CENTER TO CENTER | FINISH | BOX QTY. |
|----------|---------------|-----------------------|-------------------|----------|
| SFF50-GN | 9/16" | 1-7/8" | GREEN POWDER COAT | 25 |
| SFF50 | 9/16" | 1-7/8" | ZINC PLATED | 25 |

4 HOLE FLAT SPLICE PLATES CORNER



SFF51-GN

FEATURES

- 1/4" thick steel

APPLICATION

- Use to secure two pieces of strut channel at a 90° angle

MATERIAL/FINISH

- Steel/Green powder coat or Electroplated zinc

| PART # | HOLE DIAMETER | HOLE CENTER TO CENTER | FINISH | BOX QTY. |
|----------|---------------|-----------------------|-------------------|----------|
| SFF51-GN | 9/16" | 1-7/8" | GREEN POWDER COAT | 20 |
| SFF51 | 9/16" | 1-7/8" | ZINC PLATED | 20 |

4 HOLE FLAT SPLICE PLATES TEE

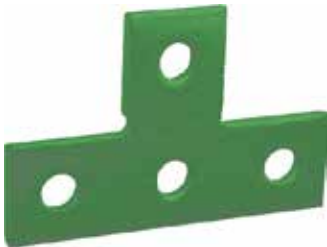

SFF60-GN

FEATURES

- 1/4" thick steel

APPLICATION

- Use to secure two pieces of strut channel at a 90° angle

MATERIAL/FINISH

- Steel/Green powder coat or Electroplated zinc

| PART # | HOLE DIAMETER | HOLE CENTER TO CENTER | FINISH | BOX QTY. |
|----------|---------------|-----------------------|-------------------|----------|
| SFF60-GN | 9/16" | 1-7/8" | GREEN POWDER COAT | 20 |
| SFF60 | 9/16" | 1-7/8" | ZINC PLATED | 20 |

2 HOLE 90° ANGLE CORNER BRACKET



SFL11-GN

FEATURES

- Legs: 2" x 1-7/8" * 1/4" thick steel

APPLICATION

- Use to secure two pieces of strut channel at a 90° angle

MATERIAL/FINISH

- Steel/Green powder coat, Electroplated zinc, or 316 Stainless steel

| PART # | HOLE DIAMETER | MATERIAL | FINISH | BOX QTY. |
|----------|---------------|---------------------|-------------------|----------|
| SFL11-GN | 9/16" | STEEL | GREEN POWDER COAT | 50 |
| SFL11 | 9/16" | STEEL | ZINC PLATED | 50 |
| SFL11-SS | 9/16" | 316 STAINLESS STEEL | STAINLESS | 50 |

TWO HOLE ANGLE BRACKET



ABTZ

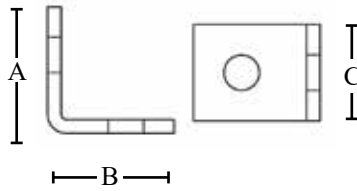

FEATURES

- 1/4" structural mounting hole

APPLICATION

- Provides attachment of rods, hooks, or chains from concrete or wood structure

MATERIAL/FINISH

- Steel/Galvanized or Stainless steel

CERTIFICATIONS

- UL Standard: UL 2239



| PART # | MATERIAL | ROD SIZE | THROUGH HOLE SIZE | | BOX QTY. | A | B | C |
|-----------|------------------|----------|-------------------|------------|----------|-------|-------|-------|
| | | | SMALL HOLE | LARGE HOLE | | | | |
| ABTZ | STEEL/GALVANIZED | 1/4" | .250" | .250" | 100 | .984" | .984" | .748" |
| AB375TZ | | 3/8" | .280" | .280" | 100 | .984" | .984" | .748" |
| BA-1/4-SS | STAINLESS STEEL | 1/4" | .250" | .385" | 100 | .984" | .984" | .748" |
| BA-3/8-SS | | 3/8" | .280" | .385" | 100 | .984" | .984" | .748" |

TWO HOLE 90° ANGLE CROSS CORNER BRACKET



SFL20

FEATURES

- Legs: 2-1/4" x 1-5/8"
- 1/4" thick steel

APPLICATION

- Use to secure three pieces of strut channel at a 90° angle X

MATERIAL/FINISH

- Steel/Electroplated zinc

| PART # | HOLE DIAMETER | FINISH | BOX QTY. |
|--------|---------------|-------------|----------|
| SFL20 | 9/16" | ZINC PLATED | 50 |

THREE HOLE 90° ANGLE CORNER BRACKET



SFL21

FEATURES

- Legs: 4-1/8" x 1-5/8"
- 1/4" thick steel

APPLICATION

- Use to secure two pieces of strut channel at a 90° angle

MATERIAL/FINISH

- Steel/Electroplated zinc

| PART # | HOLE DIAMETER | FINISH | BOX QTY. |
|--------|---------------|-------------|----------|
| SFL21 | 9/16" | ZINC PLATED | 25 |

FOUR HOLE 90° ANGLE CORNER BRACKET



L220000EGTZ



FEATURES

- Legs: 4-1/8" x 3-1/2"
- 1/4" thick steel

APPLICATION

- Use to secure two pieces of strut channel at a 90° angle

MATERIAL/FINISH:

- Steel/Galvanized or 316 Stainless steel

| PART # | MATERIAL | HOLE DIAMETER | BOX QTY. |
|-------------|---|---------------|----------|
| L220000EGTZ | STEEL/GALVANIZED 316 STAINLESS STEEL | 9/16" | 25 |
| SFL31-SS | 316 STAINLESS STEEL | 9/16" | 25 |

FOUR HOLE CORNER 90° ANGLE BRACKET



SFL13-GN

| PART # | HOLE DIAMETER | MATERIAL | FINISH | BOX QTY. |
|----------|---------------|----------|-------------------|----------|
| SFL13-GN | 9/16" | STEEL | GREEN POWDER COAT | 25 |
| SFL13 | 9/16" | STEEL | ZINC PLATED | 25 |

FEATURES

- Legs: 3-7/8" x 3-3/4"
- 1/4" thick steel

APPLICATION

- Use to secure two pieces of strut channel at a 90° angle

MATERIAL/FINISH

- Steel/Green powder coat, Electroplated zinc, or 316 Stainless steel

THREE HOLE CORNER 90° ANGLE BRACKET



SFL30

| PART # | HOLE DIAMETER | FINISH | BOX QTY. |
|--------|---------------|-------------|----------|
| SFL30 | 9/16" | ZINC PLATED | 25 |

FEATURES

- Legs: 3-1/2" x 2-1/4"
- 1/4" thick steel

APPLICATION

- Use to secure two pieces of strut channel at a 90° angle

MATERIAL/FINISH

- Steel/Electroplated zinc

TWO HOLE CORNER 45° ANGLE BRACKET



SFL60

FEATURES

- 1/4" thick steel

APPLICATION

- Use to secure two pieces of strut channel at a 45° angle

MATERIAL/FINISH

- Steel/Green powder coat or Electroplated zinc

| PART # | HOLE DIAMETER | FINISH | BOX QTY. |
|----------|---------------|-------------------|----------|
| SFL60-GN | 9/16" | GREEN POWDER COAT | 25 |
| SFL60 | 9/16" | ZINC PLATED | 25 |

FOUR HOLE CORNER 45° ANGLE BRACKET



SFL62

FEATURES

- 1/4" thick steel

APPLICATION

- Use to secure two pieces of strut channel at a 45° angle

MATERIAL/FINISH

- Steel/Electroplated zinc

| PART # | HOLE DIAMETER | FINISH | BOX QTY. |
|--------|---------------|-------------|----------|
| SFL62 | 9/16" | ZINC PLATED | 25 |

U-FITTING SPLICE

EXTERNAL, FOUR HOLE



SFU33-GN

FEATURES

- 1/4" thick steel

APPLICATION

- Use to secure two pieces of strut channel

MATERIAL/FINISH

- Steel/Green powder coat or Electroplated zinc

| PART # | FOR CHANNEL DEPTH | HOLE DIAMETER | LENGTH | FINISH | BOX QTY. |
|----------|-------------------|---------------|--------|-------------------|----------|
| SFU33-GN | 13/16" | 9/16" | 7-1/4" | GREEN POWDER COAT | 10 |
| SFU33 | 13/16" | 9/16" | 7-1/4" | ZINC PLATED | 10 |
| SFU32-GN | 1-5/8" | 9/16" | 7-1/4" | GREEN POWDER COAT | 10 |
| SFU32 | 1-5/8" | 9/16" | 7-1/4" | ZINC PLATED | 10 |

STRUT JOINER INTERNAL

WITH CAM SCREWS



SFEF33-1316

APPLICATION

- Use to secure two pieces of strut channel

MATERIAL/FINISH

- Steel/Electroplated zinc

| PART # | FOR CHANNEL DEPTH | LENGTH | FINISH | BOX QTY. |
|-------------|-------------------|---------|-------------|----------|
| SFEF33-1316 | 13/16" | 4-7/16" | ZINC PLATED | 10 |
| SFEF33-158 | 1-5/8" | 4-7/16" | ZINC PLATED | 10 |

WALL BRACKET CHANNEL

FOR 1-5/8" STRUT



SFBR40-6

FEATURES

- 1/4" thick steel

APPLICATION

- Use as shelf or to hang other apparatuses

MATERIAL/FINISH

- Steel/Electroplated zinc

| PART # | DESCRIPTION | LENGTH | UNIFORM LOAD CAPACITY (LBS.) | BOX QTY. |
|-----------|------------------|--------|------------------------------|----------|
| SFBR40-6 | 2 MOUNTING HOLES | 6" | 1,250 | 1 |
| SFBR40-9 | 3 MOUNTING HOLES | 9" | 1,000 | 1 |
| SFBR40-12 | 4 MOUNTING HOLES | 12" | 750 | 1 |

TWO HOLE POST BASE

6" X 4"



SFP10

FEATURES

- 1/4" thick steel

APPLICATION

- Use to secure strut channel to floor or flat surface

MATERIAL/FINISH

- Steel/Electroplated zinc

| PART # | DESCRIPTION | CHANNEL SIZE | FINISH | BOX QTY. |
|--------|------------------|--------------|-------------|----------|
| SFP10 | PARALLEL TO EDGE | 1-5/8" | ZINC PLATED | 5 |

FOUR HOLE POST BASE

6" X 6"



SFP14-GN

FEATURES

- 1/4" thick steel

APPLICATION

- Use to secure strut channel to floor or flat surface

MATERIAL/FINISH

- Steel/Green powder coat or Electroplated zinc

| PART # | DESCRIPTION | CHANNEL SIZE | FINISH | BOX QTY. |
|----------|--------------------|--------------|-------------------|----------|
| SFP14-GN | PARALLEL TO EDGE | 1-5/8" | GREEN POWDER COAT | 5 |
| SFP14 | PARALLEL TO EDGE | 1-5/8" | ZINC PLATED | 5 |
| SFP13 | TURNED 45° TO EDGE | 1-5/8" | ZINC PLATED | 5 |

RMC U-BOLT WITH HEX NUTS

HOT DIP GALVANIZED



761HDG

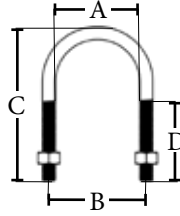

FEATURES

- Hot dip galvanized zinc plating over malleable iron for added durability and corrosion protection

APPLICATION

- U-Bolts secure conduit to a beam or channel

MATERIAL/FINISH

- Malleable iron/Hot dip galvanized

| PART # | SIZE | BOLT SIZE | INNER QTY. | MASTER QTY. | A | B | C | D |
|--------|--------|------------|------------|-------------|-------|-------|-------|-------|
| 761HDG | 1/2" | 5/16" - 18 | 25 | 250 | .97" | 1.24" | 2.46" | 1.50" |
| 762HDG | 3/4" | 5/16" - 18 | 25 | 250 | 1.15" | 1.43" | 2.76" | 1.50" |
| 763HDG | 1" | 5/16" - 18 | 25 | 250 | 1.42" | 1.70" | 3.01" | 1.50" |
| 764HDG | 1-1/4" | 5/16" - 18 | 20 | 200 | 1.79" | 2.07" | 3.16" | 1.50" |
| 765HDG | 1-1/2" | 5/16" - 18 | 20 | 200 | 2.04" | 2.32" | 3.52" | 1.50" |
| 766HDG | 2" | 3/8" - 16 | 10 | 100 | 2.49" | 2.83" | 4.39" | 1.96" |
| 767HDG | 2-1/2" | 3/8" - 16 | --- | 20 | 3.06" | 3.39" | 4.75" | 1.96" |
| 768HDG | 3" | 3/8" - 16 | --- | 20 | 3.65" | 3.98" | 5.38" | 1.96" |
| 769HDG | 3-1/2" | 3/8" - 16 | --- | 20 | 4.21" | 4.55" | 5.76" | 1.96" |
| 770HDG | 4" | 3/8" - 16 | --- | 20 | 4.69" | 5.03" | 6.27" | 1.96" |

STRUT TO BEAM CLAMP WITH BOLT



SFBC60

FEATURES

- 3/8" - 16 threads

APPLICATION

- Use to secure strut channel to underside of a beam

MATERIAL/FINISH

- Steel/Electroplated zinc

| PART # | FOR HEIGHT CHANNEL | MAX FLANGE THICKNESS | MAX LOAD (LBS.) USED IN PAIRS | BOX QTY. |
|--------|--------------------|----------------------|-------------------------------|----------|
| SFBC60 | 13/16" OR 1-5/8" | 3/4" | 1,200 | 25 |
| SFBC61 | 2-7/16" OR 3-1/4" | 3/4" | 1,200 | 25 |

STRUT TO BEAM WINDOW CLAMP

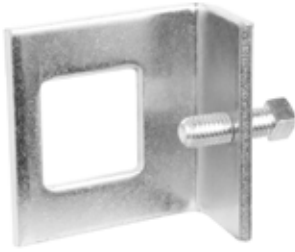

SFBC40

FEATURES

- 1/4" thick steel

APPLICATION

- Use to secure strut channel to floor or flat surface

MATERIAL/FINISH

- Steel/Electroplated zinc

| PART # | FOR CHANNEL | MAX LOAD (LBS.) USED IN PAIRS | MATERIAL | BOX QTY. |
|--------|-----------------|-------------------------------|-------------------|----------|
| SFBC40 | 1-5/8" X 1-5/8" | 950 | ZINC PLATED STEEL | 20 |

STRUT TO BEAM NOTCHED CLAMP



SFBC70

FEATURES

- 1/4" thick steel
- 1/2"-13 HHCS and 1/2" channel nut sold separately

APPLICATION

- Use to secure strut channel to the underside of a structural beam in tight spaces
- Use in conjunction with spring nuts or cone nuts to securely fasten the strut to the beam surface

MATERIAL/FINISH

- Steel/Electroplated zinc

| PART # | FOR CHANNEL | MAX LOAD (LBS.) USED IN PAIRS | BOX QTY. |
|--------|-----------------|-------------------------------|----------|
| SFBC70 | 13/16" X 1-5/8" | 1,100 | 25 |

BAR-JOIST WASHERS



23WBJ

APPLICATION

- Bar joist washers clamp on open web bar joist trusses and allow for multiple items to be hung along ceiling joists
- Bar joist washers allow the installer to easily mount boxes, hangers and clamps anywhere along linear open bar joist grid

MATERIAL/FINISH

- Steel/Electroplated zinc

| PART # | FOR ROD OR BOLT SIZE | BOX QTY. |
|--------|----------------------|----------|
| 23WBJ | 1/4" | 50 |
| 24WBJ | 3/8" | 50 |

SWIVEL, MALE/FEMALE



SFSW13-3816

| PART # | THREAD | MAX LOAD CAPACITY (LBS.) | BOX QTY. |
|-------------|-----------|--------------------------|----------|
| SFSW13-3816 | 3/8" – 16 | 620 | 50 |
| SFSW13-1213 | 1/2" – 13 | 1,150 | 50 |

FEATURES

- Allows for straight, flush hang

APPLICATION

- Use as a union between two supports or pieces of all threaded rod

MATERIAL/FINISH

- Steel/Electroplated zinc

SWIVEL, FEMALE/FEMALE



SFSW12-3816

| PART # | THREAD | MAX LOAD CAPACITY (LBS.) | BOX QTY. |
|-------------|-----------|--------------------------|----------|
| SFSW12-3816 | 3/8" – 16 | 620 | 50 |
| SFSW12-1213 | 1/2" – 13 | 1,150 | 50 |

FEATURES

- Allows for straight, flush hang

APPLICATION

- Use as a union between two supports or pieces of all threaded rod

MATERIAL/FINISH

- Steel/Electroplated zinc

THREADED ROD HANGERS



SMY142W



SMY141S

FEATURES

- Direct mount into support surface

APPLICATION

- Threaded rod hangers are specifically designed to be used in overhead applications to provide tapped 1/4"-20 or 3/8"-16 threaded rod attachment points

MATERIAL/FINISH

- Steel/Zinc plated

| PART # | OVERALL LENGTH | APPLICATION | FOR ROD SIZE | BOX QTY. |
|---------|----------------|-------------------|--------------|----------|
| SMY142W | 2" | FOR WOOD | 1/4" - 20 | 10 |
| SMY382W | 2-1/2" | FOR WOOD | 3/8" - 16 | 10 |
| SMY141C | 2" | FOR MASONRY/BRICK | 1/4" - 20 | 10 |
| SMY381C | 2-1/2" | FOR MASONRY/BRICK | 3/8" - 16 | 10 |
| SMY141S | 1" | FOR SHEET METAL | 1/4" - 20 | 10 |
| SMY381S | 1" | FOR SHEET METAL | 3/8" - 16 | 10 |



SLIP-TIGHT THREADED ROD NUT



SLN-3816

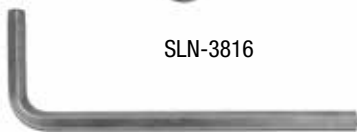

FEATURES

- Secure nut in place with Allen wrench

APPLICATION

- Slip-tight threaded rod nut has ability to be positioned on threaded rod or bolt at any point, without the time consuming nuisance of threading

MATERIAL/FINISH

- Steel/Zinc plated

| PART # | FOR ROD SIZE | BOX QTY. |
|----------|--------------|----------|
| SLN-3816 | 3/8" - 16 | 100 |

SPLIT NUT



SN37TZ

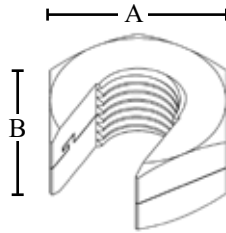

FEATURES

- Allows user to start threading at any point along the threaded rod
- Allows user to avoid damaged threads
- Strong load ratings

APPLICATION

- Southwire's Split Nuts reduce the time for threading a rod compared to conventional nuts

MATERIAL/FINISH

- Steel/Galvanized



| PART # | ROD SIZE | STATIC LOAD (LBS.) | A | B | BOX QTY. |
|--------|----------|--------------------|-------|-------|----------|
| SN37TZ | 3/8" | 42 | .864" | .500" | 100 |
| SN50TZ | 1/2" | 73 | .864" | .500" | 100 |

TOP SPRING NUT



TSNT0037EGTZ

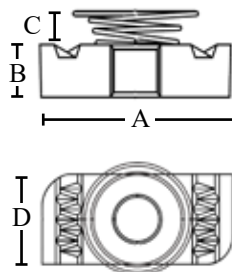

FEATURES

- Spring diameter 1.10"
- Grooved attachment nut creates secure fit and improve traction

APPLICATION

- Manufactured for slip resistant support of components in strut system

MATERIAL/FINISH

- Steel/Galvanized



| PART # | ROD SIZE | CHANNEL SIZE | TORQUE FORCE (LBS.) | BOX QTY. | A | B | C | D |
|--------------|----------|--------------|---------------------|----------|-------|-------|-------|-------|
| TSNT0025EGTZ | 1/4" | 1/4" | 13 | 100 | 1.35" | .208" | .223" | .729" |
| TSNT0037EGTZ | 3/8" | 3/8" | 22 | 100 | 1.36" | .345" | .223" | .75" |

SPRING NUTS WITH SPRING

FOR STRUT CHANNEL



SNSS1420

FEATURES

- No spring for installation flexibility
- Teeth to bit into inside lip of strut

APPLICATION

- Secures fittings or other apparatus to strut system

MATERIAL/FINISH

- Steel/Electroplated zinc

| PART # | FOR CHANNEL DEPTH | HOLE THREAD | BOX QTY. |
|----------|-------------------|-------------|----------|
| SNSS1420 | 13/16" TO 1" | 1/4" - 20 | 50 |
| SNSS3816 | 13/16" TO 1" | 3/8" - 16 | 50 |
| SNSS1213 | 13/16" TO 1" | 1/2" - 13 | 50 |
| 2111 | 1-3/8" TO 1-5/8" | 1/4" - 20 | 100 |
| 2112 | 1-3/8" TO 1-5/8" | 3/8" - 16 | 100 |
| 2113 | 1-3/8" TO 1-5/8" | 1/2" - 13 | 50 |
| SNLS1420 | 2-7/16" TO 3-1/4" | 1/4" - 20 | 50 |
| SNLS3816 | 2-7/16" TO 3-1/4" | 3/8" - 16 | 50 |
| SNLS1213 | 2-7/16" TO 3-1/4" | 1/2" - 13 | 50 |

SELF-TAPPING SCREW



SMS8TZ

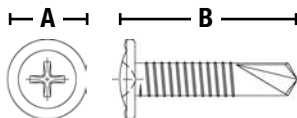

FEATURES

- Self-drilling and tapping
- Low profile Phillips head #8, 1/2"

APPLICATION

- Supports metal box brackets to studs
- Low profile screw head reduces sheet rock bulge

MATERIAL/FINISH

- Steel/Galvanized

| PART # | BOX QTY. | A | B |
|--------|----------|------|------|
| SMS8TZ | 1000 | .414 | .500 |

BOTTOM SPRING NUT



SPRA0037EGTZ

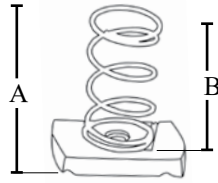

FEATURES

- Grooved attachment nut creates secure fit and improves traction
- For use with 1-5/8" strut channel

APPLICATION

- Manufactured for slip resistant support of components in strut system

MATERIAL/FINISH

- Steel/Galvanized

| PART # | CHANNEL TYPE | ROD SIZE | TORQUE FORCE (LBS.) | NUT THICKNESS |
|--------------|--------------|-----------|---------------------|---------------|
| SPRA0025EGTZ | A & B | 1/4" - 20 | 13 | .21" |
| SPRA0037EGTZ | A & B | 3/8" - 16 | 22 | .34" |
| SPRA0050EGTZ | A & B | 1/2" - 13 | 40 | .449" |
| SPRC0025EGTZ | C | 1/4" - 20 | 13 | .222" |

| PART # | BOX QTY. | A | B | C | D |
|--------------|----------|-------|-------|-------|-------|
| SPRA0025EGTZ | 100 | 1.79" | 1.58" | 1.35" | .741" |
| SPRA0037EGTZ | 100 | 1.95" | 1.61" | 1.35" | .72" |
| SPRA0050EGTZ | 100 | 2.02" | 1.57" | 1.34" | .747" |
| SPRC0025EGTZ | 100 | 1" | .778" | 1.35" | .73" |



STRUT NUT, NO SPRING

FOR STRUT CHANNEL



CNN-038



FEATURES

- Teeth to bite into inside lip of strut

APPLICATION

- Secures fittings or other apparatus to strut system

MATERIAL/FINISH

- Steel/Electroplated zinc

CERTIFICATIONS

- UL Listed

| PART # | HOLE THREAD | BOX QTY. |
|----------|-------------|----------|
| CNN-025 | 1/4" – 20 | 100 |
| CNN-038 | 3/8" – 16 | 100 |
| SNW01213 | 1/2" – 13 | 50 |

CONE NUT

FOR STRUT CHANNEL



SNCN1420

FEATURES

- Push and turn easy installation
- Teeth to bite into inside lip of strut

APPLICATION

- Secures fittings or other apparatus to strut system

MATERIAL/FINISH

- Steel/Electroplated zinc

| PART # | HOLE THREAD | BOX QTY. |
|----------|-------------|----------|
| SNCN1420 | 1/4" – 20 | 100 |
| SNCN3816 | 3/8" – 16 | 100 |
| SNCN1213 | 1/2" – 13 | 100 |

SQUEEZE NUT

FOR STRUT CHANNEL



SNSQ1420

FEATURES

- Push and turn easy installation
- Teeth to bite into inside lip of strut

APPLICATION

- Secures fittings or other apparatus to strut system

MATERIAL/FINISH

- Steel/Electroplated zinc

| PART # | HOLE THREAD | BOX QTY. |
|----------|-------------|----------|
| SNSQ1420 | 1/4" – 20 | 100 |
| SNSQ3816 | 3/8" – 16 | 100 |
| SNSQ1213 | 1/2" – 13 | 100 |

SQUARE CHANNEL WASHER

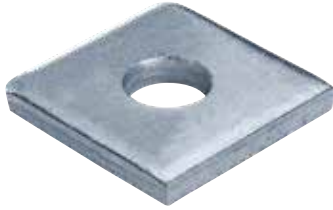

F130000EGTZ

| PART # | ROD SIZE | HOLE DIAMETER | BOX QTY. |
|-------------|----------|---------------|----------|
| F130000EGTZ | 5/16" | 3/8" | 100 |
| F140000EGTZ | 3/8" | 7/16" | 100 |
| F150000EGTZ | 1/2" | 9/16" | 100 |

APPLICATION

- Secures rods to strut channel

MATERIAL/FINISH

- Steel/Galvanized



STRUT WASHERS

"U/SADDLE" STYLE



SFU70-25

| PART # | BOLT SIZE | BOX QTY. |
|----------|-----------|----------|
| SFU70-25 | 1/4" - 20 | 50 |
| SFU70-38 | 3/8" - 16 | 50 |
| SFU70-50 | 1/2" - 13 | 50 |

FEATURES

- Saddle design prevents twisting or movement of washer

APPLICATION

- Use to secure all threaded rod to strut system

MATERIAL/FINISH

- Steel/Electroplated zinc

STRUT WASHERS

1-5/8" SQUARE STANDARD



SW-1/4-SS

FEATURES

- 1/4" thick steel

APPLICATION

- Use to secure all threaded rod to strut system

MATERIAL/FINISH

- Steel/Green powder coat finish, Electroplated zinc, or 316 Stainless steel

| PART # | BOLT SIZE | FINISH | BOX QTY. |
|-----------|-----------|---------------------|----------|
| SW-1/4-G | 1/4" | GREEN POWDER COAT | 100 |
| SW-3/8-G | 3/8" | | 100 |
| SW-1/2-G | 1/2" | | 100 |
| SW-5/8-G | 5/8" | | 100 |
| SW-1/4 | 1/4" | ZINC PLATED | 100 |
| SW-3/8 | 3/8" | | 100 |
| SW-1/2 | 1/2" | | 100 |
| SW-5/8 | 5/8" | | 100 |
| SW-1/4-SS | 1/4" | 316 STAINLESS STEEL | 100 |
| SW-3/8-SS | 3/8" | | 100 |
| SW-1/2-SS | 1/2" | | 100 |
| SW-5/8-SS | 5/8" | | 100 |

2" SQUARE, EXTRA LARGE



SW-2-3/8

FEATURES

- 1/4" thick steel

APPLICATION

- Use to secure all threaded rod to strut system

MATERIAL/FINISH

- Steel/Electroplated zinc

| PART # | BOLT SIZE | FINISH | BOX QTY. |
|----------|-----------|-------------|----------|
| SW-2-3/8 | 3/8" | ZINC PLATED | 100 |
| SW-2-1/2 | 1/2" | | 100 |
| SW-2-5/8 | 5/8" | | 100 |
| SW-2-3/4 | 3/4" | | 100 |

STRUT WASHERS

1-5/8" SQUARE, NOTCHED



SFF20

| PART # | BOLT SIZE | FINISH | BOX QTY. |
|--------|-----------|-------------|----------|
| SFF20 | 1/4" | ZINC PLATED | 100 |
| SFF21 | 3/8" | | 100 |
| SFF22 | 1/2" | | 100 |
| SFF23 | 5/8" | | 100 |
| SFF24 | 3/4" | | 100 |

FEATURES

- Notched design prevents twisting or movement of washer
- 1/4" thick steel

APPLICATION

- Use to secure all threaded rod to strut system

MATERIAL/FINISH

- Steel/Electroplated zinc

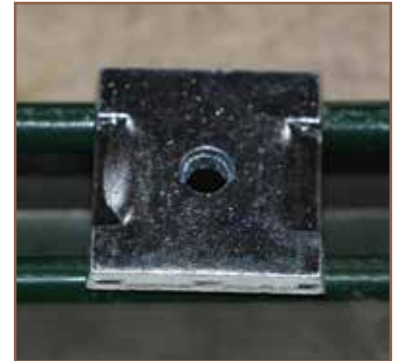

FLAT OCTAGON



12WFS

| PART # | BOLT SIZE | FINISH | BOX QTY. |
|--------|---------------|---------------------|----------|
| 12WFS | 1/4" OR 3/16" | ZINC PLATED STEEL | 100 |
| 13WFS | 1/2" | | 100 |
| 14WFS | 3/8" | | 100 |
| 12WFSS | 1/4" OR 3/16" | 304 STAINLESS STEEL | 100 |
| 13WFSS | 1/2" | | 100 |
| 14WFSS | 3/8" | | 100 |

FEATURES

- 1-1/2" O.D.
- Mounts inside strut channel

APPLICATION

- Use to secure all threaded rod to strut system

MATERIAL/FINISH

- Steel/Electroplated zinc or 304 Stainless steel

STUD/ DRYWALL

**Support and protection for electrical
circuits through termination within
the structure**

BOX SUPPORT SYSTEMS

CABLE/CONDUIT SUPPORT

NAIL PLATE

BOX SUPPORT SYSTEMS



FLOOR MOUNT BOX SUPPORT



FMBS18TZ

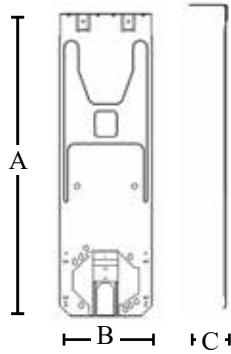

| PART # | A | B | C | BOX QTY. |
|----------|--------|-------|-------|----------|
| FMBS18TZ | 21.06" | 6.48" | 2.56" | 25 |

FEATURES

- Mounts inside or under wall stud tracks
- Built-in back support
- Meets ADA guidelines for 15" height minimum

APPLICATION

- Provides versatility in positioning electrical boxes in between wall studs

MATERIAL/FINISH

- Steel/Galvanized

CERTIFICATIONS

- UL Standard: UL 514A



SNAP-ON BOX SUPPORT



MSFTZ

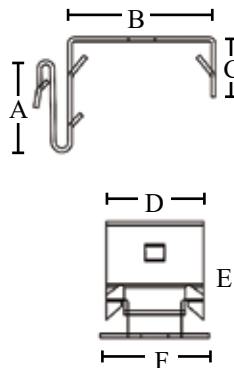

| PART # | A | B | C | D | E | F | BOX QTY. |
|--------|-------|-------|-------|----|-------|-------|----------|
| MSFTZ | .962" | 1.54" | .622" | 1" | 1.20" | 1.12" | 100 |

FEATURES

- Snaps on to metal/wood studs
- Clips onto box
- Center hole allows for screw attachment

APPLICATION

- Clip-on feature easily attaches electrical boxes to studs

MATERIAL/FINISH

- Spring Steel/GEOSEAL™

CERTIFICATIONS

- UL Standard: UL 2239



STEEL BOX SUPPORT



DS12ATZ

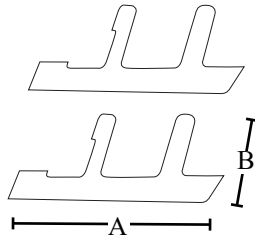

| PART # | A | B | BOX QTY. |
|---------|--------|-------|----------|
| DS12ATZ | 5.125" | 2.25" | 50 |

FEATURES

- Break apart design for easy handling
- Sold in pairs

APPLICATION

- Bendable, easy-to-use tabs secure metal boxes in drywall, lath, and plaster

MATERIAL/FINISH

- Steel



BOX MOUNTING BRACKET

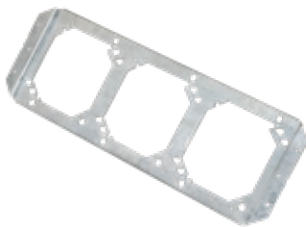

RBS16TZ

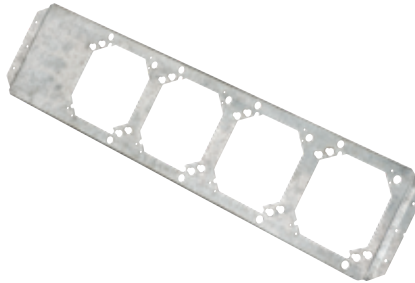

RBS24TZ

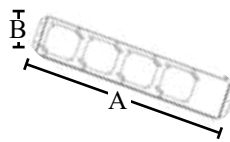
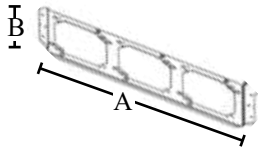

| PART # | STUD SPACING | A | B | BOX QTY. |
|---------|--------------|-----|----|----------|
| RBS16TZ | 16" | 16" | 5" | 20 |
| RBS24TZ | 24" | 24" | 5" | 20 |

FEATURES

- For use with 4" & 4-11/16" outlet boxes
- Suitable for 1-1/2" & 2-1/8" deep boxes
- Supports single or multiple boxes, plaster rings or low voltage devices

APPLICATION

- Secures multiple boxes between studs using one bracket; 16" supports up to 3 boxes and 24" supports up to 4 boxes

MATERIAL/FINISH

- Steel/Galvanized

CERTIFICATIONS

- UL Standard: UL514A



BOX MOUNTING BRACKET 3-POSITION FOR ADJUSTABLE DEPTH DEVICE RINGS



BMB3U

FEATURES

- Mounts up to three boxes and Southwire adjustable device covers

APPLICATION

- Bracket is used to position three junction boxes with Southwire adjustable device rings between wood or metal studs

MATERIAL/FINISH

- Steel/Galvanized

| PART # | ADJUST. DEPTH RING COMPATIBILITY | STUD CENTER DISTANCE | FITS SQUARE BOXES | BOX QTY. |
|--------|----------------------------------|----------------------|-------------------|----------|
| BMB3U | AMR1, AMR2, AMR0 | 16" | 4", 4-11/16" | 25 |

SCREW GUN BRACKETS



TSGB16TZ



FEATURES

- Notched and marked allows for easy identification and bending
- Pilot holes for easy box attachment
- Adjustable version for non-standard stud spacing
- Mounting holes length of bar for easy box installation
- 13 lbs. load capacity when intended to support a fixture or luminaire in a wall

APPLICATION

- Screw gun brackets allow electrical boxes to be quickly and easily installed between ceiling joists or wall studs

MATERIAL/FINISH

- Steel/Galvanized

CERTIFICATIONS

- UL Standard: UL 514A*



| PART # | SPAN | LENGTH | BOX DEPTHS | BOX QTY. |
|-------------|----------------|--------------------|------------------------|----------|
| SGB16ATZ* | NON-ADJUSTABLE | 16" | 1-1/2", 2-1/8" | 50 |
| TSGB16TZ* | ADJUSTABLE | 11-1/2" TO 17-3/4" | 1-1/2", 2-1/8" | 50 |
| TSGB1624TZ* | ADJUSTABLE | 14-1/4" TO 24-1/4" | 1-1/2", 2-1/8", 2-1/2" | 50 |
| BHAD16** | ADJUSTABLE | 11" TO 18"3" | 3-1/2" | 50 |
| BHAD24** | ADJUSTABLE | 17" TO 26" | 3-1/2" | 50 |

*cULus listed | **Not UL listed

HANGING AND SUPPORT

TELESCOPING BOX SUPPORT



TSRBS1625TZ

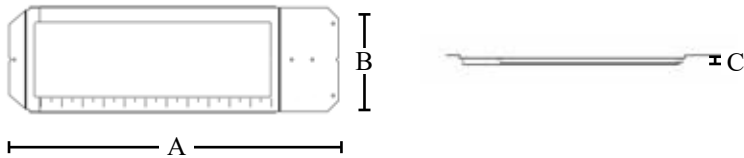

| PART # | A | B | C | BOX QTY. |
|-------------|--------|-------|-------|----------|
| TSRBS1625TZ | 17.56" | 4.94" | .561" | 25 |

FEATURES

- Telescoping feature accommodates studs from 16" to 24"
- Use with 4" square box and mud ring
- Will support 4 electrical boxes in 24" spacing
- Easily adjust box position after installed

APPLICATION

- Provides flexibility to support electrical boxes in-between wall studs

MATERIAL/FINISH

- Steel/Galvanized

CERTIFICATIONS

- UL Standard: UL 514A

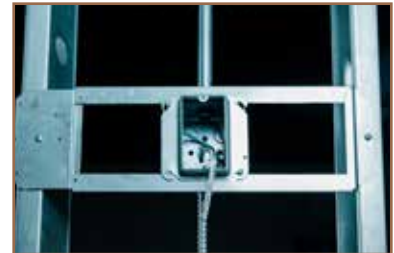

SLIDER BOX BRACKET

FOR BOX MOUNTING BETWEEN STUDS

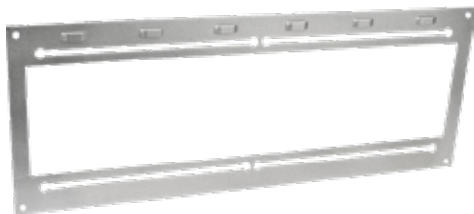

BMB16SL



| PART # | STUD CENTER DISTANCE | FITS SQUARE BOXES | BOX QTY. |
|----------|----------------------|-------------------|----------|
| BMB16SL | 16" | 4", 4-11/16" | 50 |
| BMB616SL | 16" | 6" | 50 |

FEATURES

- Full box adjustment left/right for exact placement of box/cover

APPLICATION

- Use to position a box with standard device ring between wood or metal studs

MATERIAL/FINISH

- Steel/Galvanized

CERTIFICATIONS

- UL Listed (exception BMB16SL)



SINGLE BOX MOUNTING BRACKET

FOR STANDARD DEVICE RINGS



BB4-26

| PART # | FAR-SIDE STAND OFF | FITS SQUARE BOXES | BOX QTY. |
|--------|--------------------|-------------------|----------|
| BB4-26 | 2-1/2", 3-5/8" | 4", 4-11/16" | 25 |
| BB6-26 | 2-1/2", 3-5/8" | 6" | 50 |

FEATURES

- Accepts 4", 4-11/16" and 6" square boxes and device rings
- Centering notch on face of bracket
- Either side of stud mount option

APPLICATION

- Universal box mounting brackets have a single stud face mount tab and can be used to support electrical boxes mounted on either side of a metal or wood stud
- Designed for use with standard device rings (mud rings) - see below

MATERIAL/FINISH

- Steel/Galvanized

CERTIFICATIONS

- UL Listed

STUD MOUNTING BRACKETS



C6TZ

BB4-25

BMB1U

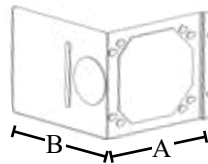
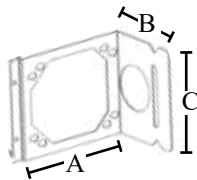

FEATURES

- Accepts 4" and 4-11/16" square boxes and adjustable device rings
- Centering notch on face of bracket

APPLICATION

- Universal box mounting brackets have a single stud face mount tab and can be used to support electrical boxes mounted to metal or wood studs
- Designed for use with Southwire adjustable device rings (mud rings)

MATERIAL/FINISH

- Steel/Galvanized

CERTIFICATIONS

- cULus Listed* or UL Listed**



| PART # | WALL DEPTH | A | B | C | BOX QTY. |
|---------|----------------------------|--------|-------|--------|----------|
| C6TZ* | 2-1/2" TO 6" | 3.50" | 4.50" | 5.625" | 50 |
| C23TZ* | 2-1/2" TO 3-5/8" | 5.875" | 4.50" | 5.625" | 50 |
| BB5-6 | 2-1/2", 3-5/8", 5-1/2", 6" | 3.50" | 4.50" | 5.625" | 50 |
| BB4-25 | 2-1/2" OR 3-5/8" | 6.50" | 6.50" | 11.40" | 50 |
| BMB1U** | 2-1/2" OR 3-5/8" | 3.46" | 5.38" | 5.38" | 50 |

*cULus listed | **Not UL listed



HANGING AND SUPPORT

CABLE/CONDUIT SUPPORT



CONDUIT TO STUD ATTACHMENT CLAMP



6MFTZ

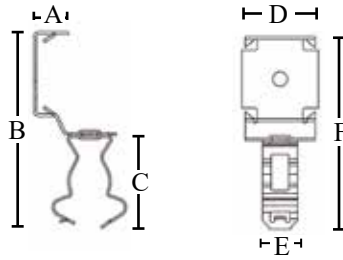

FEATURES

- Easily clips onto studs
- Stud clip size 1-3/8" to 1-1/2"
- Snap Close conduit support
- Screw hole feature allows clip to be screwed to stud for additional support

APPLICATION

- Conduit to stud attachment clamp easily secures conduit to studs without the need for tools

MATERIAL/FINISH

- Spring Steel/GEOSEAL™

CERTIFICATIONS

- UL Standard: UL 2239

| PART # | EMT SIZE | FLEX CONDUIT SIZE | MC/AC CABLE SIZE | BOX QTY. | A | B | C | D | E | F |
|---------|-------------|-------------------|------------------|----------|------|-------|-------|-------|------|-------|
| 6MFTZ | --- | 3/8" | 14-2 TO 12-3 | 100 | .63" | 1.53" | 1.68" | 1.38" | .63" | 3.55" |
| 16MFTZ | 1/2" & 3/4" | --- | --- | 100 | .63" | 1.53" | 2.52" | 1.38" | .63" | 4.39" |
| 20MFTZ | 1" | --- | --- | 50 | .63" | 1.53" | 2.96" | 1.38" | .63" | 4.83" |
| 812MFTZ | 1-1/4" | --- | --- | 100 | .63" | 1.53" | 2.05" | 1.38" | .63" | 3.92" |

CABLE TO METAL STUD CLIP



449TZ

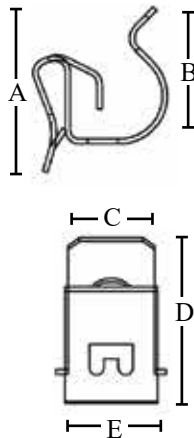

FEATURES

- Supports 14-3 to 12-3 MC/AC cables
- Easy no-tool installation

APPLICATION

- A quick and convenient solution to attach MC/AC cables to metal studs

MATERIAL/FINISH

- Spring Steel/GEOSEAL™

CERTIFICATIONS

- UL Standard: UL 2239



| PART # | A | B | C | D | E | BOX QTY. |
|--------|-------|-------|-------|-------|------|----------|
| 449TZ | .792" | .935" | .591" | 1.13" | .63" | 100 |

BOX SUPPORT BRACKET



766TZ



766ATZ

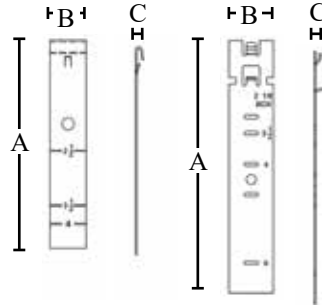

| PART # | WALL DEPTH | BOX CLIP FEATURE | A | B | C | BOX QTY. |
|--------|--------------------|------------------|-------|-------|-------|----------|
| 766TZ | 2-1/2, 3-5/8, 4 | SIDE WALL | 4.29" | .752" | .168" | 100 |
| 766ATZ | 2-1/2, 3-1/2, 4, 6 | SIDE HOLES | 5.14" | .092" | .150" | 100 |

FEATURES

- Easily clips to electrical boxes

APPLICATION

- Provides electrical box support for multiple wall depths

MATERIAL/FINISH

- Steel/Galvanized

CERTIFICATIONS

- UL Standard: UL 514A



CONDUIT TO STUD CLAMP



350812MTZ

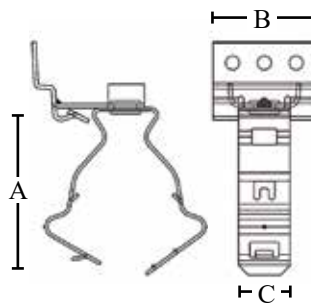

| PART # | A | B | C | BOX QTY. |
|-----------|-------|-------|-------|----------|
| 350812MTZ | 2.05" | 1.26" | .630" | 100 |

FEATURES

- Supports 1/2" and 3/4" EMT
- Clip rotates 360° for easy positioning
- Secures to stud with screws
- Snap-close clip

APPLICATION

- Allows positioning of conduit to any size wood or metal studs

MATERIAL/FINISH

- Spring Steel/GEOSEAL™

CERTIFICATIONS

- UL Standard: UL 2239



CABLE/CONDUIT STUD CLIP



AR812TZ

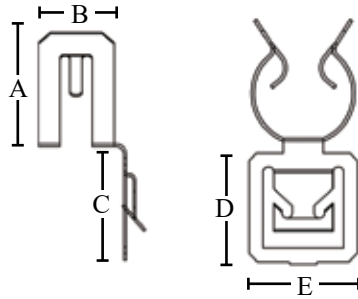

FEATURES

- Supports 1/2", 3/4" EMT, 1/2" Rigid
- Reduces conduit rattling
- Snaps on to metal studs, no tools required

APPLICATION

- Provides support for EMT, Rigid, or MC/AC cables through metal studs

MATERIAL/FINISH

- Spring Steel/GEOSEAL™

CERTIFICATIONS

- UL Standard: UL 2239



| PART # | A | B | C | D | E | BOX QTY. |
|---------|-------|-------|-------|----|----|----------|
| AR812TZ | 1.13" | .748" | 1.14" | 1" | 1" | 100 |

MC, NM TO STUD WALL



CJ6TZ



CJIN



FEATURES

- Supports up to 6 runs of NM sheathed cable or 4 runs of MC and AC cables
- Collapsible leg locks and secures cables for a snug fit
- Locating ribs to maintain cable separation

APPLICATION

- Easily installs to secure NM or MC cables to wood or metal studs
- Designed with a flared edge for maximum cable protection

MATERIAL/FINISH

- Steel/Zinc plated

CERTIFICATIONS

- UL Standard: UL 2239
- NEC® 300.4D applicable



| PART # | CABLE SURFACE | LENGTH | BOX QTY. |
|--------|------------------|--------|----------|
| CJ6TZ | STEEL | 6" | 100 |
| CJIN | INSULATED RUBBER | 6" | 100 |

| STUD TYPE | CABLE TYPE | CABLE SIZE | CABLES PER FASTENER |
|------------|-----------------|--|---------------------|
| WOOD | NON-METALLIC | 14-2, 12-2, 10-2, 14-3, 12-3, AND 10-3 WITH GROUND | MAX 6 |
| | | 8-2 AND 6-2 WITH GROUND | MAX 4 |
| METAL STUD | METAL CLAD (MC) | 14-2, 12-2, 10-2, 14-3, 12-3, 10-3, 14-4, 12-4, AND 10-4 WITH GROUND | MAX 4 |

HANGING AND SUPPORT

NAIL STRAP CONDUIT SUPPORT

WOOD STUD MOUNT



DS1TZ

FEATURES

- Stamped teeth and pointed tip prevent accidental pull out

APPLICATION

- Secures EMT or Rigid/IMC conduit to wood stud or surface

MATERIAL/FINISH

- Stamped steel/Zinc plated

| PART # | FOR EMT CONDUIT | FOR RIGID CONDUIT | INNER QTY. | BOX QTY. |
|--------|-----------------|-------------------|------------|----------|
| DS1TZ | 1/2" | 3/8" | 100 | 1000 |
| DS2 | 3/4" | 1/2" | 100 | 1000 |
| DS3 | 1" | 3/4" | 100 | 1000 |

CAST NAIL STRAP CONDUIT SUPPORT

WOOD STUD MOUNT



1600-CS

FEATURES

- 30% higher tensile strength vs. malleable iron
- Withstands greater striking force

APPLICATION

- Secures EMT or Rigid/IMC conduit to wood stud or surface

MATERIAL/FINISH

- Cast steel/Zinc plated

| PART # | FOR EMT CONDUIT | FOR RIGID CONDUIT | INNER QTY. | BOX QTY. |
|---------|-----------------|-------------------|------------|----------|
| 1600-CS | 1/2" | 3/8" | 100 | 1000 |
| 1605-CS | 3/4" | 1/2" | 100 | 1000 |
| 1615-CS | 1" | 3/4" | 100 | 1000 |

CABLE/CONDUIT TO STUD BRACKET



CS812TZ

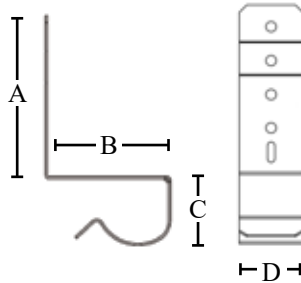

FEATURES

- Supports 14-3 to 10-2 MC/AC cables
- Can be used on wood or metal studs

APPLICATION

- Provides a solution to attach EMT conduit or MC/AC cables to studs
- The multiple mounting holes allow for easy alignment of cable to junction box knockouts

MATERIAL/FINISH

- Spring Steel/GEOSEAL™

CERTIFICATIONS

- UL Standard: UL 2239



| PART # | A | B | C | D | BOX QTY. |
|----------|-------|-------|-------|----|----------|
| CS16TZ | 2.67" | 2.07" | 1.14" | 1" | 100 |
| CS812TZ | 2.67" | 1.42" | .811" | 1" | 100 |
| CS812DTZ | 2.67" | 2.04" | .811" | 1" | 100 |

CLIP-ON CABLE TO STUD CLIP



FXC20TZ

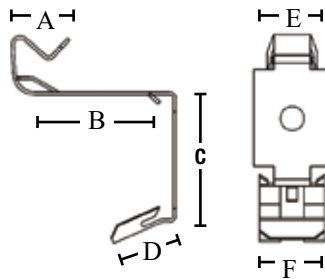

FEATURES

- Supports 14-2 to 12-3 MC/AC cables
- Includes screw mounting hole to provide additional support

APPLICATION

- Clips on to studs to provide a cable management solution for MC/AC cables.
- Results in a clean and professional installation

MATERIAL/FINISH

- Spring Steel/GEOSEAL™

CERTIFICATIONS

- UL Standard: UL 2239



| PART # | A | B | C | D | E | F | BOX QTY. |
|---------|-------|-------|-------|-------|-------|-------|----------|
| FXC20TZ | .672" | 1.89" | 1.50" | .745" | .882" | .752" | 100 |

SNAP-IN CABLE BRACKET



MAC2TZ

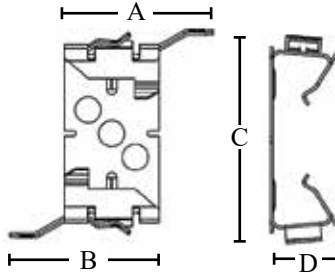

FEATURES

- Supports 14-2 to 10-3 MC/AC cables
- 1/8" max flange thickness
- Can be separated to create two separate clips
- Mounting holes allow for anchoring to wood, concrete or block

APPLICATION

- Clips onto flanges without tools or screws to wood, block, concrete, or metal studs
- Secures MC/AC cables to studs

MATERIAL/FINISH

- Spring Steel/GEOSEAL™

CERTIFICATIONS

- UL Standard: UL 2239



| PART # | A & B | C | D | BOX QTY. |
|--------|-------|--------|-------|----------|
| MAC2TZ | 1.57" | 1.967" | .647" | 100 |

SCREW-ON CABLE TO STUD CLIP



MCS100TZ

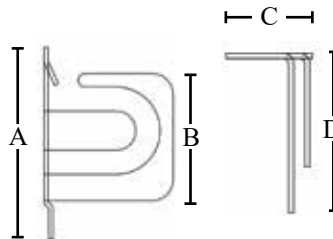

FEATURES

- Supports 14-3 to 10-2 MC/AC cables
- Can be used on metal or wood studs

APPLICATION

- Screws on to studs to provide a cable management solution for MC/AC cables
- Results in a clean and professional installation

MATERIAL/FINISH

- Steel/Galvanized

CERTIFICATIONS

- UL Standard: UL 2239



| PART # | A | B | C | D | BOX QTY. |
|----------|-------|-------|-------|-------|----------|
| MCS100TZ | 3.66" | 2.42" | 1.29" | 2.46" | 100 |

CABLE STAPLES



183

| PART # | CABLE RANGE | SIZE | INNER QTY | MASTER QTY |
|--------|--|--------|-----------|------------|
| 183 | ARMORED CABLE 14/2 & 14/3 | 1/2" | 100 | 5000 |
| 184 | METAL CLAD CABLE 14/2 & 14/3 | 1/2" | 500 | 5000 |
| 185 | NONMETALLIC SHEATHED 14/2 THROUGH 10/3 UNDERGROUND FEEDER 14/2 & 14/3 | 1/2" | BUCKET | 5000 |
| 193 | ARMORED CABLE 14/2 THROUGH 10/3 | 9/16" | 100 | 5000 |
| 194 | METAL CLAD CABLE 14/2 THROUGH 10/3 | 9/16" | 500 | 5000 |
| 195 | NONMETALLIC SHEATHED 12/3 THROUGH 10/3 UNDERGROUND FEEDER 14/2 & 12/3 | 9/16" | BUCKET | 5000 |
| 196 | ARMORED CABLE 8/3 | 13/16" | 100 | 5000 |
| 197 | METAL CLAD CABLE 8/3 NONMETALLIC SHEATHED 18/3 THROUGH 6/3 UNDERGROUND FEEDER 10/3 | 13/16" | 500 | 5000 |

FEATURES

- Pointed legs drive straight and limit splitting of wood
- Recessed heads drive fast and protect cable insulation
- Sharp tips for easier starting
- Strong, resilient steel construction

APPLICATION

- Secures Romex® Brand nonmetallic sheathed cable, armored cable, metal clad cable, and feeder cable

MATERIAL

- Steel

SERVICE ENTRANCE

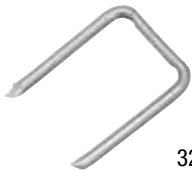

32-1

| PART # | CABLE RANGE | SIZE | INNER QTY | MASTER QTY |
|--------|---------------------------|-----------------|-----------|------------|
| 32-1 | #6/3 SEU | 3/4" x 1-5/16" | 100 | 1000 |
| 34-1 | #2/3 SEU | 1" x 1" | 100 | 1000 |
| 36-1 | #4/0 SEU | 1-5/8" x 2-1/8" | 100 | 500 |
| 186 | #4/3 SEU THROUGH #2/3 SER | 1-11/16" | 100 | 1000 |
| 198 | 2/0 SEU THROUGH 2/0 SER | 1-11/32" | 100 | 1000 |

FEATURES

- Pointed offset to drive in straight
- Strong, resilient steel construction

APPLICATION

- Secures Romex® Brand nonmetallic sheathed cable, armored cable, BX, and flexible conduit to wood or masonry

MATERIAL

- Steel

INSULATED



183I

| PART # | CABLE RANGE | SIZE | INNER QTY | MASTER QTY |
|--------|--|------|-----------|------------|
| 183I | ARMORED CABLE 14/2 & 14/3 | 1/2" | 100 | 5000 |
| 184I | METAL CLAD CABLE 14/2 & 14/3 | 1/2" | 500 | 5000 |
| 185I | NONMETALLIC SHEATHED 14/2 THROUGH 10/3 UNDERGROUND FEEDER 14/2 & 14/3 | 1/2" | BUCKET | 2500 |

FEATURES

- Plastic insulator protects cable
- Strong, resilient steel construction

APPLICATION

- Secures Romex® Brand nonmetallic sheathed cable, armored cable, metal clad cable, and feeder cable

MATERIAL

- Steel nail with plastic insulator

NAIL PLATES

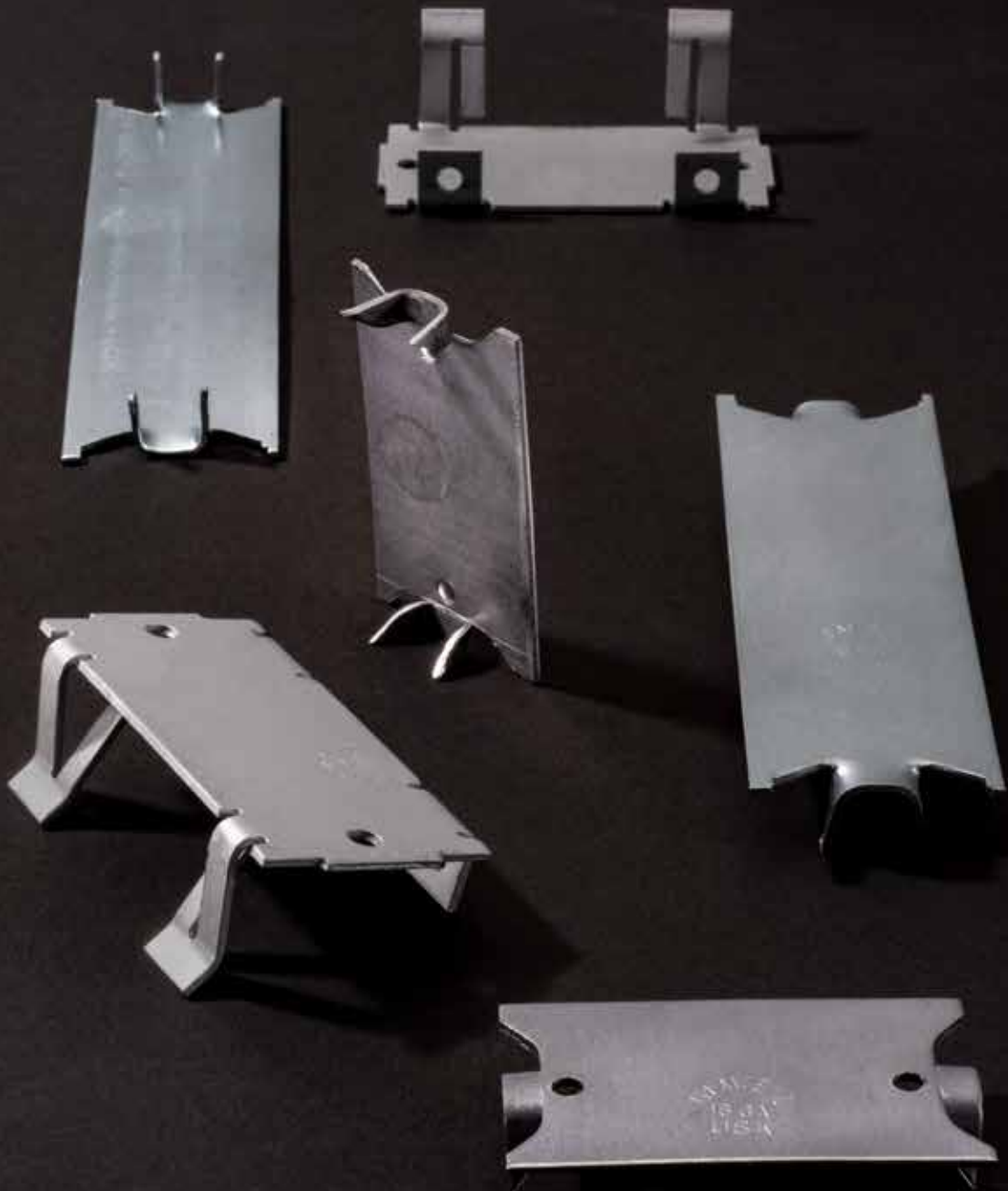

PRESS-ON NAIL PLATE



304B2TZ

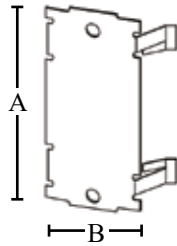

| PART # | A | B | C | D | BOX QTY. |
|---------|-------|-------|-------|-------|----------|
| 304B2TZ | 3.13" | 1.50" | .547" | 1.02" | 100 |

FEATURES

- Easy no-tool installation
- For metal or wood studs
- Holes provided on clip legs to screw into stud for additional support

APPLICATION

- Press-on nail plates protect electrical and mechanical gear routed through studs

MATERIAL/FINISH

- Steel/GEOSEAL™

CERTIFICATIONS

- UL Standard: UL 2239



NAIL PLATES



SP-3



SP-6



188



43-50

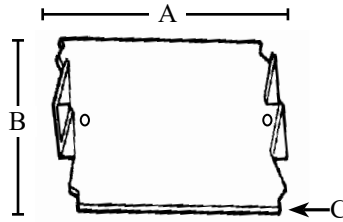

FEATURES

- 16-gauge thickness
- Hammer-on installation
- Spiked ends for wood studs
- Clip tabs for metal studs

APPLICATION

- Use to protect wire and cable from nails or screws in wood stud construction
- Mounts on outside of the stud face

MATERIAL/FINISH

- Steel



| PART # | STUD MATERIAL | ATTACHMENT | PLATE SIZE | A | B | C | BOX QTY. |
|--------|---------------|------------|--------------------------------|-------|-------|--------|----------|
| SP-3 | WOOD | SPIKE | 1-1/2" x 2-1/2" | 2.50" | 1.50" | .0625" | 200 |
| SP-6 | WOOD | SPIKE | 1-1/2" x 6" x 1/16" | 5" | 1.50" | .0625" | 100 |
| 187A | WOOD | SPIKE | 3-1/2" x 6" x 1/16" | 6" | 3.50" | .0625" | 50 |
| 188 | WOOD | SPIKE | 1-1/2" x 5" x 1/16" | 6" | 1.50" | .0625" | 100 |
| 189B | WOOD | SPIKE | 1-1/2" x 2-1/2" x 1/16" | 2.50" | 1.50" | .0625" | 50 |
| 43-50 | WOOD | SPIKE | 1-1/2" x 2-1/2" | 2.50" | 1.50" | .0625" | 250 |
| 43-100 | WOOD | SPIKE | 1-1/2" x 2-1/2" | 2.50" | 1.50" | .0625" | 100 |
| 43-5P | WOOD | SPIKE | 1-1/2" x 2-1/2" (PAIL PACK) | 2.50" | 1.50" | .0625" | 500 |

DATACOM/ LOW VOLTAGE

**Wire management systems that
support data and low voltage cables
to the structure**

**CABLE SUPPORT SYSTEMS
LOW VOLTAGE CABLE MANAGEMENT
CLIPS**

CABLE SUPPORT SYSTEMS



J-HOOKS

WALL MOUNT WITH MOUNTING HOLES



CAT12TZ

CAT21TZ

JHK-32SS

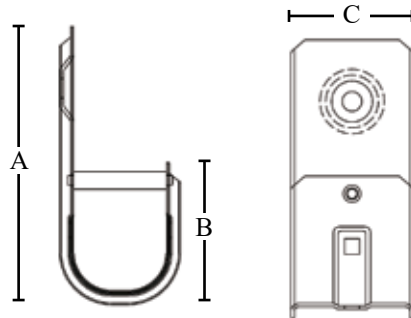

FEATURES

- J-Hooks eliminate the problem of point loads that can cause band width damage to sensitive cables such as fiber optic, CAT 5E, 6, 7 or many others
- Continuous wide base radius design supports the natural bends and curves of cable
- Built-in cable retainer bar
- .264" diameter mounting hole

APPLICATION

- Wall mount J-Hook cable supports can be attached to a wide variety of wall surfaces
- Southwire J-Hooks are an inexpensive alternative to cable trays
- J-Hooks provide support to sensitive voice and data cables without causing stress

MATERIAL/FINISH

- Steel/Galvanized or Stainless steel

CERTIFICATIONS

- * cULus Listed
- **UL listed



| PART # | HOOK DIAMETER | MATERIAL | STATIC LOAD (LBS.) | CAT 5E CABLE CAPACITY | A | B | C | BOX QTY. |
|------------|---------------|------------------|--------------------|-----------------------|-------|-------|-------|----------|
| CAT12TZ* | 3/4" | GALVANIZED STEEL | 60 | 16 | 3.23" | 1.65" | .866" | 100 |
| CAT21TZ* | 1-5/16" | | 60 | 50 | 3.62" | 1.79" | 1.64" | 40 |
| CAT32TZ* | 2" | | 60 | 90 | 4.37" | 2.50" | 1.64" | 50 |
| CAT64TZ* | 4" | | 60 | 330 | 4.48" | 2.50" | 1.91" | 25 |
| JHK-84 | 6" | | 60 | 450 | 6.93" | 3.75" | 2.02" | 25 |
| JHK-12SS** | 3/4" | STAINLESS STEEL | 60 | 20 | 3.23" | 1.65" | .866" | 50 |
| JHK-21SS** | 1-5/16" | | 60 | 40 | 3.62" | 1.79" | 1.64" | 50 |
| JHK-32SS** | 2" | | 60 | 80 | 4.37" | 2.50" | 1.64" | 50 |
| JHK-64SS** | 4" | | 60 | 300 | 4.48" | 2.50" | 1.91" | 25 |

Load Limits apply to fastener only. Anchor must be evaluated separately

*cULus Listed, **UL listed, JHK-84- no UL

HANGING AND SUPPORT

J-HOOKS WITH SPRING

STEEL BEAM CLAMP



CAT21BCTZ

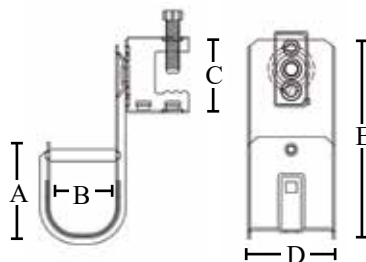

FEATURES

- Available in multiple sizes
- Alternative cable management solution to complex cable trays
- J-Hooks are designed with round edges to provide proper bend radius
- Beam clamp screw-on attachment allows for easy repositioning of the J-Hook

APPLICATION

- J-Hooks with screw-on beam clamp feature allows the J-Hook to easily attach to beam flanges
- J-Hooks provide support for data cables: fiber optic, inner-duct and low voltage

MATERIAL/FINISH

- Clamp: Spring Steel/ GEOSEAL™
- J-Hook: Steel/Galvanized

CERTIFICATIONS

- UL Standard: UL 2239



| PART # | HOOK DIAMETER | A | B | C | D | E | BOX QTY. |
|-----------|---------------|-------|-------|-------|-------|-------|----------|
| CAT12BCTZ | 3/4" | 1.65" | .748" | 1.42" | .866" | 3.23" | 40 |
| CAT21BCTZ | 1-5/16" | 1.79" | 1.24" | 1.42" | 1.64" | 3.62" | 50 |
| CAT32BCTZ | 2" | 2.50" | 1.99" | 1.42" | 1.64" | 4.37" | 50 |



J-HOOKS WITH BEAM CLAMP



JHK-21-BC

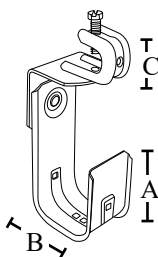

FEATURES

- J-Hooks eliminate the problem of point loads that can cause band width damage to sensitive cables such as fiber optic, CAT 5E, 6, 7 or many others
- Continuous wide base radius design supports the natural bends and curves of cable
- Built-in cable retainer bar

APPLICATION

- J-Hook cable support with stamped steel beam clamp can be attached to a wide variety of flange edges or beams
- Southwire J-Hooks are an inexpensive alternative to cable trays
- J-Hooks provide support to sensitive voice and data cables without causing stress

MATERIAL/FINISH

- Steel/Zinc plated

| PART # | HOOK DIAMETER | A | B | C | BOX QTY. |
|-----------|---------------|-------|-------|-------|----------|
| JHK-21-BC | 1-5/16" | 3.62" | 1.63" | 1.64" | 50 |
| JHK-32-BC | 2" | 4.37" | 1.63" | 1.64" | 50 |
| JHK-64-BC | 4" | 4.48" | 1.63" | 1.91" | 25 |

J-HOOKS, BEAM/EDGE MOUNT

HAMMER-ON CLIP



JHK-12-H0



CAT3224TZ

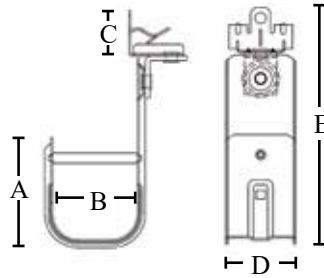

FEATURES

- J-Hooks eliminate the problem of point loads that can cause band width damage to sensitive cables such as fiber optic, CAT 5E, 6, 7 or many others
- Continuous wide base radius design supports the natural bends and curves of cable
- Built-in cable retainer bar
- 360° rotation of J-Hook

APPLICATION

- J-Hook cable supports with hammer-on beam edge clip can be attached to a wide variety of flange edges or beams
- Southwire J-Hooks are an inexpensive alternative to cable trays
- J-Hooks provide support to sensitive voice and data cables without causing stress

MATERIAL/FINISH

- Clamp: Spring Steel/ GEOSEAL™
- J-Hook: Steel/Galvanized

CERTIFICATIONS

- UL Standard: UL 2239



| PART # | BEAM FLANGE THICKNESS | HOOK DIAMETER | CAT5E CABLE CAPACITY | A | B | C | D | E | BOX QTY. |
|----------------|-----------------------|---------------|----------------------|-------|-------|-------|-------|-------|----------|
| JHK-12-H0** | 1/8" TO 1/4" | 3/4" | 20 | .748" | 1.65" | 1.06" | .866" | 4.29" | 50 |
| JHK-12-H0516** | 5/16" TO 1/2" | 3/4" | 20 | .748" | 1.65" | 1.34" | .866" | 4.57" | 50 |
| JHK-12-H0916** | 9/16" TO 3/4" | 3/4" | 20 | .748" | 1.65" | 1.63" | .866" | 4.86" | 50 |
| JHK-21-H0** | 1/8" TO 1/4" | 1-5/16" | 40 | 1.24" | 1.79" | 1.06" | 1.64" | 4.68" | 50 |
| JHK-21-H0516** | 5/16" TO 1/2" | 1-5/16" | 40 | 1.24" | 1.79" | 1.34" | 1.64" | 4.96" | 50 |
| JHK-21-H0916** | 9/16" TO 3/4" | 1-5/16" | 40 | 1.24" | 1.79" | 1.63" | 1.64" | 5.25" | 50 |
| CAT3224TZ* | 1/8" TO 1/4" | 2" | 80 | 1.99" | 2.5" | 1.06" | 1.64" | 5.43" | 50 |
| JHK-32-H0516** | 5/16" TO 1/2" | 2" | 80 | 1.99" | 2.5" | 1.34" | 1.64" | 5.71" | 50 |
| JHK-32-H0916** | 9/16" TO 3/4" | 2" | 80 | 1.99" | 2.5" | 1.63" | 1.64" | 6" | 50 |
| JHK-64-H0** | 1/8" TO 1/4" | 4" | 300 | 4.0" | 4.69" | 1.06" | 1.91" | 7.99" | 25 |
| JHK-64-H0516** | 5/16" TO 1/2" | 4" | 300 | 4.0" | 4.69" | 1.34" | 1.91" | 8.27" | 25 |
| JHK-64-H0916** | 9/16" TO 3/4" | 4" | 300 | 4.0" | 4.69" | 1.63" | 1.91" | 8.56" | 25 |

*cULus Listed, **UL listed

J-HOOKS WITH CLIP



JHK-12-BW2

CAT124Z34TZ

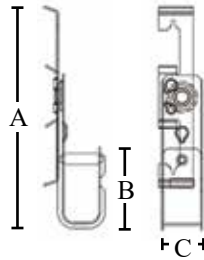

FEATURES

- Easy no-tool installation
- Available in multiple sizes
- J-Hooks are designed with round edges to provide proper bend radius
- Rod/wire clip feature allows for easy repositioning of J-Hook

APPLICATION

- J-Hook with clip feature allows the J-Hook to easily attach to beams, threaded rods, or wires
- J-Hooks provide support for data cables: fiber optic, inner-duct, and low voltage

MATERIAL/FINISH

- Clip: Spring Steel/ GEOSEAL™
- J-Hook: Steel/Galvanized

CERTIFICATIONS

- UL Standard: UL 2239

| PART # | HOOK DIAMETER | ROD SIZE | A | B | C | BOX QTY. |
|--------------|---------------|----------|--------|-------|-------|----------|
| CAT124Z34TZ* | 3/4" | 1/4" | 3.23" | 1.65" | .866" | 40 |
| CAT126Z34TZ* | 3/4" | 3/8" | 4.171" | 1.65" | .866" | 50 |
| JHK-21-BW2** | 1-5/16" | 1/4" | 4.561" | 1.79" | 1.64" | 50 |
| JHK-21-BW6** | 1-5/16" | 3/8" | 4.561" | 1.79" | 1.64" | 50 |
| CAT324Z34TZ* | 2" | 1/4" | 5.311" | 2.50" | 1.64" | 50 |
| CAT326Z34TZ* | 2" | 3/8" | 5.311" | 2.50" | 1.64" | 50 |
| JHK-64-BW2** | 4" | 1/4" | 5.421" | 2.50" | 1.91" | 25 |

*cULus Listed | **UL listed



J-HOOKS, MAGNETIC MOUNT



JHK-12MAG



FEATURES

- J-Hooks eliminate the problem of point loads that can cause band width damage to sensitive cables such as fiber optic, CAT 5E, 6, 7 or many others
- Continuous wide base radius design supports the natural bends and curves of cable
- Built-in cable retainer bar

APPLICATION

- Magnetic wall mount J-Hook cable supports can be attached to a wide variety of metal wall surfaces
- Southwire J-Hooks are an inexpensive alternative to cable trays
- J-Hooks provide support to sensitive voice and data cables without causing stress

MATERIAL/FINISH

- Steel/Zinc plated

CERTIFICATIONS

- UL Listed

| PART # | MATERIAL | HOOK SIZE | CAT5E CABLE CAPACITY | PULL-OUT STRENGTH | BOX QTY. |
|-----------|-------------------|-----------|----------------------|-------------------|----------|
| JHK-12MAG | ZINC PLATED STEEL | 3/4" | 20 | 90 LBS. | 50 |
| JHK-21MAG | | 1-5/16" | 40 | 90 LBS. | 50 |
| JHK-32MAG | | 2" | 80 | 90 LBS. | 50 |
| JHK-64MAG | | 4" | 300 | 90 LBS. | 25 |
| JHK-84MAG | | 6" | 450 | 90 LBS. | 25 |

J-HOOKS OVERHEAD MOUNT



JHK-12-AB

JHK-21-ABSS



| PART # | MATERIAL | HOOK SIZE | CAT5E CABLE CAPACITY | BOX QTY. |
|-------------|---------------------|-----------|----------------------|----------|
| JHK-12-AB | ZINC PLATED STEEL | 3/4" | 20 | 50 |
| JHK-21-AB | | 1-5/16" | 40 | 50 |
| JHK-32-AB | | 2" | 80 | 50 |
| JHK-64-AB | | 4" | 300 | 25 |
| JHK-12-ABSS | 316 STAINLESS STEEL | 3/4" | 20 | 50 |
| JHK-21-ABSS | | 1-5/16" | 40 | 50 |
| JHK-32-ABSS | | 2" | 80 | 50 |
| JHK-64-ABSS | | 4" | 300 | 25 |

FEATURES

- J-Hooks eliminate the problem of point loads that can cause band width damage to sensitive cables such as fiber optic, CAT 5E, 6, 7 or many others
- Continuous wide base radius design supports the natural bends and curves of cable
- Built-in cable retainer bar
- .26" diameter mounting hole

APPLICATION

- Overhead mount J-Hook cable supports can be attached to a wide variety of overhead surfaces or combined with other Southwire spring steel hardware
- Southwire J-Hooks are an inexpensive alternative to cable trays
- J-Hooks provide support to sensitive voice and data cables without causing stress

MATERIAL/FINISH

- Steel/Zinc plated or 316 Stainless steel

CERTIFICATIONS

- UL Listed (for Zinc plated Steel)

MAGNETIC OVERHEAD MOUNT J-HOOKS



JHK-12ABMAG



FEATURES

- J-Hooks eliminate the problem of point loads that can cause band width damage to sensitive cables such as fiber optic, CAT 5E, 6, 7 or many others
- Continuous wide base radius design supports the natural bends and curves of cable
- Built-in cable retainer bar

APPLICATION

- Magnetic overhead mount J-Hook cable supports can be attached to a wide variety of metal overhead surfaces
- Southwire J-Hooks are an inexpensive alternative to cable trays
- J-Hooks provide support to sensitive voice and data cables without causing stress

MATERIAL/FINISH

- Steel/Zinc plated

| PART # | MATERIAL | HOOK SIZE | CAT5E CABLE CAPACITY | PULL-OUT STRENGTH | BOX QTY. |
|-------------|-------------------|-----------|----------------------|-------------------|----------|
| JHK-12ABMAG | ZINC PLATED STEEL | 3/4" | 20 | 90 LBS. | 50 |
| JHK-21ABMAG | | 1-5/16" | 40 | 90 LBS. | 50 |
| JHK-32ABMAG | | 2" | 80 | 90 LBS. | 50 |
| JHK-64ABMAG | | 4" | 300 | 90 LBS. | 25 |

HANGING AND SUPPORT

FLOOR SUPPORT J-HOOK



CAT21CD1BTZ

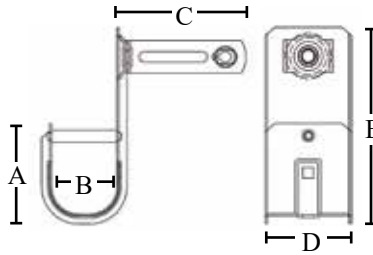

| PART # | A | B | C | D | E | BOX QTY. |
|-------------|-------|-------|-------|-------|-------|----------|
| CAT21CD1BTZ | 1.79" | 1.24" | 2.26" | 1.64" | 3.62" | 50 |

FEATURES

- J-Hooks are designed with round edges to provide proper bend radius
- 1-5/16" diameter J-Hook

APPLICATION

- J-Hooks provide support for data cables: fiber optic, inner duct and low voltage
- Pipe anchor clamp feature allows the J-Hook to easily attach to floor supports

MATERIAL/FINISH

- Steel/Galvanized

CERTIFICATIONS

- UL Standard: UL 2239



MULTI-RUN OVERHEAD MOUNT J-HOOKS



JHT-212



JHT-214



JHT-216

FEATURES

- J-Hooks eliminate the problem of point loads that can cause band width damage to sensitive cables such as fiber optic, CAT5E, 6, 7 or many others
- Continuous wide base radius design supports the natural bends and curves of cable
- Built-in cable retainer bar
- .26" diameter mounting hole

APPLICATION

- Overhead mount multi-run J-Hook cable supports can be attached to a wide variety of overhead surfaces.
- Southwire J-Hooks are an inexpensive alternative to cable trays
- J-Hooks provide support to sensitive voice and data cables without causing stress

MATERIAL/FINISH

- Steel/Zinc plated

| PART # | NUMBER OF HOOKS | HOOK DIAMETER | CAT5E CABLE CAPACITY | BOX QTY. |
|---------|-----------------|---------------|----------------------|----------|
| JHT-212 | 2 | 1-5/16" | 40 EACH HOOK | 25 |
| JHT-214 | 4 | 1-5/16" | 40 EACH HOOK | 25 |
| JHT-216 | 6 | 1-5/16" | 40 EACH HOOK | 25 |
| JHT-322 | 2 | 2" | 80 EACH HOOK | 25 |
| JHT-324 | 4 | 2" | 80 EACH HOOK | 25 |
| JHT-326 | 6 | 2" | 80 EACH HOOK | 25 |
| JHT-642 | 2 | 4" | 300 EACH HOOK | 10 |
| JHT-644 | 4 | 4" | 300 EACH HOOK | 10 |
| JHT-646 | 6 | 4" | 300 EACH HOOK | 10 |

G-HOOKS, WALL MOUNT



CAT150-WM



FEATURES

- Provides a smooth surface for cables
- .28" diameter mounting hole

APPLICATION

- Wall mount G-Hook cable supports can be attached to a wide variety of wall surfaces and are a cost effective alternative to J-Hooks
- G-Hooks provide support to sensitive voice and data cables without causing stress

MATERIAL/FINISH

- Steel/Zinc plated

CERTIFICATIONS

- cULus Listed

| PART # | MATERIAL | LOOP SIZE | CAT5E CABLE CAPACITY | BOX QTY. |
|-----------|-------------------|-----------|----------------------|----------|
| CAT150-WM | ZINC PLATED STEEL | 1-1/2" | 36 | 50 |
| CAT200-WM | | 2" | 71 | 50 |
| CAT400-WM | | 4" | 250 | 25 |

MAGNETIC MOUNT



CAT150-WMAG

FEATURES

- Provides a smooth surface for cables

APPLICATION

- Magnetic mount G-Hook cable supports can be attached to a wide variety of metal wall surfaces and are a cost effective alternative to J-Hooks
- G-Hooks provide support to sensitive voice and data cables without causing stress

MATERIAL/FINISH

- Steel/Zinc plated

| PART # | MATERIAL | LOOP SIZE | CAT5E CABLE CAPACITY | PULL-OUT STRENGTH | BOX QTY. |
|-------------|-------------------|-----------|----------------------|-------------------|----------|
| CAT150-WMAG | ZINC PLATED STEEL | 1-1/2" | 36 | 90 LBS. | 50 |
| CAT200-WMAG | | 2" | 71 | 90 LBS. | 50 |
| CAT400-WMAG | | 4" | 250 | 90 LBS. | 25 |

G-HOOKS, OVERHEAD MOUNT



CAT150-AB



| PART # | MATERIAL | LOOP SIZE | CAT5E CABLE CAPACITY | BOX QTY. |
|-----------|-------------------|-----------|----------------------|----------|
| CAT150-AB | ZINC PLATED STEEL | 1-1/2" | 36 | 50 |
| CAT200-AB | | 2" | 71 | 50 |
| CAT400-AB | | 4" | 250 | 25 |

FEATURES

- Provides a smooth surface for cables
- .28" diameter mounting hole

APPLICATION

- Overhead mount G-Hook cable supports can be attached to a wide variety of overhead surfaces and are a cost effective alternative to J-Hooks
- G-Hooks provide support to sensitive voice and data cables without causing stress

MATERIAL/FINISH

- Steel/Zinc plated

MAGNETIC MOUNT



CAT150-MAG

| PART # | MATERIAL | LOOP SIZE | CAT5E CABLE CAPACITY | PULL-OUT STRENGTH | BOX QTY. |
|------------|-------------------|-----------|----------------------|-------------------|----------|
| CAT150-MAG | ZINC PLATED STEEL | 1-1/2" | 36 | 90 LBS. | 50 |
| CAT200-MAG | | 2" | 71 | 90 LBS. | 50 |
| CAT400-MAG | | 4" | 250 | 90 LBS. | 25 |

FEATURES

- Provides a smooth surface for cables

APPLICATION

- Overhead magnetic mount G-Hook cable supports can be attached to a wide variety of metal overhead surfaces and are a cost effective alternative to J-Hooks
- G-Hooks provide support to sensitive voice and data cables without causing stress

MATERIAL/FINISH

- Steel/Zinc plated

1/4"-20 THREADED STUD



CAT150



| PART # | MATERIAL | LOOP SIZE | CAT5E CABLE CAPACITY | BOX QTY. |
|--------|-------------------|-----------|----------------------|----------|
| CAT150 | ZINC PLATED STEEL | 1-1/2" | 36 | 50 |
| CAT200 | | 2" | 71 | 50 |
| CAT400 | | 4" | 250 | 25 |

FEATURES

- Provides a smooth surface for cables
- 1" approximate stud length

APPLICATION

- Overhead 1/4"-20 stud mount G-Hook cable supports can be attached to a wide variety of overhead surfaces and are a cost effective alternative to J-Hooks
- G-Hooks provide support to sensitive voice and data cables without causing stress

MATERIAL/FINISH

- Steel/Zinc plated

LOW VOLTAGE CABLE MANAGEMENT



WOOD THREADED BRIDLE RINGS



4BRT32WSTZ

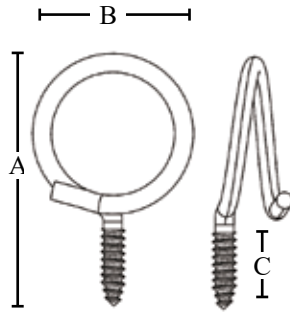

FEATURES

- Available in multiple ring diameters
- Wood screw threads allow rings to be screwed into wood surfaces

APPLICATION

- Threaded bridle rings are used to support communication cables and other low voltage wires
- Southwire bridle rings allow a quick and inexpensive way to support non data sensitive wires and cables from structural members

MATERIAL/FINISH

- Steel/Galvanized

CERTIFICATIONS

- UL Standard: UL 2239



| PART # | DIAMETER | THREAD | CAT5E CABLE CAPACITY | A | B | C | BOX QTY. |
|--------------|----------|--------|----------------------|-------|-------|-------|----------|
| BR-100-WS* | 1" | #14 | 20 | 2.72" | 1.65" | .512" | 100 |
| 4BRT20WSTZ** | 1-1/4" | #14 | 30 | 2.60" | 1.65" | .512" | 100 |
| BR-150-WS* | 1-1/2" | #14 | 42 | 3.22" | 1.91" | .512" | 100 |
| 4BRT32WSTZ** | 2" | #14 | 73 | 3.70" | 2.42" | .571" | 100 |

*UL listed | **cULus listed



MACHINE THREADED BRIDLE RINGS



4BRT20TZ



BR-501024



BR-125-SS

FEATURES

- Available in multiple ring diameters
- Machine screw threads allow rings to be screwed into other fasteners and clamps

APPLICATION

- Threaded bridle rings are used to support communication cables and other low voltage wires
- Southwire bridle rings allow a quick and inexpensive way to support non data sensitive wires and cables from structural members

MATERIAL/FINISH

- Steel/Galvanized or 316 Stainless steel

CERTIFICATIONS

- UL Standard: UL 2239

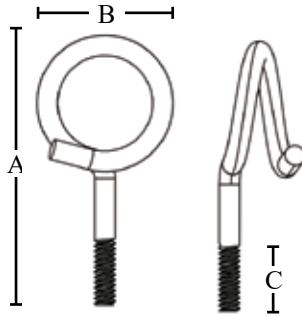

| PART # | MATERIAL | DIAMETER | THREAD SIZE | CAT5E CABLE CAPACITY | A | B | C | BOX QTY. |
|-------------|---------------------|----------|-------------|----------------------|-------|-------|-------|----------|
| BR-501024* | ZINC PLATED STEEL | 1/2" | #10 - 24 | 5 | 2.11" | 1.06 | .512" | 100 |
| 2BRT12TZ** | | 3/4" | #10 - 24 | 10 | 1.97" | 1.10" | .512" | 100 |
| BR-1001024* | | 1" | #10 - 24 | 20 | 2.72" | 1.65" | .512" | 100 |
| 2BRT20TZ** | | 1-1/4" | #10 - 24 | 30 | 2.62" | 1.57" | .512" | 100 |
| BR-1501024* | | 1-1/2" | #10 - 24 | 42 | 3.22" | 1.91" | .512" | 100 |
| 2BRT32TZ** | | 2" | #10 - 24 | 73 | 3.31" | 2.46" | .571" | 100 |
| 4BRT20TZ** | | 1-1/4" | 1/4" - 20 | 30 | 2.74" | 1.65" | .512" | 100 |
| BR-150* | | 1-1/2" | 1/4" - 20 | 42 | 3.22" | 1.91" | .512" | 100 |
| 4BRT32TZ** | | 2" | 1/4" - 20 | 73 | 2.56" | 3.57" | .571" | 100 |
| 4BRT64TZ** | | 4" | 1/4" - 20 | 250 | 6.51" | 4.45" | .689" | 50 |
| BR-125-SS | 316 STAINLESS STEEL | 1-1/4" | 1/4" - 20 | 30 | 2.60" | 1.65" | .512" | 100 |
| BR-150-SS | | 1-1/2" | 1/4" - 20 | 42 | 3.22" | 1.91" | .512" | 100 |
| BR-200-SS | | 2" | 1/4" - 20 | 73 | 2.56" | 3.57" | .571" | 100 |
| BR-400-SS | | 4" | 1/4" - 20 | 250 | 6.51" | 4.45" | .689" | 50 |

*UL listed | **cULus listed

HANGING AND SUPPORT

METAL THREADED RINGS

WITH NONMETALLIC SADDLE



BR-150-WH



FEATURES

- Nonmetallic saddle support provides additional support under cable

APPLICATION

- Threaded bridle rings are used to support communication cables and other low voltage wires
- Southwire bridle rings allow a quick and inexpensive way to support non data sensitive wires and cables from structural members

MATERIAL/FINISH

- Steel/Zinc plated
- Plastic saddle

CERTIFICATIONS

- UL Listed

| PART # | MATERIAL | LOOP SIZE | LEG THREAD | CAT5E CABLE CAPACITY | BOX QTY. |
|-----------|-------------------|-----------|------------|----------------------|----------|
| BR-150-WH | ZINC PLATED STEEL | 1-1/2" | 1/4" - 20 | 42 | 100 |
| BR-200-WH | | 2" | 1/4" - 20 | 73 | 100 |
| BR-400-WH | | 4" | 1/4" - 20 | 250 | 25 |

WOOD THREADED RINGS

WITH NONMETALLIC SADDLE



BR-150-WHWS



FEATURES

- Nonmetallic saddle support provides additional support under cable

APPLICATION

- Threaded bridle rings are used to support communication cables and other low voltage wires
- Southwire bridle rings allow a quick and inexpensive way to support non data sensitive wires /and cables from structural members

MATERIAL/FINISH

- Steel/Zinc plated
- Plastic saddle

| PART # | MATERIAL | LOOP SIZE | CAT5E CABLE CAPACITY | BOX QTY. |
|-------------|-------------------|-----------|----------------------|----------|
| BR-150-WHWS | ZINC PLATED STEEL | 1-1/2" | 42 | 100 |
| BR-200-WHWS | | 2" | 73 | 100 |

SNAP-ON DATA SADDLE ONLY

FOR BRIDLE RINGS, NONMETALLIC



BRS150

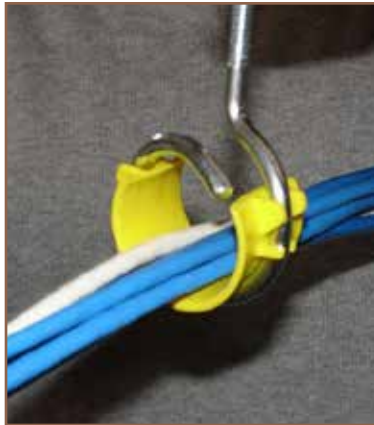

| PART # | MATERIAL | FITS RING SIZE | BOX QTY. |
|--------|---------------------|----------------|----------|
| BRS150 | PLENUM RATED SADDLE | 1-1/2" | 50 |
| BRS200 | | 2" | 50 |

FEATURES

- Snap-on design for quick installation
- Plenum Rated

APPLICATION

- Nonmetallic saddle support work with Southwire 1-1/2" and 2" bridle rings and provides additional support under cable

MATERIAL/FINISH

- Plastic/Yellow

CERTIFICATIONS

- UL Listed

BRIDLE RINGS, SCREW MOUNT LOOP HOLE



BR-150NP



| PART # | MATERIAL | LOOP SIZE | CAT5E CABLE CAPACITY | BOX QTY. |
|----------|-------------------|-----------|----------------------|----------|
| BR-150NP | ZINC PLATED STEEL | 1-1/2" | 42 | 100 |
| BR-200NP | | 2" | 73 | 100 |
| BR-400NP | | 4" | 250 | 50 |

FEATURES

- .26" diameter screw opening

APPLICATION

- Screw-mount loop hole mount bridle rings are used to support communication cables and other low voltage wires on overhead surface mount applications
- Southwire bridle rings allow a quick and inexpensive way to support non data sensitive wires and cables from structural members

MATERIAL/FINISH

- Steel/Zinc plated

CERTIFICATIONS

- UL Listed

HANGING AND SUPPORT

BRIDLE RINGS, QUICK-SHOT FOR STEEL OR CONCRETE

WITH NONMETALLIC DATA SADDLE



BR-150-SSCWH

FEATURES

- Compatible with all powder and gas guns
- Pre-assembled ready to shoot
- Nonmetallic saddle support provides additional support under cable

APPLICATION

- "Quick-shot" mount bridle rings are used to support communication cables and other low voltage wires on overhead surface mount applications
- Southwire bridle rings allow a quick and inexpensive way to support non data sensitive wires and cables from structural members

MATERIAL/FINISH

- Steel/Zinc plated

| PART # | MATERIAL/ COLOR | LOOP SIZE | CAT5E CABLE CAPACITY | BOX QTY. |
|--------------|----------------------|-----------|-------------------------|-------------|
| BR-150-SSCWH | ZINC PLATED STEEL | 1-1/2" | 42 | 100 |
| BR-200-SSCWH | | 2" | 73 | 100 |

BRIDLE RINGS, HOLLOW-WALL MOUNT

WITH EXPANSION TOGGLE



BR-150-TW



FEATURES

- 3-1/2" long leg
- Pop-out toggle-wing to secure in place behind wall surface

APPLICATION

- Hollow wall mount bridle rings are used to support communication cables and other low voltage wires
- Southwire bridle rings allow a quick and inexpensive way to support non data sensitive wires and cables from structural members

MATERIAL/FINISH

- Steel/Zinc plated

CERTIFICATIONS

- UL Listed

| PART # | MATERIAL | LOOP SIZE | CAT5E CABLE CAPACITY | BOX QTY. |
|-----------|-------------------|-----------|-------------------------|-------------|
| BR-150-TW | ZINC PLATED STEEL | 1-1/2" | 42 | 50 |
| BR-200-TW | | 2" | 73 | 50 |
| BR-400-TW | | 4" | 250 | 25 |

BRIDLE RINGS

MAGNETIC MOUNT



BRM150-HD



BRM75WH

FEATURES

- Easy to mount

APPLICATION

- Magnetic mount bridle rings are used to support communication cables and other low voltage wires on metal surface mount applications
- Southwire bridle rings allow a quick and inexpensive way to support non data sensitive wires and cables from structural members

MATERIAL/FINISH

- Steel/Zinc plated

| PART # | MATERIAL/COLOR | LOOP SIZE | CAT5E CABLE CAPACITY | PULL-OUT STRENGTH | BOX QTY. |
|-----------|----------------------|-----------|----------------------|-------------------|----------|
| BRM75BK | STEEL, PAINTED BLACK | 3/4" | 10 | 15 LBS. | 100 |
| BRM75WH | STEEL, PAINTED WHITE | 3/4" | 10 | 15 LBS. | 100 |
| BRM100BK | STEEL, PAINTED BLACK | 1" | 20 | 15 LBS. | 100 |
| BRM100WH | STEEL, PAINTED WHITE | 1" | 20 | 15 LBS. | 100 |
| BRM125BK | STEEL, PAINTED BLACK | 1-1/4" | 30 | 15 LBS. | 100 |
| BRM125WH | STEEL, PAINTED WHITE | 1-1/4" | 30 | 15 LBS. | 100 |
| BRM150-HD | ZINC PLATED STEEL | 1-1/2" | 42 | 90 LBS. | 50 |
| BRM200-HD | | 2" | 73 | 90 LBS. | 50 |
| BRM400-HD | | 4" | 250 | 90 LBS. | 50 |

DISTRIBUTION RINGS

SURFACE MOUNT, METALLIC



DST-200

FEATURES

- Distribution rings have a smooth surface that prevents cables from being damaged
- .22" diameter mounting holes

APPLICATION

- Distribution rings are used when support for multiple vertical or horizontal cable runs is required on walls or ceilings

MATERIAL/FINISH

- Aluminum
- Steel/Zinc plated

| PART # | MATERIAL | CABLE I.D. | CAT5E CABLE CAPACITY | BOX QTY. |
|----------|-------------------|------------|----------------------|----------|
| DST-200 | ALUMINUM | 2" | 75 | 50 |
| DST-300 | | 3" | 150 | 50 |
| DST-500 | | 5" | 250 | 25 |
| DST-800 | ZINC PLATED STEEL | 8" | 425 | 25 |
| DST-1200 | | 12" | 550 | 25 |

DISTRIBUTION RINGS, SURFACE MOUNT, METALLIC



17AB

| PART # | MATERIAL/COLOR | SUPPORT LOOP | BOX QTY. |
|--------|----------------------|-----------------|----------|
| 17AB | STEEL, PAINTED BLACK | 7/8" X 1-1/2" | 100 |
| 17BB | | 1" X 1-7/8" | 100 |
| 17CB | | 1-3/8" X 2-3/4" | 100 |

FEATURES

- Distribution rings have a smooth non-conductive surface that prevents cables from being damaged
- .175" diameter mounting holes

APPLICATION

- Support loop distribution rings are used when support for small cable runs is required on walls or communication boards and racks.
- Commonly used on communication back boards and other flat surfaces to sort and structure wires.

MATERIAL/FINISH

- Steel/Black paint

WIREBRACKET™ CABLE SUPPORT DEVICE NONMETALLIC



WB200



| PART # | MATERIAL | TRADE SIZE | BOX QTY. |
|--------|--------------|------------|----------|
| WB200 | NYLON, BLACK | 2" | 25 |

FEATURES

- Cable tie installation holes in each corner of ring to separate groups of cables
- Smooth interior surface
- Mounting holes accept tap cons, 1/4" bolts for beam clamps and light Hilti loads (1.5" nail with fender washer)
- MC does not require cable ties when 10 or less cables in ring

APPLICATION

- Dual purpose line voltage and low voltage cable support device for residential or commercial use

MATERIAL/FINISH

- Nylon/Black

CERTIFICATIONS

- UL Listed

DISTRIBUTION RINGS

SURFACE MOUNT, NONMETALLIC



DST-200-P

| PART # | MATERIAL | CABLE I.D. | CAT5E CABLE CAPACITY | BOX QTY. |
|-----------|--------------|------------|----------------------|----------|
| DST-200-P | GRAY PLASTIC | 2" | 75 | 50 |
| DST-300-P | | 3" | 150 | 50 |
| DST-500-P | | 5" | 250 | 25 |

FEATURES

- Distribution rings have a smooth surface that prevents cables from being damaged
- .21" diameter mounting holes

APPLICATION

- Distribution rings are used when support for multiple vertical or horizontal cable runs is required on walls or ceilings

MATERIAL/FINISH

- Plastic/Gray

OPEN DISTRIBUTION RINGS

SURFACE MOUNT, METALLIC



ODR-250

| PART # | MATERIAL | DIMENSIONS (H X W) | BOX QTY. |
|---------|-------------------|--------------------|----------|
| ODR-250 | DIE-CAST ALUMINUM | 2" X 2" | 50 |
| ODR-350 | | 1-1/2" X 3" | 50 |
| ODR-375 | | 3" X 3" | 50 |

FEATURES

- Distribution rings have a smooth surface that prevents cable damage
- .22" diameter mounting holes

APPLICATION

- Drop in/open style distribution rings are used when support is needed for cables that must remain accessible

MATERIAL/FINISH

- Aluminum/Die-Cast

BACKBOARD SPOOLS

NONMETALLIC ABS



WDS

| PART # | MOUNTING | DIMENSIONS | COLOR | BOX QTY. |
|--------|--------------------------|------------|-------|----------|
| WDS | MOUNTING HOLE ONLY | 2.91" TALL | IVORY | 100 |
| WDSWS | MOLDED IN WOOD SCREW | 2.91" TALL | GRAY | 100 |
| WDSMS | MOLDED IN WOOD SCREW *** | 2.91" TALL | BLACK | 100 |

FEATURES

- Smooth wire contact surface
- Sold with or without mounting screw

APPLICATION

- Wire distribution spools are used to neatly organize internal pairs or wires as they are being terminated on communication backboards and racks that are wood, steel or concrete

MATERIAL/FINISH

- Plastic/White

DRIVE RINGS, NAIL-ON MOUNT

GALVANIZED STEEL



DRV-1/2

| PART # | LOOP SIZE | CAT5E CABLE CAPACITY | BOX QTY. |
|-----------|-----------|----------------------|----------|
| DRV-1/2 | 1/2" | 5 | 50 |
| DRV-5/8 | 5/8" | 10 | 25 |
| DRV-7/8 | 7/8" | 30 | 25 |
| DRV-1-1/4 | 1-1/4" | 65 | 25 |
| DRV-1-1/2 | 1-1/2" | 90 | 25 |

FEATURES

- Smooth wire contact surface
- .21" diameter mounting holes

APPLICATION

- Drive rings are used to support communication cables and other low voltage wires
- Quick nail on drive rings with looped harness saves time and provides a very economical support in wet or dry locations
- Drive rings may also be used on wood surfaces or with beam clamps that accept drive pins

MATERIAL/FINISH

- Steel/Galvanized

DRIVE RINGS, WITH SCREW MOUNT LOOP HOLE

GALVANIZED STEEL



DRS-1/2

| PART # | SIZE | CAT5E CABLE CAPACITY | BOX QTY. |
|-----------|--------|----------------------|----------|
| DRS-1/2 | 1/2" | 5 | 50 |
| DRS-5/8 | 5/8" | 10 | 25 |
| DRS-7/8 | 7/8" | 30 | 25 |
| DRS-1-1/4 | 1-1/4" | 65 | 25 |
| DRS-1-1/2 | 1-1/2" | 90 | 25 |

FEATURES

- Smooth wire contact surface
- Screw-on drive rings work with most common drywall screws and threaded fasteners

APPLICATION

- Screw-on drive rings are used to support and secure wires and cables in tight spaces where hammer-on drive rings will not work

MATERIAL/FINISH

- Steel/Galvanized

CLIPS



MULTI-PURPOSE SUPPORT CLIP



2FMP28TZ

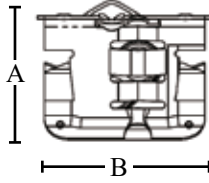

| PART # | A | B | C | BOX QTY. |
|----------|------|------|------|----------|
| 2FMP28TZ | 1.44 | 1.62 | .618 | 100 |

FEATURES

- Hammer-on attachment
- Fits flanges from 1/8" to 1/2"
- Accommodates 1/4" – 20 or #10 – 24 threaded bridle rings

APPLICATION

- Attaches to flanges to provide an anchor for bridle rings and other hardware

MATERIAL/FINISH

- Spring Steel/GEOSEAL™

CERTIFICATIONS

- UL Standard: UL 2239



TRAY CLIP



KBTTZ

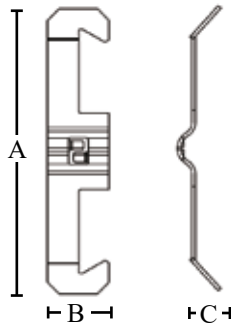

| PART # | A | B | C | BOX QTY. |
|--------|-------|-------|-------|----------|
| KBTTZ | 2.90" | .626" | .295" | 100 |

No load rating, for positioning only.

FEATURES

- Easy no-tool installation
- Supports 3/16" to 5/16" wire

APPLICATION

- Tray Clips attach cable management trays to struts
- Use two clips per strut for a 12" basket and for each additional 6" add another clip

MATERIAL/FINISH

- Spring Steel/GEOSEAL™

CERTIFICATIONS

- UL Standard: UL 2239



ACOUSTICAL/ CEILING

**Fittings that help position electrical
networks to the T-Grid structure**

ELECTRICAL SUPPORT SYSTEM

FIXTURE SUPPORTS

ELECTRICAL SUPPORT SYSTEMS



THREADED T-GRID CLIP

BOTTOM MOUNT



ATA4ITZ

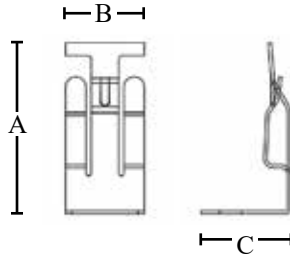

| PART # | A | B | C | BOX QTY. |
|---------|-------|-------|-------|----------|
| ATA4ITZ | 2.14" | .984" | 1.12" | 100 |

No load rating, for positioning only. Additional support required per NEC 300.11.

FEATURES

- Easy no-tool installation
- 1/4" threaded hole

APPLICATION

- Threaded T-Grid Clips attach to acoustical T-Bar to provide a method of securing boxes, conduit, or bridle rings

MATERIAL/FINISH

- Spring Steel/GEOSEAL™

CERTIFICATIONS

- UL Standard: UL 2239



THREADED T-GRID CLIP

SIDE MOUNT



ATS4ITZ

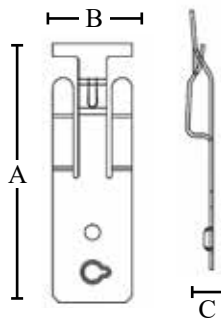

| PART # | A | B | C | BOX QTY. |
|---------|------|------|------|----------|
| ATS4ITZ | 3.20 | .984 | .374 | 100 |

No load rating, for positioning only. Additional support required per NEC 300.11.

FEATURES

- Easy no-tool installation
- 1/4" threaded hole
- Side mount method of hardware attachment

APPLICATION

- Threaded T-Grid Clip attaches to acoustical T-Bar for mounting of boxes, conduit, or bridle rings

MATERIAL/FINISH

- Spring Steel/GEOSEAL™

CERTIFICATIONS

- UL Standard: UL 2239



CONDUIT TO T-GRID SNAP CLAMPS



812MATATZ

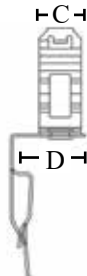
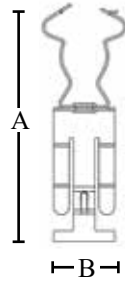

FEATURES

- Easy no-tool installation
- 360° rotating clip
- Top and side mounting available
- Attaches conduit or MC/AC cable to T-Grid

APPLICATION

- Conduit to T-Grid Clamps provide a fast and easy solution to position conduit or MC/AC cables above T-Grids
- Side mount option allows conduit attachment in both the horizontal and vertical directions

MATERIAL/FINISH

- Spring Steel/GEOSEAL™

CERTIFICATIONS

- UL Standard: UL 2239



| PART # | MOUNTING OPTION | CLIP CLOSURE | EMT SIZE | MC/AC SIZE | FMC SIZE | A | B | C | D | BOX QTY. |
|-----------|-----------------|--------------|-------------|-------------|----------|-------|-------|------|-------|----------|
| 6MATATZ | TOP | SNAP CLOSE | --- | 14-2 – 12-3 | 3/8" | 3.75" | .984" | .63" | 1.12" | 100 |
| 812MATATZ | TOP | SNAP CLOSE | 1/2" & 3/4" | --- | --- | 4.19" | .984" | .63" | 1.12" | 100 |

No load rating, this item is for component positioning only. Additional support required per NEC 300.11

CONDUIT TO T-GRID PUSH-IN CLIPS



8PATSTZ



CHPT-50

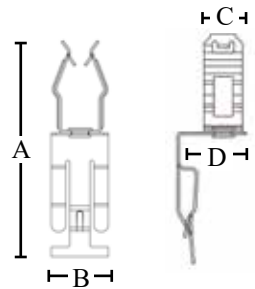
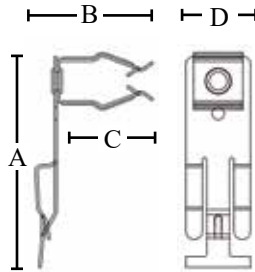

FEATURES

- Easy no-tool installation
- 360° rotating clip
- Top and side mounting available
- Attaches conduit or MC/AC cable to T-Grid

APPLICATION

- Push-in conduit hangers with T-Grid clip snap on the top edge of acoustical ceiling T-bar grid and provide a means of support for EMT conduit above the ceiling tiles

MATERIAL/FINISH

- Spring Steel/GEOSEAL™



| PART # | MOUNTING OPTION | EMT SIZE | A | B | C | D | BOX QTY. |
|------------|-----------------|----------|-------|-------|-------|-------|----------|
| 8PATSTZ* | SIDE | 1/2" | 3.20" | 1.74" | 1.46" | .984" | 100 |
| CHPT-50** | TOP | 1/2" | 3.71 | .984" | .748 | 1.12" | 50 |
| CHPT-75** | TOP | 3/4" | 3.81 | .984" | .748 | 1.12" | 50 |
| CHPT-100** | TOP | 1" | 4.09 | .984" | .748 | 1.12" | 50 |

No load rating, this item is for component positioning only. Additional support required per NEC 300.11

HEAVY DUTY T-GRID BOX HANGER



512HDTZ

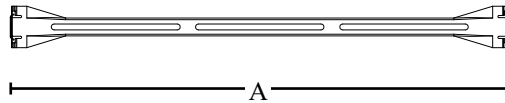

| PART # | STATIC LOAD (LBS.) | A | BOX QTY. |
|---------|--------------------|-----|----------|
| 512HDTZ | 50 | 24" | 25 |

FEATURES

- No tools required
- Mounts box flush with face of tile
- Mounts 1-1/2" deep box (break off tabs) or 2-1/8" deep box
- Includes mounting clip
- Easily attach drop wire for independent support directly to clip or bar
- Screws into T-Bar for added stability

APPLICATION

- Allows one or multiple electrical boxes to be quickly installed to T-Grid system
- Not for use with paddle fans

MATERIAL/FINISH

- Bar: Steel/Galvanized
- Clip: Spring Steel/GEOSEAL™

CERTIFICATIONS

- UL Standard: UL514A

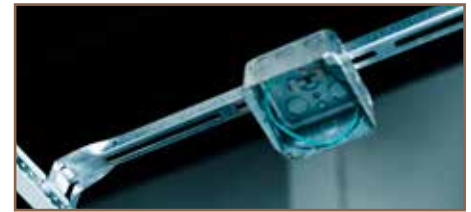

SNAP-ON T-GRID BOX HANGER



512TZ

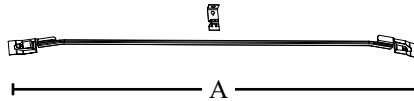

FEATURES

- Snap-on design
- Mounts 1-1/2" or 2-1/8" boxes to T-grids
- Box mounting clip and screw included (see Southwire part BHTC for replacement clip and screw)
- Boxes not included
- Galvanized steel

APPLICATION

- T-Grid brackets are used to mount boxes on ceiling T-bar grid. Fixed length box bar hangers are available for 1-1/2" or 2-1/8" deep boxes

MATERIAL/FINISH

- Bar: Steel/Galvanized
- Clip: Spring Steel/GEOSEAL™

CERTIFICATIONS

- cULus or UL Listed



| PART # | (A) LENGTH | HEIGHT ADJUSTMENT | STATIC LOAD (LBS.) | BOX QTY. |
|-----------|------------|-----------------------|-------------------------|----------|
| 512TZ* | 24" | NONE | 13 | 25 |
| BHT1A** | | 1/8" TO 8" ABOVE GRID | 20 | 50 |
| BHT481A** | 48" | 1/8" TO 8" ABOVE GRID | 13 | 25 |
| BHT1HD** | 24" | NONE | 50 (RESTRICTED BY GRID) | 25 |

*cULus Listed | **UL listed

Do not exceed static load without independent wire support to box mounting strap

BHT SERIES BAR HANGERS

CLIP AND SCREW SET



BHTC

FEATURES

- Includes clip and screw

APPLICATION

- Use to affix box to Southwire BHT series box support bars

MATERIAL/FINISH

- Steel/Galvanized

| PART # | DESCRIPTION | BOX QTY. |
|--------|---------------------------------------|----------|
| BHTC | CLIP AND SCREW, USE WITH BHT1 & BHT1A | 50 |

BH SERIES BAR HANGERS

REPLACEMENT CLIP AND SCREW SET



BHC

FEATURES

- Includes clip and screw

APPLICATION

- Use to affix box to Southwire bar hangers BH Series

MATERIAL/FINISH

- Steel/Galvanized

| PART # | DESCRIPTION | BOX QTY. |
|--------|----------------|----------|
| BHC | CLIP AND SCREW | 50 |

T-GRID CEILING 4" SQUARE BOX SLIDER SUPPORT BRACKET

24" LENGTH

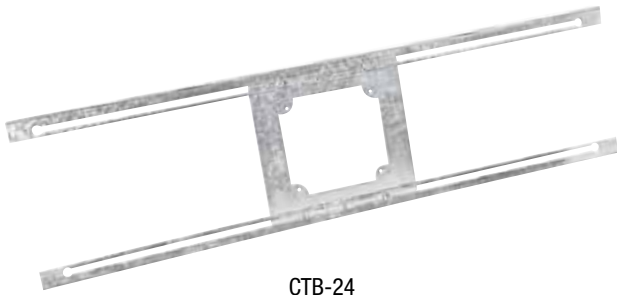

CTB-24

FEATURES

- Brackets rest on back side of ceiling tile and allow box to be installed at any position required
- Mounting plate accommodates all 4" boxes and covers
- "LK" suffix locking bracket design reduces movement due to vibration
- Some assemblies include boxes (see below)

APPLICATION

- Ceiling tile slider brackets are used to mount a variety of electrical and electronic components on ceiling grid tiles

MATERIAL/FINISH

- Steel/Galvanized

| PART # | DESCRIPTION | LOCKING TABS | BOX INCLUDED | BOX QTY. |
|-------------|---|--------------|--------------|----------|
| CTB-24 | ADJUST 4" BOX ANYWHERE ALONG 24" BRACKET | NO | --- | 20 |
| CTB-244S | ADJUST 4" BOX ANYWHERE ALONG 24" BRACKET WITH 4" SQUARE BOX | NO | 52181-S | 20 |
| CTB-24LK | ADJUST 4" BOX ANYWHERE ALONG LOCKING 24" BRACKET | YES | --- | 20 |
| 52181-VTBAR | 4" SQ, 3-1/2" DEEP BOX, HORZ. & VERT BRACKET ADJUSTMENT | SCREWS | 52181-VT | 10 |

T-GRID CEILING, 3" X 2" SWITCH BOX SUPPORT BRACKET



DCB

FEATURES

- Mounts anywhere along grid opening
- Switch box ears mount directly to bracket

APPLICATION

- Bracket is used to secure 3" x 2" switch box to T-Grid ceiling
- Perfect for mounting small life safety appliances, security camera or standard outlet

MATERIAL/FINISH

- Steel/Galvanized

| PART # | DESCRIPTION | BOX QTY. |
|--------|--|----------|
| DCB | SECURES 3" X 2" WITH EARS TO SECURE TO DROP CEILING GRID | 25 |

FIXTURE SUPPORTS



TWIST CLIP



4G16HTZ

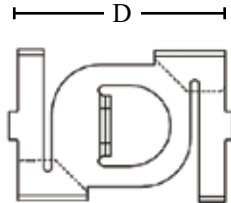
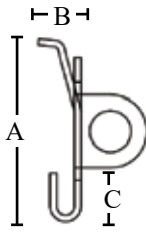

FEATURES

- Easy no-tool installation
- Plain hole

APPLICATION

- Twist clips are easily installed with no tools and provide a solution to support wire, hooks, or chains from T-Grids

MATERIAL/FINISH

- Spring Steel/GEOSEAL™

CERTIFICATIONS

- UL Standard: UL 2239



| PART # | T-GRID SIZE | SCREW LENGTH | HOLE SIZE | STATIC LOAD (LBS.) | A | B | C | D | BOX QTY. |
|---------|-------------|--------------|--------------|--------------------|--------|------|-------|-------|----------|
| 4G16HTZ | 15/16" | 9/16" | 1/4" – PLAIN | 40 | 1.094" | .65" | .433" | 1.60" | 100 |

TWIST CLIP WITH WING NUT



4G16TZ

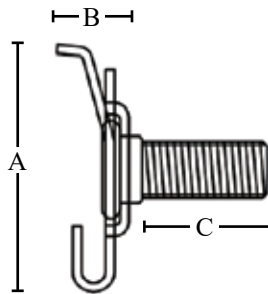

FEATURES

- Easy no-tool installation
- Wing Nut included

APPLICATION

- Twist clips with wing nut are designed to support electrical fixtures from T-Grids and are easily installed with no tools

MATERIAL/FINISH

- Spring Steel/GEOSEAL™

CERTIFICATIONS

- UL Standard: UL 2239



| PART # | T-GRID SIZE | SCREW LENGTH | THREAD SIZE | STATIC LOAD (LBS.) | A | B | C | BOX QTY. |
|--------|-------------|--------------|-------------|--------------------|-------|-------|-------|----------|
| 4G16TZ | 15/16" | 9/16" | 1/4" – 20 | 50 | 1.09" | .256" | .728" | 100 |

LIGHT FIXTURE CLIP



515ATZ

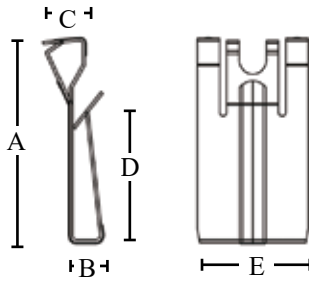

| PART # | A | B | C | D | E | BOX QTY. |
|--------|-------|-------|-------|-------|-------|----------|
| 515ATZ | 1.81" | .291" | .371" | 1.34" | .984" | 100 |

FEATURES

- Easy no-tool installation

APPLICATION

- The Light Fixture Clip provides a method for securing troffers, lay-in fixtures along with air diffusers

MATERIAL/FINISH

- Spring Steel/GEOSEAL™

CERTIFICATIONS

- UL Standard: UL 2239



FIXTURE TO T-GRID CLIP



IDSTZ

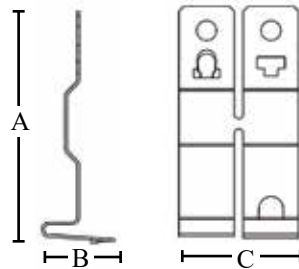

| PART # | T-GRID SIZE | STATIC LOAD (LBS.) | A | B | C | BOX QTY. |
|--------|-------------|--------------------|-------|-------|-------|----------|
| IDSTZ | 15/16" | 65 | 3.10" | .979" | .748" | 100 |

FEATURES

- Easy no-tool installation
- Includes mounting hardware

APPLICATION

- Clips easily to T-Grid with no tools to support fixtures

MATERIAL/FINISH

- Spring Steel/GEOSEAL™

CERTIFICATIONS

- UL Standard: UL 2239



JACK CHAINS



770TZ

FEATURES

- 12 Gauge Steel

APPLICATION

- Support chain for hanging linear and high bay fixtures

MATERIAL/FINISH

- Steel/Zinc plated

| PART # | STATIC WORKING LOAD (LBS.) | PACK SIZE | INNER QTY. | MASTER QTY. |
|--------|----------------------------|--------------|------------|-------------|
| W-10 | 43 | 100 FT. BOX | 100 | 500 |
| 770TZ | 29 | 100 FT. ROLL | 100 | 400 |
| W-13 | 29 | 50 FT. BOX | 50 | 500 |

S-HOOKS



W-11

APPLICATION

- Use to attach accessories to Jack Chain

MATERIAL/FINISH

- Steel/Zinc plated

| PART # | SIZE | STATIC LOAD (LBS.) | INNER QTY. | MASTER QTY. |
|--------|--------|--------------------|------------|-------------|
| 300 | 1" | 16 | 100 | 1000 |
| 300A | 1-1/4" | 29 | 100 | 1000 |
| 300B | 1-1/2" | 43 | 100 | 1000 |
| W-11 | 3" | 50 | 100 | 1000 |



Southwire™

HANGING & SUPPORT CATALOG

GET SOCIAL WITH US:



/SOUTHWIRETOOLS
/SOUTHWIRETOOLSLATINO



@SOUTHWIRETOOLS



@SOUTHWIRETOOLS



SOUTHWIRETOOLS

SOUTHWIRE.COM | 1-855-SWTOOLS

All Trademarks or Registered Trademarks (TM/®) are owned or licensed by Southwire Company.
Any other TM/® - Trademark or Registered Trademark of Southwire Company.