



Southwire™

# WEATHERPROOF

CATALOG

**BUILT FOR DURABILITY.  
BUILT FOR RELIABILITY.  
BUILT FOR WORK.™**

[SOUTHWIRE.COM](http://SOUTHWIRE.COM)

# DIE CAST ALUMINUM BOXES

## SINGLE GANG BOXES

### 3 HOLE



WB1350



UL® Listed and 2011 NEC®  
NEMA® 3R Compliant  
NEMA FB 1

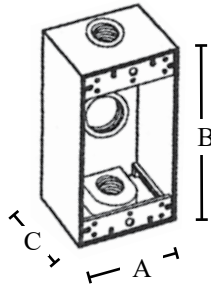

#### FEATURES

- 18 cubic inch capacity
- 1/2", 3/4" or 1" threaded hub
- Superior commercial quality die cast metal construction
- Boxes include 2 closure plugs, grounding screws and mounting lugs
- Installation instructions included
- Gray, bronze and white

#### APPLICATIONS

- UL listed for wet locations
- For wall or pole mounting of outdoor outlets, switches or floodlights

#### STANDARD MATERIAL

- Copper free aluminum

#### STANDARD FINISH

- Premium powder coat finish

PART #	THREADED HUB	COLOR	MASTER QTY.	WEIGHT/CASE (LBS.)	A	B	C
WB1350	1/2"	GRAY	25	15	2.81"	4.56"	2"
WB1350B	1/2"	BRONZE	25	15	2.81"	4.56"	2"
WB1350W	1/2"	WHITE	25	15	2.81"	4.56"	2"
WB1375	3/4"	GRAY	25	15	2.81"	4.56"	2"
WB1375B	3/4"	BRONZE	25	15	2.81"	4.56"	2"
WB1375W	3/4"	WHITE	25	15	2.81"	4.56"	2"
WB13100	1"	GRAY	25	13	2.81"	4.56"	2"

### 4 HOLE



WB1450



UL® Listed and 2011 NEC® and  
NEMA® 3R Compliant

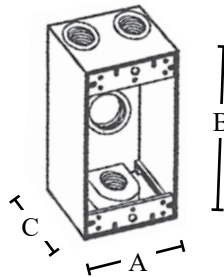

#### FEATURES

- 18 cubic inch capacity
- 1/2" or 3/4" threaded hub
- Superior commercial quality die cast metal construction
- Boxes include closure plugs, grounding screws and mounting lugs
- Installation instructions included
- Gray, bronze and white

#### APPLICATIONS

- UL listed for wet locations
- For wall or pole mounting of outdoor outlets, switches or floodlights

#### STANDARD MATERIAL

- Copper free aluminum

#### STANDARD FINISH

- Premium powder coat finish

PART #	THREADED HUB	COLOR	MASTER QTY.	WEIGHT/CASE (LBS.)	A	B	C
WB1450	1/2"	GRAY	25	14	2.81"	4.56"	2"
WB1450B	1/2"	BRONZE	25	14	2.81"	4.56"	2"
WB1450W	1/2"	WHITE	25	14	2.81"	4.56"	2"
WB1475	3/4"	GRAY	25	14	2.81"	4.56"	2"

WEATHERPROOF

# DIE CAST ALUMINUM BOXES

## SINGLE GANG BOXES

### 5 HOLE



WB1550



UL® Listed and 2011 NEC® and NEMA® 3R Compliant

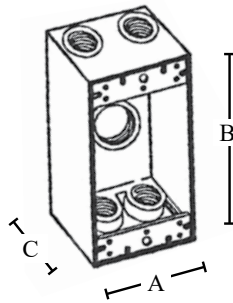

#### FEATURES

- 18 cubic inch capacity
- 1/2", 3/4" or 1" threaded hub
- Superior commercial quality die cast metal construction
- Boxes include closure plugs, grounding screws and mounting lugs
- Installation instructions included
- Gray

#### APPLICATIONS

- UL listed for wet locations
- For wall or pole mounting of outdoor outlets, switches or floodlights

#### STANDARD MATERIAL

- Copper free aluminum

#### STANDARD FINISH

- Premium powder coat finish

PART #	THREADED HUB	MASTER QTY.	WEIGHT/ CASE (LBS.)	A	B	C
WB1550	1/2"	25	13	2.81"	4.56"	2"
WB1575	3/4"	25	13	2.81"	4.56"	2"

### 5 HOLE SIDE OPENING



WB1550X



UL® Listed and 2011 NEC® and NEMA® 3R Compliant

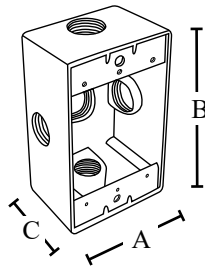

#### FEATURES

- 18 cubic inch capacity
- 1/2", 3/4" or 1" threaded hub
- Superior commercial quality die cast metal construction
- Boxes include closure plugs, grounding screws and mounting lugs
- Installation instructions included
- Gray

#### APPLICATIONS

- UL listed for wet locations
- For wall or pole mounting of outdoor outlets, switches or floodlights

#### STANDARD MATERIAL

- Copper free aluminum

#### STANDARD FINISH

- Premium powder coat finish

PART #	THREADED HUB	MASTER QTY.	WEIGHT/ CASE (LBS.)	A	B	C
WB1550X	1/2"	25	13	2.81"	4.56"	2"
WB1575X	3/4"	25	13	2.81"	4.56"	2"
WB15100X	1"	25	13	2.81"	4.56"	2"

WEATHERPROOF

# DIE CAST ALUMINUM BOXES

## SINGLE GANG BOXES

### 3 HOLE DEEP



WDB1350



UL® Listed and 2011 NEC® and NEMA® 3R Compliant

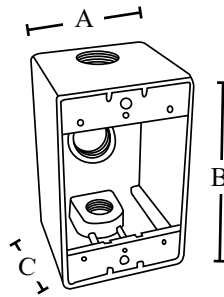

#### FEATURES

- 28 cubic inch capacity
- 1/2", 3/4" or 1" threaded hub
- Superior commercial quality die cast metal construction
- Boxes include closure plugs, grounding screws and mounting lugs
- Installation instructions included
- Gray, bronze and white

#### APPLICATIONS

- UL listed for wet locations
- For wall or pole mounting of outdoor outlets, switches or floodlights

#### STANDARD MATERIAL

- Copper free aluminum

#### STANDARD FINISH

- Premium powder coat finish

PART #	THREADED HUB	COLOR	MASTER QTY.	WEIGHT/CASE (LBS.)	A	B	C
WDB1350	1/2"	GRAY	20	16	2.81"	4.56"	2.62"
WDB1350B	1/2"	BRONZE	20	16	2.81"	4.56"	2.62"
WDB1350W	1/2"	WHITE	20	16	2.81"	4.56"	2.62"
WDB1375	3/4"	GRAY	20	16	2.81"	4.56"	2.62"
WDB1375B	3/4"	BRONZE	20	16	2.81"	4.56"	2.62"
WDB1375W	3/4"	WHITE	20	16	2.81"	4.56"	2.62"
WDB13100	1"	GRAY	20	16	2.81"	4.56"	2.62"

### 5 HOLE DEEP SIDE OPENING



WDB1550X



UL® Listed and 2011 NEC® and NEMA® 3R Compliant

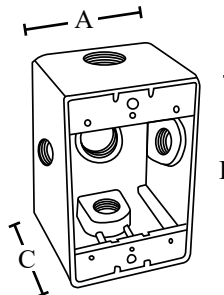

#### FEATURES

- 28 cubic inch capacity
- 1/2", 3/4" or 1" threaded hub
- Superior commercial quality die cast metal construction
- Boxes include closure plugs, grounding screws and mounting lugs
- Installation instructions included
- Gray

#### APPLICATIONS

- UL listed for wet locations
- For wall or pole mounting of outdoor outlets, switches or floodlights

#### STANDARD MATERIAL

- Copper free aluminum

#### STANDARD FINISH

- Premium powder coat finish

PART #	THREADED HUB	MASTER QTY.	WEIGHT/CASE (LBS.)	A	B	C
WDB1550X	1/2"	20	13	2.81"	4.56"	2.62"
WDB1575X	3/4"	20	13	2.81"	4.56"	2.62"
WDB15100X	1"	20	13	2.81"	4.56"	2.62"

WEATHERPROOF

# DIE CAST ALUMINUM BOXES DOUBLE GANG BOXES

## 3 HOLE



WB2350



UL® Listed and 2011 NEC® and NEMA® 3R Compliant

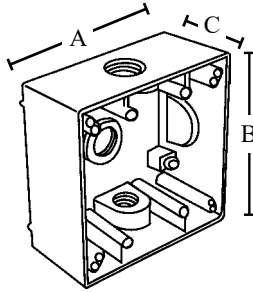

### FEATURES

- 31 cubic inch capacity
- 1/2", 3/4" or 1" threaded hub
- Superior commercial quality die cast metal construction
- Boxes include closure plugs, grounding screws and mounting lugs
- Installation instructions included
- Gray, bronze and white

### APPLICATIONS

- UL listed for wet locations
- For wall or pole mounting of outdoor outlets, switches or floodlights

### STANDARD MATERIAL

- Copper free aluminum

### STANDARD FINISH

- Premium powder coat finish

PART #	THREADED HUB	COLOR	MASTER QTY.	WEIGHT/CASE (LBS.)	A	B	C
WB2350	1/2"	GRAY	10	22	4.56"	4.56"	2"
WB2350B	1/2"	BRONZE	10	22	4.56"	4.56"	2"
WB2350W	1/2"	WHITE	10	22	4.56"	4.56"	2"
WB2375	3/4"	GRAY	10	22	4.56"	4.56"	2"
WB2375B	3/4"	BRONZE	10	22	4.56"	4.56"	2"
WB2375W	3/4"	WHITE	10	22	4.56"	4.56"	2"
WB23100	1"	GRAY	10	22	4.56"	4.56"	2"

## 4 HOLE



WB2450



UL® Listed and 2011 NEC® and NEMA® 3R Compliant

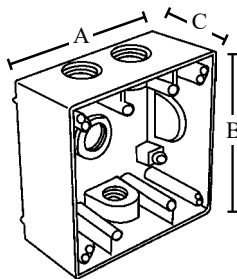

### FEATURES

- 31 cubic inch capacity
- 1/2" or 3/4" threaded hub
- Superior commercial quality die cast metal construction
- Boxes include closure plugs, grounding screws and mounting lugs
- Installation instructions included
- Gray

### APPLICATIONS

- UL listed for wet locations
- For wall or pole mounting of outdoor outlets, switches or floodlights

### STANDARD MATERIAL

- Copper free aluminum

### STANDARD FINISH

- Premium powder coat finish

PART #	THREADED HUB	MASTER QTY.	WEIGHT/CASE (LBS.)	A	B	C
WB2450	1/2"	10	21	4.56"	4.56"	2"
WB2475	3/4"	10	21	4.56"	4.56"	2"

WEATHERPROOF

# DIE CAST ALUMINUM BOXES DOUBLE GANG BOXES

## 5 HOLE



WB2550



UL® Listed and 2011 NEC® and NEMA® 3R Compliant

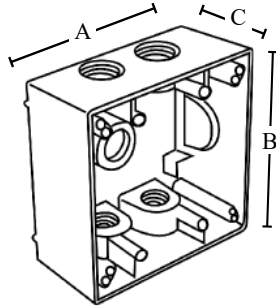

### FEATURES

- 31 cubic inch capacity
- 1/2" or 3/4" threaded hub
- Superior commercial quality die cast metal construction
- Boxes include closure plugs, grounding screws and mounting lugs
- Installation instructions included
- Gray

### APPLICATIONS

- UL listed for wet locations
- For wall or pole mounting of outdoor outlets, switches or floodlights

### STANDARD MATERIAL

- Copper free aluminum

### STANDARD FINISH

- Premium powder coat finish

PART #	THREADED HUB	MASTER QTY.	WEIGHT/ CASE (LBS.)	A	B	C
WB2550	1/2"	10	20	4.56"	4.56"	2"
WB2575	3/4"	10	20	4.56"	4.56"	2"

## 7 HOLE



WB2750



UL® Listed and 2011 NEC® and NEMA® 3R Compliant

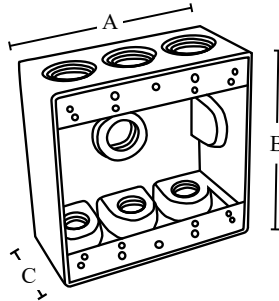

### FEATURES

- 31 cubic inch capacity
- 1/2" or 3/4" threaded hub
- Superior commercial quality die cast metal construction
- Boxes include closure plugs, grounding screws and mounting lugs
- Installation instructions included
- Gray

### APPLICATIONS

- UL listed for wet locations
- For wall or pole mounting of outdoor outlets, switches or floodlights

### STANDARD MATERIAL

- Copper free aluminum

### STANDARD FINISH

- Premium powder coat finish

PART #	THREADED HUB	MASTER QTY.	WEIGHT/ CASE (LBS.)	A	B	C
WB2750	1/2"	10	20	4.56"	4.56"	2"
WB2775	3/4"	10	20	4.56"	4.56"	2"

WEATHERPROOF

# DIE CAST ALUMINUM BOXES

## DOUBLE GANG BOXES

### 5 HOLE DEEP



WDB2550



UL® Listed and 2011 NEC® and NEMA® 3R Compliant

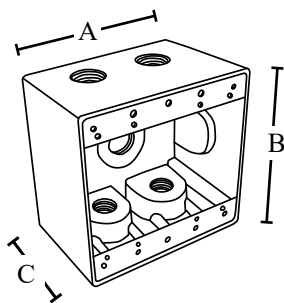

#### FEATURES

- 40 cubic inch capacity
- 1/2", 3/4" or 1" threaded hub
- Superior commercial quality die cast metal construction
- Boxes include closure plugs, grounding screws and mounting lugs
- Installation instructions included
- Gray

#### APPLICATIONS

- UL listed for wet locations
- For wall or pole mounting of outdoor outlets, switches or floodlights

#### STANDARD MATERIAL

- Copper free aluminum

#### STANDARD FINISH

- Premium powder coat finish

PART #	THREADED HUB	MASTER QTY.	WEIGHT/ CASE (LBS.)	A	B	C
WDB2550	1/2"	10	21	4.56"	4.56"	2.62"
WDB2575	3/4"	10	21	4.56"	4.56 "	2.62"
WDB25100	1"	10	21	4.56"	4.56"	2.62"

### 5 HOLE SIDE OPENING



WB2550X



UL® Listed and 2011 NEC® and NEMA® 3R Compliant

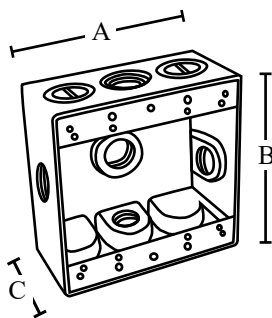

#### FEATURES

- 31 cubic inch capacity
- 1/2", 3/4" or 1" threaded hub
- Superior commercial quality die cast metal construction
- Boxes include closure plugs, grounding screws and mounting lugs
- Installation instructions included
- Gray

#### APPLICATIONS

- UL listed for wet locations
- For wall or pole mounting of outdoor outlets, switches or floodlights

#### STANDARD MATERIAL

- Copper free aluminum

#### STANDARD FINISH

- Premium powder coat finish

PART #	THREADED HUB	MASTER QTY.	WEIGHT/ CASE (LBS.)	A	B	C
WB2550X	1/2"	10	20	4.56"	4.56"	2"
WB2575X	3/4"	10	20	4.56"	4.56 "	2"
WB25100X	1"	10	20	4.56"	4.56"	2"

WEATHERPROOF

# DIE CAST ALUMINUM BOXES

## DOUBLE GANG BOXES

### 6 HOLE SIDE OPENING



WB2650X



UL® Listed and 2011 NEC® and NEMA® 3R Compliant

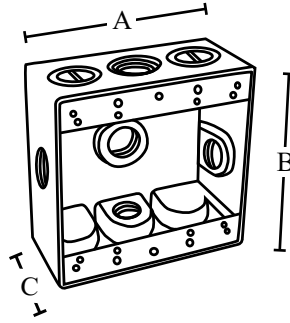

#### FEATURES

- 31 cubic inch capacity
- 1/2" or 3/4" threaded hub
- Superior commercial quality die cast metal construction
- Boxes include closure plugs, grounding screws and mounting lugs
- Installation instructions included
- Gray

#### APPLICATIONS

- UL listed for wet locations
- For wall or pole mounting of outdoor outlets, switches or floodlights

#### STANDARD MATERIAL

- Copper free aluminum

#### STANDARD FINISH

- Premium powder coat finish

PART #	THREADED HUB	MASTER QTY.	WEIGHT/ CASE (LBS.)	A	B	C
WB2650X	1/2"	10	19	4.56"	4.56"	2"
WB2675X	3/4"	10	19	4.56"	4.56 "	2"

### 7 HOLE SIDE OPENING



WB2775X



UL® Listed and 2011 NEC® and NEMA® 3R Compliant

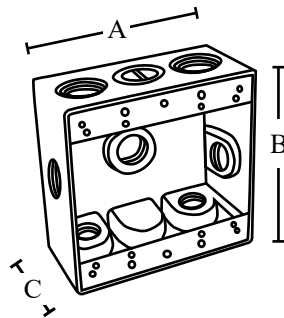

#### FEATURES

- 31 cubic inch capacity
- 1/2" or 3/4" threaded hub
- Superior commercial quality die cast metal construction
- Boxes include closure plugs, grounding screws and mounting lugs
- Installation instructions included
- Gray

#### APPLICATIONS

- UL listed for wet locations
- For wall or pole mounting of outdoor outlets, switches or floodlights

#### STANDARD MATERIAL

- Copper free aluminum

#### STANDARD FINISH

- Premium powder coat finish

PART #	THREADED HUB	MASTER QTY.	WEIGHT/ CASE (LBS.)	A	B	C
WB2750X	1/2"	10	19	4.56"	4.56"	2"
WB2775X	3/4"	10	19	4.56"	4.56 "	2"

WEATHERPROOF



# DIE CAST ALUMINUM BOXES TRIPLE GANG BOXES

## 7 HOLE



WB3750



UL® Listed and 2011 NEC® and  
NEMA® 3R Compliant

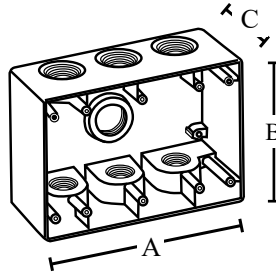

### FEATURES

- 54 cubic inch capacity
- 1/2", 3/4" or 1" threaded hub
- Superior commercial quality die cast metal construction
- Boxes include closure plugs, grounding screws and mounting lugs
- Installation instructions included
- Gray

### APPLICATIONS

- UL listed for wet locations
- For wall or pole mounting of outdoor outlets, switches or floodlights

### STANDARD MATERIAL

- Copper free aluminum

### STANDARD FINISH

- Premium powder coat finish

PART #	THREADED HUB	MASTER QTY.	WEIGHT/ CASE (LBS.)	A	B	C
WB3750	1/2"	5	11	6.374"	4.56"	2.625"
WB3775	3/4"	5	10	6.374"	4.56"	2.625"
WB37100	1"	5	9	6.374"	4.56"	2.625"

WEATHERPROOF

# DIE-CAST ALUMINUM COVERS

## SINGLE GANG COVERS

### 10 IN 1 VERTICAL & HORIZONTAL MULTI-USE COVER



WC1V12



UL® Listed and 2011 NEC® and NEMA® 3R Compliant

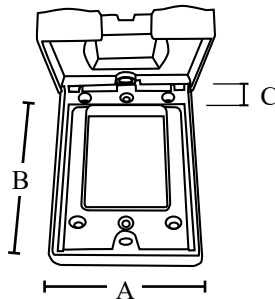

#### FEATURES

- Aluminum cast cover with spring loaded lid
- Can be mounted vertically or horizontally
- Heavy duty die cast metal construction
- Weather seal gasket to block moisture
- Roomy interior provides space for switches
- Lockable
- Snap in configuration enables tool free installation
- Maximum corrosion resistant fabrication
- Gray, bronze and white

#### APPLICATIONS

- UL listed for wet locations
- For use with single gang outdoor device box

#### STANDARD MATERIAL

- Precision die cast aluminum

#### STANDARD FINISH

- Premium powder coat finish

PART #	COLOR	MASTER QTY.	WEIGHT/ CASE	A	B	C
WC1V12	GRAY	20	22	2.81"	4.56"	.551"
WC1V12B	BRONZE	20	22	2.81"	4.56"	.551"
WC1V12W	WHITE	20	22	2.81"	4.56"	.551"

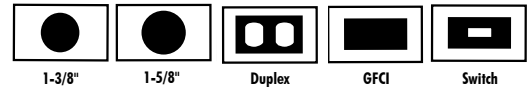
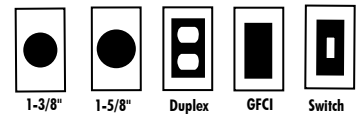

### 1 OR 3 HOLE RECTANGLE



WCR1150



WCR1350



UL® Listed and 2011 NEC® and NEMA® 3R Compliant

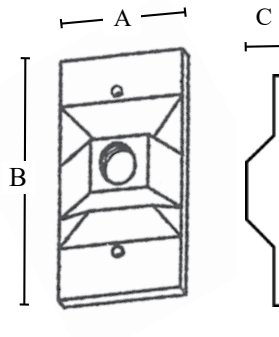

#### FEATURES

- 1 or 3 hole 1/2" threaded hub
- Includes gasket and screws
- Fits FS device boxes
- Superior commercial quality die cast metal construction
- Installation instructions included
- Gray, bronze and white

#### APPLICATIONS

- UL listed for wet locations
- Fits FS device boxes

#### STANDARD MATERIAL

- Copper free aluminum

#### STANDARD FINISH

- Premium powder coat finish

PART #	# OF HOLES	COLOR	THREADED HUB	MASTER QTY.	WEIGHT/ CASE (LBS.)	A	B	C
WCR1150	1	GRAY	1/2"	50	14	2.79 "	4.55"	.99"
WCR1150W	1	WHITE	1/2"	50	14	2.79 "	4.55"	.99"
WCR1350	3	GRAY	1/2"	50	14	2.79 "	4.55"	.99"
WCR1350B	3	BRONZE	1/2"	50	14	2.79 "	4.55"	.99"
WCR1350W	3	WHITE	1/2"	50	14	2.79 "	4.55"	.99"

WEATHERPROOF

# DIE-CAST ALUMINUM COVERS

## SINGLE GANG COVERS

### DUPLEX VERTICAL



WCV1DUP



UL® Listed and 2011 NEC® and NEMA® 3R Compliant

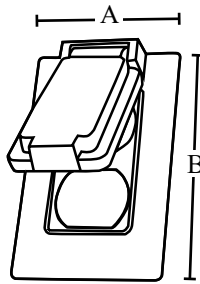

PART #	MASTER QTY.	WEIGHT/ CASE (LBS.)	A	B
WCV1DUP	50	25	2.81"	4.56"

#### FEATURES

- Aluminum cast cover with a spring loaded lid
- Weather seal gasket to block moisture
- Superior commercial quality die cast metal construction
- Installation instructions included
- Gray

#### APPLICATIONS

- UL listed for wet locations
- For use with single gang outdoor device box

#### STANDARD MATERIAL

- Precision die cast zinc

#### STANDARD FINISH

- Premium powder coat finish

### DUPLEX HORIZONTAL



WCH1DUPW



UL® Listed and 2011 NEC® and NEMA® 3R Compliant  
NEMA FB 1

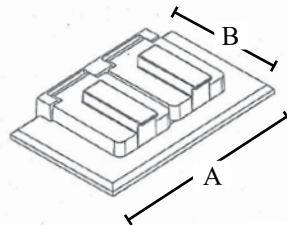

PART #	COLOR	MASTER QTY.	WEIGHT/ CASE (LBS.)	A	B
WCH1DUP	GRAY	50	35	4.56 "	2.81"
WCH1DUPB	BRONZE	50	35	4.56 "	2.81"
WCH1DUPW	WHITE	50	35	4.56 "	2.81"

#### FEATURES

- Heavy aluminum cast cover with a spring loaded lid
- Weather seal gasket to block moisture
- Superior commercial quality die cast metal construction
- Installation instructions included
- Gray, bronze or white

#### APPLICATIONS

- UL listed for wet locations
- Will fit all duplex receptacles in single outlet boxes

#### STANDARD MATERIAL

- Precision die cast aluminum

#### STANDARD FINISH

- Premium powder coat finish

WEATHERPROOF

# DIE-CAST ALUMINUM COVERS

## SINGLE GANG COVERS

### RECEPTACLE SWITCH



WCV11



UL® Listed and 2011 NEC® and NEMA® 3R Compliant

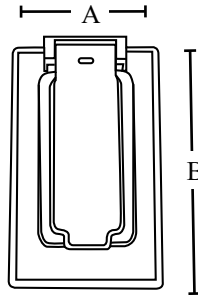

PART #	MASTER QTY.	WEIGHT/ CASE (LBS.)	A	B
WCV11	50	16	2.77"	4.52"

#### FEATURES

- Heavy aluminum die cast cover with a spring loaded lid
- Weather seal gasket to block moisture
- Superior commercial quality die cast metal construction
- Installation instructions included
- Gray

#### APPLICATIONS

- UL listed for wet locations
- Will fit 1.406" diameter receptacle in single outlet box

#### STANDARD MATERIAL

- Precision die cast aluminum

#### STANDARD FINISH

- Premium powder coat finish

### HORIZONTAL GFCI



WCH1GFI



UL® Listed and 2011 NEC® and NEMA® 3R Compliant

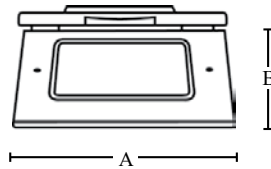

PART #	COLOR	MASTER QTY.	WEIGHT/ CASE (LBS.)	A	B
WCH1GFI	GRAY	50	20	4.56"	2.81"
WCH1GFIW	WHITE	50	20	4.56"	2.81"

#### FEATURES

- Heavy zinc die cast cover with a spring loaded lid
- Weather seal gasket to block moisture
- Superior commercial quality die cast metal construction
- Installation instructions included
- Gray and white

#### APPLICATIONS

- UL listed for wet locations
- For use with single gang outdoor device box

#### STANDARD MATERIAL

- Precision die cast zinc

#### STANDARD FINISH

- Premium powder coat finish

WEATHERPROOF

# DIE-CAST ALUMINUM COVERS

## SINGLE GANG COVERS

### VERTICAL GFCI



WCV1GR



UL® Listed and 2011 NEC® and NEMA® 3R Compliant

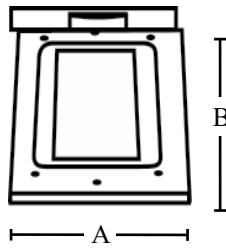

PART #	COLOR	MASTER QTY.	WEIGHT/ CASE (LBS.)	A	B
WCV1GFI	GRAY	50	20	2.81"	4.56"
WCV1GFW	WHITE	50	20	2.81"	4.56"

#### FEATURES

- Heavy zinc die cast cover with a spring loaded lid
- Weather seal gasket to block moisture
- Superior commercial quality die cast metal construction
- Installation instructions included
- Gray and white

#### APPLICATIONS

- UL listed for wet locations
- For use with single gang outdoor device box

#### STANDARD MATERIAL

- Precision die cast zinc

#### STANDARD FINISH

- Premium powder coat finish

### VERTICAL TOGGLE SWITCH HEAVY DUTY COVER



WSC1VHD



UL® Listed and 2011 NEC® and NEMA® 3R Compliant

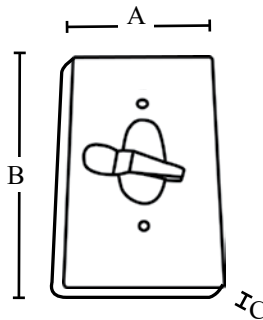

PART #	MASTER QTY.	WEIGHT/ CASE (LBS.)	A	B	C
WSC1VHD	25	7	2.81"	4.57"	.63"

#### FEATURES

- Designed to fit over a toggle light switch and mounted in a weatherproof box
- Weather seal gasket to block moisture
- Superior commercial quality die cast metal construction
- Installation instructions included
- Gray

#### APPLICATIONS

- UL listed for wet locations
- For use with single gang outdoor device box
- NEMA 3R compliant – resistant to rain, ice, and snow

#### STANDARD MATERIAL

- Precision die cast aluminum

#### STANDARD FINISH

- Premium powder coat finish

WEATHERPROOF

# DIE-CAST ALUMINUM COVERS

## SINGLE GANG COVERS

20A/30A RECEPTACLE  
30A/50A RECEPTACLE



WCV11.625



UL® Listed and 2011 NEC® and NEMA® 3R Compliant

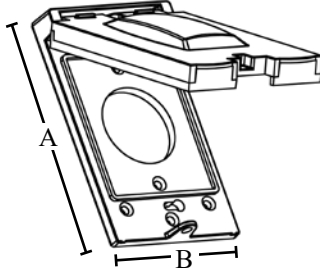

PART #	MASTER QTY.	WEIGHT/ CASE (LBS.)	A	B
WCV11.625	50	16	4.57"	2.80"
WCV12.125	50	16	4.57"	2.80"

### FEATURES

- Heavy aluminum die cast cover with a spring loaded lid
- Weather seal gasket to block moisture
- Superior commercial quality die cast metal construction
- Installation instructions included
- Gray

### APPLICATIONS

- UL listed for wet locations
- For use with single gang outdoor device box

### STANDARD MATERIAL

- Precision die cast aluminum

### STANDARD FINISH

- Premium powder coat finish

## BLANK



WC1B



UL® Listed and 2011 NEC® and NEMA® 3R Compliant

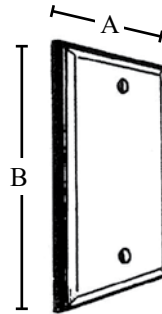

PART #	COLOR	MASTER QTY.	WEIGHT/ CASE (LBS.)	A	B
WC1B	SILVER	100	5	2.77"	4.54"
WC1BB	BRONZE	100	5	2.77"	4.54"
WC1BW	WHITE	100	5	2.77"	4.54"

### FEATURES

- Weather seal gasket to block moisture
- Installation instructions included
- Natural, bronze and white

### APPLICATIONS

- UL listed for wet locations
- For use with single gang outdoor device box

### STANDARD MATERIAL

- Natural - Stamped aluminum
- Bronze and White - Steel

WEATHERPROOF

# DIE-CAST ALUMINUM COVERS

## DOUBLE GANG COVERS

### DUPLEX



WCV2DUP



UL® Listed and 2011 NEC® and NEMA® 3R Compliant

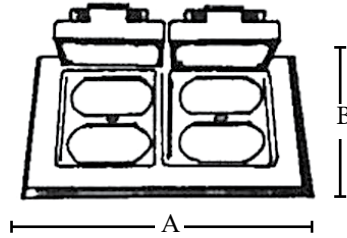

#### FEATURES

- Precision die cast zinc cover with a spring loaded lid
- Weather seal gasket to block moisture
- Superior commercial quality die cast metal construction
- Installation instructions included
- Gray

#### APPLICATIONS

- UL listed for wet locations
- For use with double gang outdoor device box

#### STANDARD MATERIAL

- Precision die cast zinc

#### STANDARD FINISH

- Premium powder coat finish

PART #	MASTER QTY.	WEIGHT/ CASE (LBS.)	A	B
WCV2DUP	25	15	4.54"	4.54"

### DUPLEX & SWITCH



WCV2SDUP



UL® Listed and 2011 NEC® and NEMA® 3R Compliant

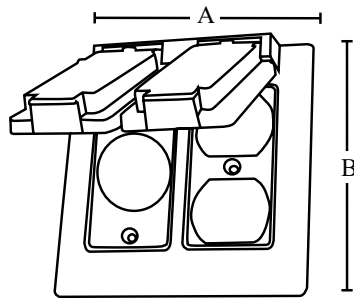

#### FEATURES

- Precision die cast zinc cover with a spring loaded lid
- Weather seal gasket to block moisture
- Superior commercial quality die cast metal construction
- Installation instructions included
- Gray

#### APPLICATIONS

- UL listed for wet locations
- For use with double gang outdoor device box

#### STANDARD MATERIAL

- Precision die cast zinc

#### STANDARD FINISH

- Premium powder coat finish

PART #	MASTER QTY.	WEIGHT/ CASE (LBS.)	A	B
WCV2SDUP	25	16	4.54"	4.54"

WEATHERPROOF

# DIE-CAST ALUMINUM COVERS

## DOUBLE GANG COVERS

### 15 AMP SWITCH



WCV21515



UL® Listed and 2011 NEC® and NEMA® 3R Compliant

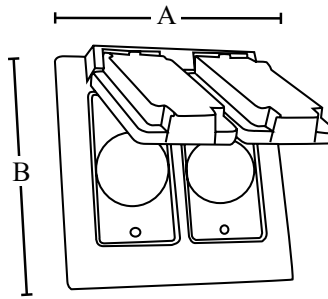

#### FEATURES

- Zinc cast cover with a spring loaded lid
- Opening diameter 1.406" (2)
- Weather seal gasket to block moisture
- Superior commercial quality die cast metal construction
- Installation instructions included
- Gray

#### APPLICATIONS

- UL listed for wet locations
- For use with double gang outdoor device box

#### STANDARD MATERIAL

- Precision die cast zinc

#### STANDARD FINISH

- Premium powder coat finish

PART #	MASTER QTY.	WEIGHT/ CASE (LBS.)	A	B
WCV21515	25	16	4.54"	4.54"

### 5 IN 1 COMBO COVER TOGGLE SWITCH



WC25GFI



UL® Listed and 2011 NEC® and NEMA® 3R Compliant

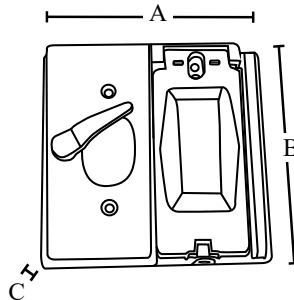

#### FEATURES

- Aluminum cast cover with a spring loaded lid with polycarbonate inserts
- Lockable design
- Pre-installed adhesive gasket
- Superior commercial quality die cast metal construction
- Installation instructions included
- NEMA 3R compliant
- Gray

#### APPLICATIONS

- UL listed for wet locations
- For use with double gang outdoor device box

#### STANDARD MATERIAL

- Copper free aluminum

#### STANDARD FINISH

- Premium powder coat finish

PART #	MASTER QTY.	WEIGHT/ CASE (LBS.)	A	B	C
WC25GFI	12	7	4.57"	4.63"	.63"

WEATHERPROOF



# DIE-CAST ALUMINUM COVERS DOUBLE GANG COVERS

## DUPLEX-GFCI



WCV2DUPGFI



UL® Listed and 2011 NEC® and  
NEMA® 3R Compliant

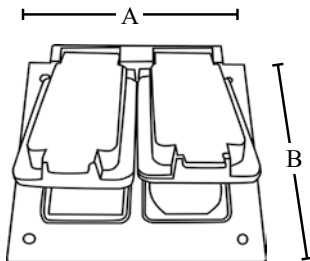

PART #	MASTER QTY.	WEIGHT/ CASE (LBS.)	A	B
WCV2DUPGFI	25	12	4.54"	4.54"

### FEATURES

- Die cast zinc cover with a spring loaded lid
- Weather seal gasket to keep moisture out
- Superior commercial quality die cast metal construction
- Installation instructions included
- Gray

### APPLICATIONS

- UL listed for wet locations
- For use with double gang outdoor device box

### STANDARD MATERIAL

- Precision die cast zinc

### STANDARD FINISH

- Premium powder coat finish

## VERTICAL-GFCI



WCV2GFI



UL® Listed and 2011 NEC® and  
NEMA® 3R Compliant

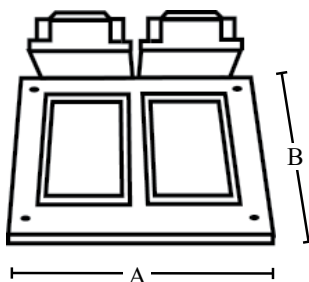

PART #	MASTER QTY.	WEIGHT/ CASE (LBS.)	A	B
WCV2GFI	50	35	4.54"	4.54"

### FEATURES

- Precision die cast zinc cover with a spring loaded lid
- Weather seal gasket to block moisture
- Superior commercial quality die cast metal construction
- Installation instructions included
- Gray

### APPLICATIONS

- UL listed for wet locations
- For use with double gang outdoor device box

### STANDARD MATERIAL

- Precision die cast zinc

### STANDARD FINISH

- Premium powder coat finish

WEATHERPROOF

# DIE-CAST ALUMINUM COVERS

## DOUBLE GANG COVERS

### TOGGLE SWITCH HEAVY DUTY



WSC22HD

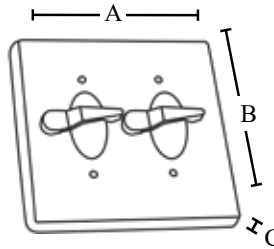

UL® Listed and 2011 NEC® and NEMA® 3R Compliant

#### FEATURES

- Designed to fit over a toggle light switch and mounted in a weatherproof box
- Polycarbonate inserts
- Weather seal gasket to block moisture
- Superior commercial quality die cast metal construction
- Installation instructions included
- NEMA 3R compliant
- Gray

#### APPLICATIONS

- UL listed for wet locations
- For use with double gang outdoor device box
- Can be used in NEMA 3R application (resistant to rain, ice, and snow)

#### STANDARD MATERIAL

- Precision die cast aluminum

#### STANDARD FINISH

- Premium powder coat finish

PART #	MASTER QTY.	WEIGHT/ CASE (LBS.)	A	B	C
WSC22HD	12	7	4.57"	4.63"	.63"

### 20/50 AMP POWER OUTLET



WCV22125

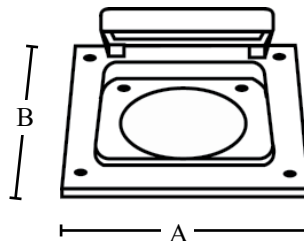

UL® Listed and 2011 NEC® and NEMA® 3R Compliant

#### FEATURES

- Aluminum cast cover with a spring loaded lid
- Weather seal gasket to block moisture
- Installation instructions included
- Gray

#### APPLICATIONS

- UL listed for wet locations
- For use with double gang outdoor device box

#### STANDARD MATERIAL

- Copper free aluminum

#### STANDARD FINISH

- Premium powder coat finish

PART #	MASTER QTY.	WEIGHT/ CASE (LBS.)	A	B	HOLE DIAMETER
WCV22125	8	7	4.54"	4.54"	2.125"
WCV2264	8	7	4.54"	4.54"	2.64"

WEATHERPROOF

# DIE-CAST ALUMINUM COVERS

## DOUBLE GANG COVERS

### 16 IN 1 VERTICAL MULTI-USE COVER



WC2225



UL® Listed and 2011 NEC® and NEMA® 3R Compliant

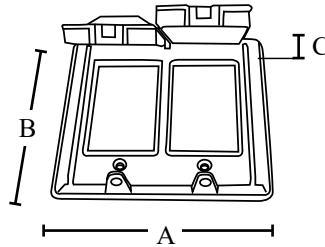

#### FEATURES

- Aluminum cast multi-use cover with spring loaded lid
- Weather seal gasket to block moisture
- Superior commercial quality die cast metal construction
- Installation instructions included
- Gray, bronze and white

#### APPLICATIONS

- UL listed for wet locations
- For receptacles in damp or wet locations
- For use with double gang outdoor device box

#### STANDARD MATERIAL

- Precision die cast aluminum

#### STANDARD FINISH

- Premium powder coat finish

PART #	COLOR	MASTER QTY.	WEIGHT/ CASE (LBS.)	A	B	C
WC2225	GRAY	10	17	4.56"	4.56"	.551"
WC2225B	BRONZE	10	17	4.56"	4.56"	.551"
WC2225W	WHITE	10	17	4.56"	4.56"	.551"

## BLANK



WC2B



UL® Listed and 2011 NEC® and NEMA® 3R Compliant

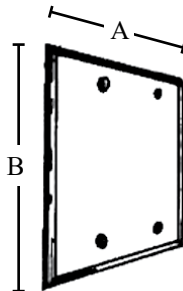

#### FEATURES

- Aluminum cast cover
- Weather seal gasket to block moisture
- Installation instructions included
- Superior commercial quality die cast metal construction
- Natural, bronze and white

#### APPLICATIONS

- UL listed for wet locations
- For use with double gang outdoor device box

#### STANDARD MATERIAL

- Natural - Stamped aluminum
- Bronze and White - Steel

PART #	COLOR	MASTER QTY.	WEIGHT/ CASE (LBS.)	A	B
WC2B	SILVER	100	11	4.62"	4.57"
WC2BB	BRONZE	100	11	4.62"	4.57"
WC2BW	WHITE	100	11	4.62"	4.57"

WEATHERPROOF

# DIE-CAST ALUMINUM COVERS

## TRIPLE GANG COVERS

### 64 IN 1 VERTICAL MULTI-USE COVER



WC3325



UL® Listed and 2011 NEC® and NEMA® 3R Compliant

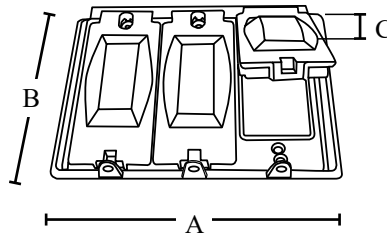

#### FEATURES

- Aluminum cast multi-use cover with a spring loaded lid
- Weather seal gasket to block moisture
- Installation instructions included
- Gray

#### APPLICATIONS

- UL listed for wet locations
- For use with triple gang outdoor device box

#### STANDARD MATERIAL

- Copper free aluminum

#### STANDARD FINISH

- Premium powder coat finish

PART #	MASTER QTY.	WEIGHT/ CASE (LBS.)	A	B	C
WC3325	5	6	6.338"	4.57"	.551"

## BLANK



WC3B



UL® Listed and 2011 NEC® and NEMA® 3R Compliant

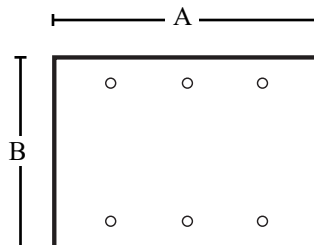

#### FEATURES

- Aluminum cast cover
- Weather seal gasket to block moisture
- Superior commercial quality die cast metal construction
- Installation instructions included
- Gray

#### APPLICATIONS

- UL listed for wet locations
- For use with triple gang outdoor device box
- NEMA 3R compliant – resistant to rain, ice and snow

#### STANDARD MATERIAL

- Natural - Stamped aluminum

PART #	MASTER QTY.	WEIGHT/ CASE (LBS.)	A	B
WC3B	20	8	6.338"	4.57"

WEATHERPROOF

# SINGLE GANG IN-USE COVERS - VERTICAL OR HORIZONTAL

## 14 IN 1 EXTRA DUTY IN-USE COVER



WCIU1



UL® Listed and 2011 NEC® and NEMA® 3R Compliant



PART #	MASTER QTY.	WEIGHT/ CASE (LBS.)	A	B	C DEPTH
WCIU1	24	11	2.81"	4.56"	2.75"
WCIU1D	24	14	2.81"	4.56"	3.50"

14 possible snap in configurations

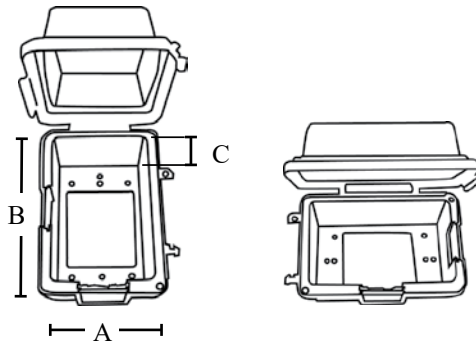
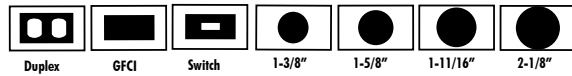
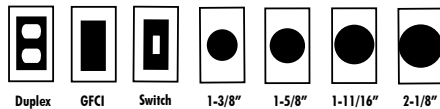

### FEATURES

- Mounts vertically or horizontally
- Pre-installed adhesive gasket
- Swivel device adapter enables tool free installation
- Snap in adapters enable tool free installation
- Lockable to prevent accidental disconnects
- Meets 2014 NEC article 406.8 (B) (1)
- NEMA 3R compliant
- Gray with clear cover

### APPLICATIONS

- UL listed for wet locations
- For use with duplex receptacles, GFCI, toggle, 1-3/8" & 1-5/8" round

### STANDARD MATERIAL

- High impact polycarbonate

## 16 IN 1 EXTRA DUTY IN-USE SINGLE GANG COVER



WCIU1SD



NEMA 3R Rated,  
NEC 2014 compliant  
[article 406.9 (A) & (B)(1) "extra duty"]  
cULus-5FX8



16-1 snap in configurations

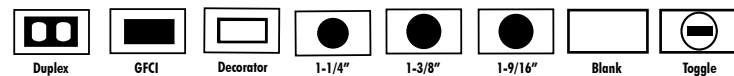
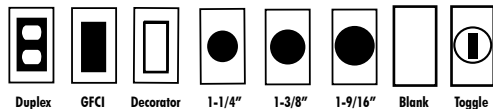

PART #	MASTER QTY.	WEIGHT/ CASE (LBS.)	A	B	C DEPTH
WCIU1SD	8	22	6"	4.60"	3.10"

### FEATURES

- Mounts vertically or horizontally
- Includes three inserts
- 16 Installation combinations
- Lockable
- Includes attached gasket and mounting hardware
- Adapters included for duplex and GFCI
- Fast mounting screw attachment
- Super duty hinge system
- Compatible with full size padlocks
- Patent pending extra-duty hinge system

### APPLICATION

- UL listed for wet locations
- Use when an outdoor outlet requires weatherproof protection for both residential and commercial applications

### STANDARD MATERIAL

- High impact polycarbonate

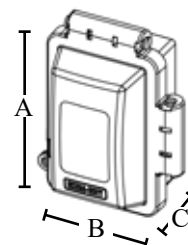

WEATHERPROOF

# SINGLE GANG IN-USE COVERS

## 7 IN 1 METAL EXTRA DUTY IN-USE COVER



WCIU1VM



UL® Listed and 2011 NEC® and NEMA® 3R Compliant

Meets and exceeds extra duty per 2011 NEC article 406.9.(B);

UL 514D and CSA 22.2 No. 42-1-00

NEMA 3R Rating Compliant:

UL standard 514D, cULus Listed, E25-4321

Fed. Spec. A-A-50563

NEMA FB 1

PART #	OPENING	MASTER QTY.	WEIGHT/ CASE (LBS.)	A	B	C DEPTH
WCIU1VM	2.75-3.50	10	11	4.61"	3.07"	2.39"
WCIU1HM	2.75-3.50	10	11	2.83"	4.6"1	2.39"

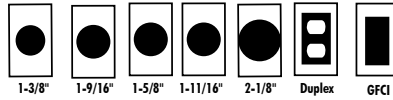
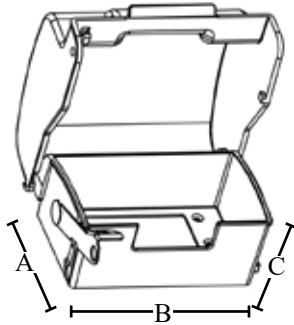

### FEATURES

- Low profile multi height metal extra duty in-use cover
- Impact rated, withstands today's destructive forces
- Reinforced hinge withstands 40 lbs. stress test
- Lockable to prevent accidental disconnects
- Patent snap in adapters enables tool free installation
- Swing bar up or down for patent multi height position
- Expands out to 3-1/2" to gain extra clearance and accommodate internal cords
- Sleek industrial design
- Easy to open
- Extra large cord opening for heavy gauge cords

### APPLICATIONS

- UL listed for wet locations
- Extra duty metal in use covers are designed for use whenever weatherproof protection is required while an outlet is in use
- Provides superior protection for industrial, commercial and residential electrical receptacles

### STANDARD MATERIAL

- Copper free aluminum

### STANDARD FINISH

- Premium powder coat finish

WEATHERPROOF

# DOUBLE GANG IN-USE COVERS

## 31 IN 1 EXTRA DUTY IN USE COVER



WCIU2



UL® Listed and 2011 NEC® and NEMA® 3R Compliant

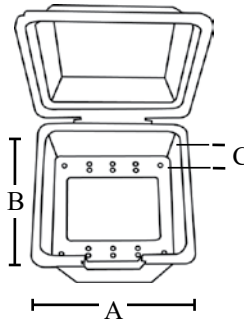

### FEATURES

- Mounts vertically
- Pre-installed adhesive gasket
- Swivel device adapter enables tool free installation
- Snap in adapters enable tool free installation
- Meets 2014 NEC article 406.8 (B) (1)
- NEMA 3R compliant
- Gray with clear cover

### APPLICATIONS

- UL listed for wet locations
- For use with duplex receptacles, GFCI, toggle, 1-3/8" & 1-5/8" round

### STANDARD MATERIAL

- High impact polycarbonate

PART #	MASTER QTY.	WEIGHT/CASE (LBS.)	A	B	C DEPTH
WCIU2	10	10	4.40"	4.54"	3.50"

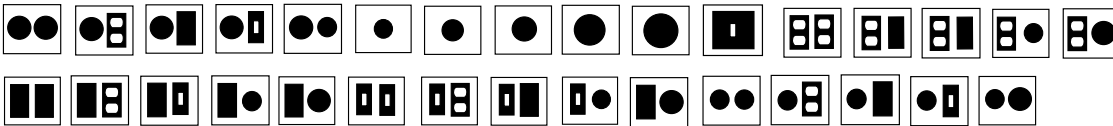

## ADD 73 IN 1 EXTRA DUTY IN-USE COVER



WCIU2SD



NEMA 3R Rated, NEC 2014 compliant [article 406.9 (A) & (B)(1) "extra duty"] cULus-5FX8

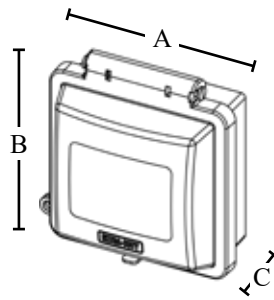

### FEATURES

- Includes 7 inserts
- 73 Installation combinations
- Lockable
- Includes attached gasket and mounting hardware
- Adapters included for duplex and GFCI
- Fast mounting screw attachment
- Compatible with full size padlocks
- Patent pending extra-duty hinge system

### APPLICATIONS

- UL listed for wet locations
- Use when an outdoor outlet requires weatherproof protection for both residential and commercial applications

### STANDARD MATERIAL

- High impact polycarbonate

PART #	MASTER QTY.	WEIGHT/CASE (LBS.)	A	B	C DEPTH
WCIU2SD	6	35	6"	6"	3.10"

Multiple combinations of Duplex, GFCI, Decorator, Blank toggle, Large toggle, 1-1/4", 1-3/8", 1-9/16", 1-5/8", 1-11/16", 2-1/8", 2-1/4", 2-7/16"

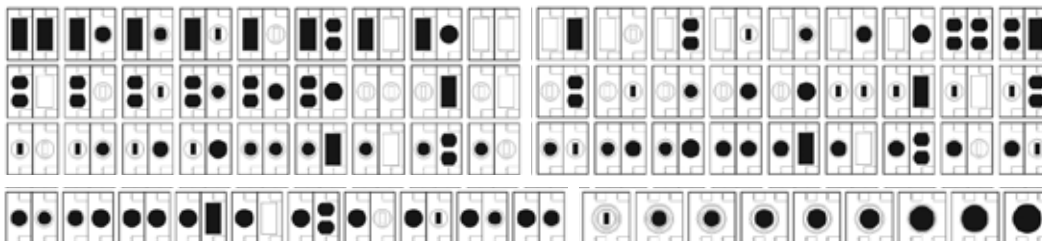

WEATHERPROOF

# DOUBLE GANG IN-USE COVERS

## 31 IN 1 METAL EXTRA DUTY IN-USE COVER



WCIU2M



UL® Listed and 2011 NEC® and NEMA® 3R Compliant

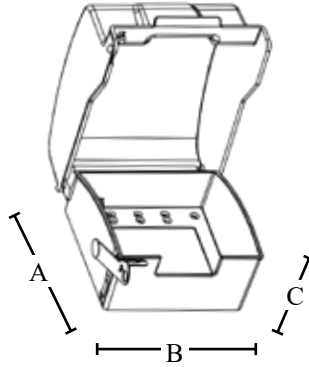

PART #	OPENING	MASTER QTY.	WEIGHT/ CASE (LBS.)	A	B	C DEPTH
WCIU2M	3.50-4.50	6	13	4.61"	4.61"	2.39"

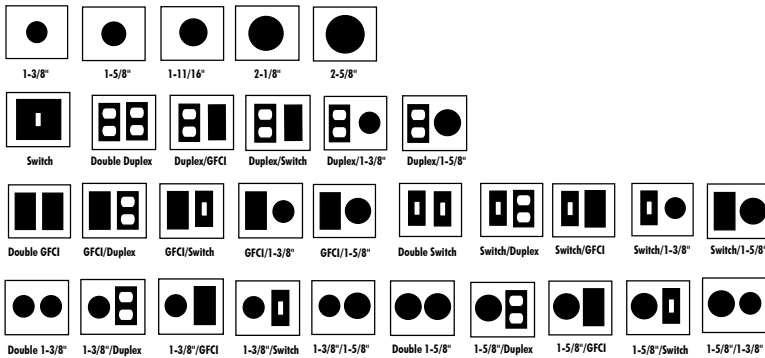

### FEATURES

- Low profile multi height metal extra duty in use cover
- Impact rated, withstands today's destructive forces
- Reinforced hinge withstands 40 lbs. stress test
- Lockable to prevent accidental disconnects
- Patent snap in adapters (no tools required)
- Swing bar up or down for patent multi height position
- Expands out to 4-1/2" to gain extra clearance and accommodate internal cords
- Sleek industrial design
- Easy to open
- Extra large cord opening for heavy gauge cords

### APPLICATIONS

- UL listed for wet locations
- Extra duty metal in use covers are designed for use whenever weatherproof protection is required while an outlet is in use
- Provides superior protection for industrial, commercial and residential electrical receptacles

### STANDARD MATERIAL

- Copper free aluminum

### STANDARD FINISH

- Premium powder coat finish

WEATHERPROOF



# ROUND COVERS

1, 2 OR 3 HOLE



WRC150



WRC350



WRC250



UL® Listed and 2011 NEC® and NEMA® 3R Compliant

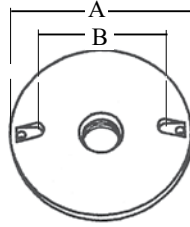

## FEATURES

- NPT threads
- Weather seal gasket blocks moisture
- Installation instructions included
- Gray, bronze and white

## APPLICATIONS

- UL listed for wet locations
- For use with round outdoor device box

## STANDARD MATERIAL

- Precision die cast aluminum

## STANDARD FINISH

- Premium powder coat finish

PART #	# HOLES	THREADED HUB	COLOR	MASTER QTY.	WEIGHT/ CASE (LBS.)	A	B	C
WRC150	1	1/2"	GRAY	50	9	4.50"	3.50"	8.75"
WRC150B*	1	1/2"	BRONZE	50	9	4.50"	3.50"	8.75"
WRC250	2	1/2"	GRAY	50	9	4.50"	3.50"	8.75"
WRC350	3	1/2"	GRAY	50	9	4.50"	3.50"	8.75"
WRC350B*	3	1/2"	BRONZE	50	9	4.50"	3.50"	8.75"
WRC150W**	1	1/2"	WHITE	50	9	4.50"	3.50"	8.75"
WRC250W**	2	1/2"	WHITE	50	10	4.50"	3.50"	8.75"
WRC350W**	3	1/2"	WHITE	50	10	4.50"	3.50"	8.75"

## BLANK



WRCB

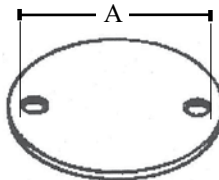

## FEATURES

- Weather seal gasket and screws to keep out moisture
- Will fit round outlet boxes
- Installation instructions included
- Natural finish

## APPLICATIONS

- UL listed for wet locations
- For use with round outdoor device box

## STANDARD MATERIAL

- Stamped aluminum

## APPLICABLE THIRD PARTY STANDARDS

- UL Standard: UL 514A - UL514D
- Fed. Spec: W-C-586D, AA-50563
- NEMA: FB 1-2014, NEMA 3R
- 2011 NEC®

PART #	MASTER QTY.	WEIGHT/ CASE (LBS.)	A
WRCB	50	8	4.08"

WEATHERPROOF

# 4" ROUND BOX

## 5 HOLE



WRB1550W



UL® Listed and 2011 NEC® and NEMA® 3R Compliant

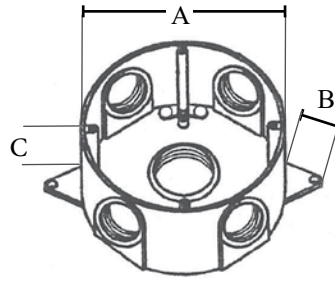

### FEATURES

- 17.2 cubic inch capacity
- Includes 4 closure plugs and grounding screws
- 1/2" or 3/4" threaded hub
- For wall or ceiling mounting
- Installation instructions included
- Gray, bronze and white

### APPLICATIONS

- UL listed for wet locations
- For use with all round outlet box and lampholder covers

### STANDARD MATERIAL

- Copper free aluminum

### STANDARD FINISH

- Premium powder coat finish

PART #	THREADED HUB	COLOR	MASTER QTY.	WEIGHT/ CASE (LBS.)	A	B	C DEPTH
WRB1550	1/2"	GRAY	25	14	4.31"	.65"	1.58"
WRB1550B	1/2"	BRONZE	25	14	4.31"	.65"	1.58"
WRB1550W	1/2"	WHITE	25	14	4.31"	.65"	1.58"
WRB1575	3/4"	GRAY	25	14	4.31"	.65"	1.58"
WRB1575W	3/4"	WHITE	25	14	4.31"	.65"	1.58"

# 4" ROUND EXTENSIONS

## 4 HOLE



WRB450EXT



UL® Listed and 2011 NEC® and NEMA® 3R Compliant

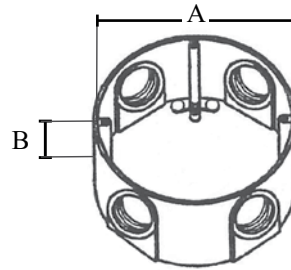

### FEATURES

- Corrosion resistant die cast construction
- 1/2" or 3/4" threaded hub
- Installation instructions included

### APPLICATIONS

- UL listed for wet locations
- Expands cubic capacity and enables flush finish

### STANDARD MATERIAL

- Copper free aluminum

PART #	THREADED HUB	MASTER QTY.	WEIGHT/ CASE (LBS.)	A	B
WRB450EXT	1/2"	10	6	4.31"	1.58"
WRB475EXT	3/4"	10	6	4.31"	1.58"

WEATHERPROOF

# SINGLE GANG EXTENSION

## RECTANGLE



WB1EXT

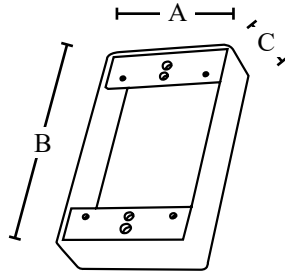

### FEATURES

- Installation instructions included
- Superior commercial quality die cast metal construction

### APPLICATIONS

- Expands cubic capacity and enables flush finish

### STANDARD MATERIAL

- Copper free aluminum

### STANDARD FINISH

- Premium powder coat finish

PART #	MASTER QTY.	WEIGHT/ CASE (LBS.)	A	B	C DEPTH
WB1EXT	25	6	2.81"	4.56"	1"

## 4 HOLE



WB1450EXT



UL® Listed and 2011 NEC® and NEMA® 3R Compliant

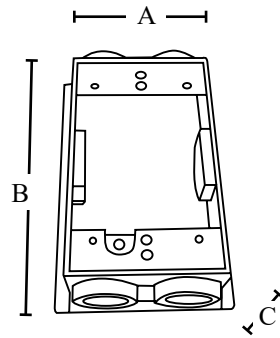

### FEATURES

- 1/2" or 3/4" threaded hub
- Installation instructions included

### APPLICATIONS

- UL listed for wet locations
- Expands cubic capacity and enables flush finish

### STANDARD MATERIAL

- Copper free aluminum

### STANDARD FINISH

- Premium powder coat finish

PART #	THREADED HUB	MASTER QTY.	WEIGHT/ CASE (LBS.)	A	B	C DEPTH
WB1450EXT	1/2"	25	18	3.464"	5.236"	1.575"
WB1475EXT	3/4"	25	16	3.464"	5.236"	1.575"

# SINGLE GANG EXTENSIONS

## 6 HOLE



WB1650EXT



UL® Listed and 2011 NEC® and NEMA® 3R Compliant

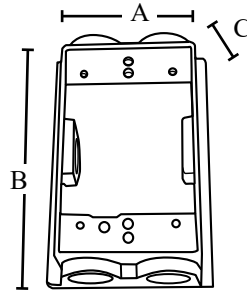

### FEATURES

- NPT threads
- 1/2" or 3/4" threaded hub
- Installation instructions included

### APPLICATIONS

- UL listed for wet locations
- Expands cubic capacity and enables flush finish

### STANDARD MATERIAL

- Copper free aluminum

### STANDARD FINISH

- Premium powder coat finish

PART #	THREADED HUB	MASTER QTY.	WEIGHT/ CASE (LBS.)	A	B	C
WB1650EXT	1/2"	25	16	3.464"	5.236"	1.575"
WB1675EXT	3/4"	25	14	3.464"	5.236"	1.575"

# DOUBLE GANG EXTENSION

## SQUARE



WB2EXT

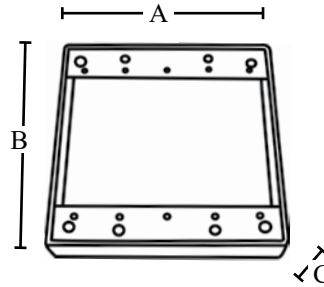

### FEATURES

- Installation instructions included
- Superior commercial quality die cast metal construction

### APPLICATIONS

- Expands cubic capacity and enables flush finish

### STANDARD MATERIAL

- Copper free aluminum

### STANDARD FINISH

- Premium powder coat finish

PART #	MASTER QTY.	WEIGHT/ CASE (LBS.)	A	B	C
WB2EXT	25	25	4.56"	4.56"	1"

WEATHERPROOF

# PAR LAMP HOLDERS



WPAR50W

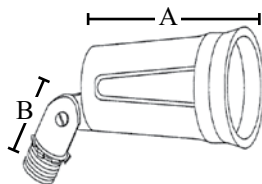

PART #	SIZE	COLOR	MASTER QTY.	WEIGHT/ CASE (LBS.)	A	B
WPAR50	1/2"	GRAY	50	22	2.57"	2"
WPAR50B	1/2"	BRONZE	50	22	2.57"	2"
WPAR50W	1/2"	WHITE	50	22	2.57"	2"

## FEATURES

- Medium base
- 1/2" locknut and gasket included
- 150 Watts
- Max Par38
- Swivels 180°
- Gray, bronze and white

## APPLICATIONS

- UL listed for wet locations

## STANDARD MATERIAL

- Copper free aluminum

## STANDARD FINISH

- Premium powder coat finish

# CLOSURE PLUGS



WP75



WP50PL

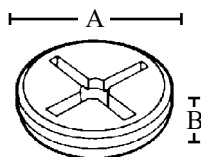

PART #	SIZE	COLOR	MASTER QTY.	WEIGHT/ CASE (LBS.)	A	B
WP50	1/2"	GRAY	100	2	.79"	.33"
WP75	3/4"	GRAY	50	2	1"	.30"
WP100	1"	GRAY	25	2	1.23"	.28"
PLASTIC						
WP50PL	1/2"	GRAY	100	1	.79"	.33"
WP50PLB	1/2"	BRONZE	50	1	.79"	.33"
WP50PLW	1/2"	WHITE	50	1	.79"	.33"
WP75PL	3/4"	GRAY	50	1	1"	.30"

## FEATURES

- 1/2" - 1" closure plugs
- Gray, bronze and white

## APPLICATIONS

- UL listed for wet locations
- Safely seal off unused hubs in metallic outlet boxes

## STANDARD MATERIAL

- Cast aluminum with powder coat finish or plastic

## STANDARD FINISH

- Cast aluminum – premium powder coat finish

# BOX HOLDER



WPB150

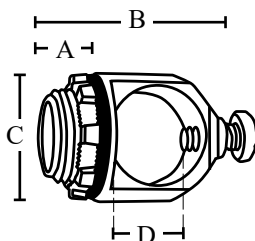

PART #	SIZE	MASTER QTY.	WEIGHT/ CASE (LBS.)	A	B	C	D
WPB150	1/2"	25	40	.38	1.55"	1.125"	.86"

## FEATURES

- Can be used as an external means of support to meet the requirements of 2011 NEC Section 314-23
- Gray

## APPLICATIONS

- Stubs up electrical boxes, and fire alarms with rigid pipe between bar joists
- Installation is easy—simply insert the box support into the electrical box. The entire assembly is held secure with a 1/2" rigid steel conduit or water pipe

## STANDARD MATERIAL

- Corrosion resistant die cast zinc

# RECEPTACLE COVER

## SINGLE



1317

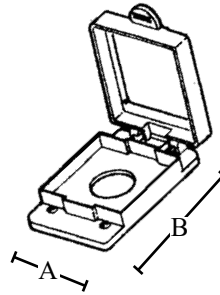

### FEATURES

- Spring loaded lid; weather seal gasket
- Weatherproof cover when closed
- Cover must be matched to the capacity size of the receptacle

### APPLICATIONS

- Fits a single receptacle; prevents damage from water and other elements

### STANDARD MATERIAL

- PVC

PART #	SIZE	HOLE DIAMETER	MASTER QTY.	WEIGHT/ CASE (LBS.)	A	B
1317	15 AMP	1.375	10	3	2.8125"	4.5625"
1318	20 AMP	1.625	10	3	2.8125"	4.5625"
1319	30 AMP	1.722	10	3	2.8125"	4.5625"
1320	50 AMP	2.187	10	3	2.8125"	4.5625"

# GFI RECEPTACLE COVER

## SINGLE



1321

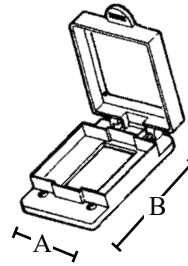

### FEATURES

- Spring loaded lid; weather seal gasket
- Weatherproof cover when closed
- Cover must be matched to the capacity size of the receptacle

### APPLICATIONS

- Fits a single gang FS type box and covers a standard ground fault interrupter receptacle

### STANDARD MATERIAL

- PVC

PART #	MASTER QTY.	WEIGHT/ CASE (LBS.)	A	B
1321	10	3	2.8125"	4.5625"

# DUPLEX RECEPTACLE COVER

## SINGLE



1323

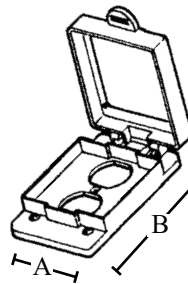

### FEATURES

- Spring loaded lid; weather seal gasket
- Weatherproof cover when closed
- Cover must be matched to the capacity size of the receptacle

### APPLICATIONS

- Fits a single gang FS type box and covers a standard ground fault interrupter receptacle

### STANDARD MATERIAL

- PVC

PART #	MASTER QTY.	WEIGHT/ CASE (LBS.)	A	B
1323	10	3	2.8125"	4.5625"

WEATHERPROOF

# TOGGLE SWITCH COVER

## SINGLE



1316

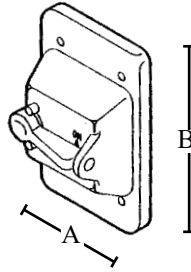

CATALOG NUMBER	MASTER QTY.	WEIGHT/CASE (LBS.)	A	B
1316	10	2	2.8125"	4.5625"

### FEATURES

- Weatherproof cover fits a single gang FS type box

### APPLICATIONS

- Toggle arm operates a standard 115 volt single or double pole switch which is completely enclosed

### STANDARD MATERIAL

- PVC

# PLUNGER SWITCH COVER

## SINGLE



1326

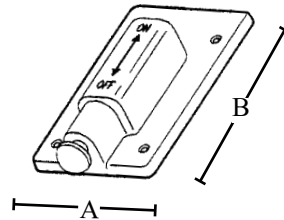

PART #	MASTER QTY.	WEIGHT/CASE (LBS.)	A	B
1326	10	3	2.8125"	4.5625"

### FEATURES

- Weatherproof cover fits a single gang FS type box

### APPLICATIONS

- Plunger operates a standard single or double pole 115 volt switch which is completely enclosed

### STANDARD MATERIAL

- PVC

# SWITCH COVER

## SINGLE



1315

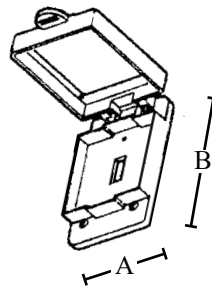

PART #	MASTER QTY.	WEIGHT/CASE (LBS.)	A	B
1315	10	3	2.8125"	4.5625"

### FEATURES

- Weatherproof cover when closed

### APPLICATIONS

- Fits a single gang FS type box and covers a single or double pole standard 115 volt switch

### STANDARD MATERIAL

- PVC

WEATHERPROOF

# BLANK COVER

## SINGLE



1313

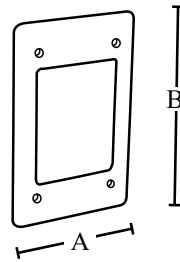

### FEATURES

- Companion to Topaz single PVC boxes
- Rust proof; corrosion resistant

### APPLICATIONS

- For use with a single gang FS type box

### STANDARD MATERIAL

- PVC

PART #	MASTER QTY.	WEIGHT/ CASE (LBS.)	A	B
1313	50	6	2.875"	4.5625"

## DOUBLE



1314

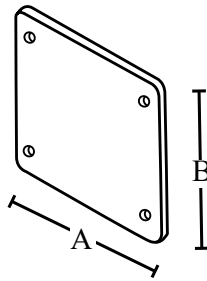

### FEATURES

- Companion to Topaz double PVC boxes
- Rust proof; corrosion resistant

### APPLICATIONS

- For use with a double gang FS type box

### STANDARD MATERIAL

- PVC

PART #	MASTER QTY.	WEIGHT/ CASE (LBS.)	A	B
1314	25	5	4.5625"	4.5625"

WEATHERPROOF



# TWO TOGGLE SWITCH COVER

DOUBLE



1324

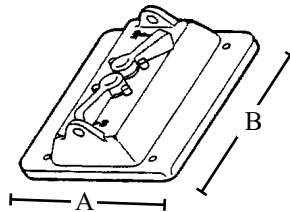

## FEATURES

- Weatherproof when closed
- Easy to access toggle arms operate the enclosed switches

## APPLICATIONS

- Fits double gang FB box that encloses 2 single or double pole 115 volt standard switches

## STANDARD MATERIAL

- PVC

PART #	MASTER QTY.	WEIGHT/ CASE (LBS.)	A	B
1324	10	3	4.5625"	4.5625"

# DUPLEX & TOGGLE SWITCH COVER

DOUBLE



1325

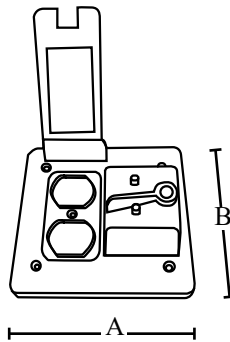

## FEATURES

- Spring loaded lid; weather seal gasket
- Weatherproof cover when closed
- Cover must be matched to the capacity size of the receptacle

## APPLICATIONS

- Fits a double gang FS type box and covers a standard ground fault interrupter receptacle
- Covers 1 single or double pole 115 volt switch & 1 standard 115 volt duplex receptacle

## STANDARD MATERIAL

- PVC

PART #	MASTER QTY.	WEIGHT/ CASE (LBS.)	A	B
1325	10	3	4.5625"	4.5625"

WEATHERPROOF

# FD TYPE BOX

## BLANK - SINGLE

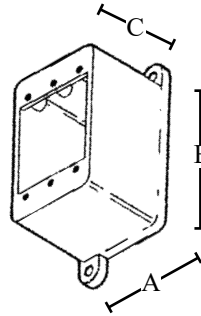

PART #	MASTER QTY.	WEIGHT/CASE (LBS.)	A	B	C
1281	10	4	2.875"	4.5625"	2.375"

### FEATURES

- Mounting feet enable easy installation
- Accommodates standard covers and accessories

### APPLICATIONS

- Commonly used for telecommunications applications
- Use for terminations where hub requirements vary

### STANDARD MATERIAL

- PVC

# FSE TYPE BOXES

## SINGLE

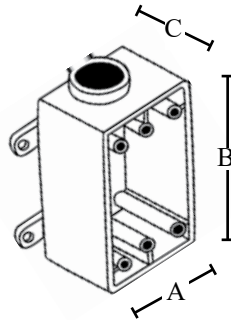

PART #	SIZE	MASTER QTY.	WEIGHT/CASE (LBS.)	A	B	C
1282	1/2"	10	5	2.875"	4.5625"	2.375"
1283	3/4"	10	5	2.875"	4.5625"	2.375"
1284	1"	10	4	2.875"	4.5625"	2.375"

### FEATURES

- Mounting feet enable easy installation
- Accommodates standard covers and accessories
- Surface mounted electrical box which has only one conduit entrance hub with no outlet hub

### APPLICATIONS

- Use for dead end terminations

### STANDARD MATERIAL

- PVC

# FSC TYPE BOXES

## SINGLE

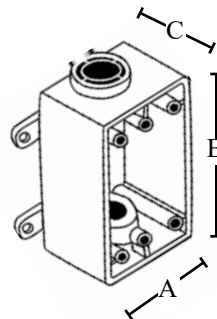

PART #	SIZE	MASTER QTY.	WEIGHT/CASE (LBS.)	A	B	C
1288	1/2"	10	5	2.875"	4.5625"	2.375"
1289	3/4"	10	5	2.875"	4.5625"	2.375"
1290	1"	10	5	2.875"	4.5625"	2.375"

### FEATURES

- Mounting feet enable easy installation
- Accommodates standard covers and accessories
- Surface mounted electrical box which has one conduit entrance hub in each of the two short walls of the box

### APPLICATIONS

- Use for straight line conduit runs, splices and through terminations
- Uses single gang electrical device cover

### STANDARD MATERIAL

- PVC

# FSS TYPE BOXES

## SINGLE



1294

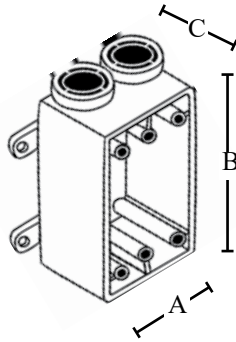

PART #	MASTER QTY.	WEIGHT/ CASE (LBS.)	A	B	C
1294	10	5	2.875"	4.5625"	2.375"
1295	10	5	2.875"	4.5625"	2.375"
1296	10	4	2.875"	4.5625"	2.375"

### FEATURES

- Mounting feet enable easy installation
- Accommodates standard covers and accessories
- Surface mounted electrical box which has two conduit entrance hubs on one short wall of the box only

### APPLICATIONS

- Use for straight line conduit runs, splices and for multiple dead end circuit terminations
- Ideal when additional support is required for stub ups
- Uses single gang electrical device cover

### STANDARD MATERIAL

- PVC

# FSCC TYPE BOXES

## SINGLE



1301

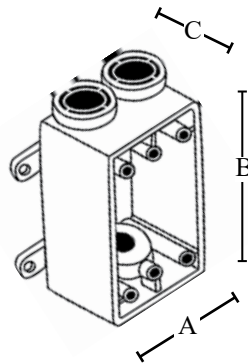

PART #	MASTER QTY.	WEIGHT/ CASE (LBS.)	A	B	C
1301	10	5	2.875"	4.5625"	2.375"
1302	10	5	2.875"	4.5625"	2.375"
1303	10	4	2.875"	4.5625"	2.375"

### FEATURES

- Mounting feet enable easy installation
- Accommodates standard covers and accessories
- Surface mounted electrical box that has two conduit entrance hubs in one wall of the box and one hub in the opposite wall

### APPLICATIONS

- Use for straight line conduit runs, splices and multiple through terminations
- Ideal when additional support is required for stub ups
- Uses single gang electrical device cover

### STANDARD MATERIAL

- PVC

WEATHERPROOF

# FDC TYPE BOXES

## SINGLE



1307

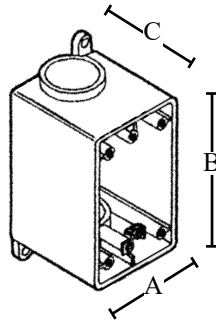

PART #	SIZE	MASTER QTY.	WEIGHT/CASE (LBS.)	A	B	C
1307	1/2"	10	6	2.875"	4.5625"	3"
1308	3/4"	10	6	2.875"	4.5625"	3"
1309	1"	10	5	2.875"	4.5625"	3"

### FEATURES

- Surface mounted electrical box with grounding lug has one conduit entrance hub in each of the two short walls of the box

### APPLICATIONS

- Use for straight line conduit runs and splices
- Uses single gang electrical device cover

### STANDARD MATERIAL

- PVC

# FDS TYPE BOXES

## SINGLE



1310

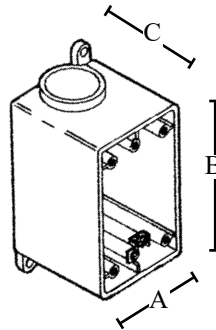

PART #	SIZE	MASTER QTY.	WEIGHT/CASE (LBS.)	A	B	C
1310	1/2"	10	4	2.875"	4.5625"	3"
1311	3/4"	10	6	2.875"	4.5625"	3"
1312	1"	10	5	2.875"	4.5625"	3"

### FEATURES

- Surface mounted electrical box with grounding lug has one conduit hub on short wall side

### APPLICATIONS

- Use for straight line conduit runs and splices
- Uses single gang electrical device cover

### STANDARD MATERIAL

- PVC

WEATHERPROOF

# FSE TYPE BOXES

## DOUBLE



1285

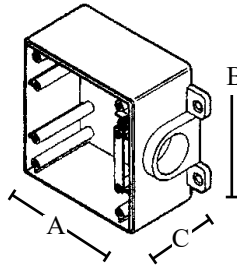

PART #	MASTER QTY.	WEIGHT/ CASE (LBS.)	A	B	C
1285	5	3	4.5625"	4.5625"	2.375"
1286	5	3	4.5625"	4.5625"	2.375"
1287	5	3	4.5625"	4.5625"	2.375"

### FEATURES

- Mounting feet enable easy installation
- Accommodates standard covers and accessories
- Surface mounted electrical box which has only one conduit entrance hub with no outlet hub

### APPLICATIONS

- Use for dead end terminations
- Uses double gang device covers

### STANDARD MATERIAL

- PVC

# FSC TYPE BOXES

## DOUBLE



1291

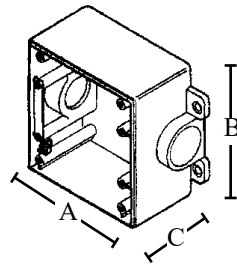

PART #	MASTER QTY.	WEIGHT/ CASE (LBS.)	A	B	C
1291	5	4	4.5625"	4.5625"	2.375"
1292	5	4	4.5625"	4.5625"	2.375"
1293	5	3	4.5625"	4.5625"	2.375"

### FEATURES

- Mounting feet enable easy installation
- Accommodates standard covers and accessories
- Surface mounted electrical box which has one conduit entrance hub in each of the two opposite walls of the box

### APPLICATIONS

- Use for straight line conduit runs, splices and through terminations
- Uses double gang electrical device cover

### STANDARD MATERIAL

- PVC

WEATHERPROOF

# FSS TYPE BOXES

## DOUBLE



1297

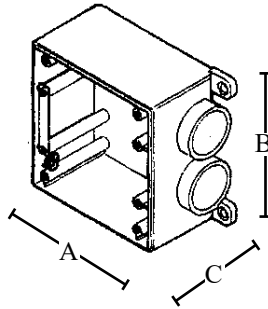

PART #	SIZE	MASTER QTY.	WEIGHT/ CASE (LBS.)	A	B	C
1297	1/2"	5	4	4.5625"	4.5625"	2.375"
1298	3/4"	5	3	4.5625"	4.5625"	2.375"
1299	1"	5	3	4.5625"	4.5625"	2.375"

### FEATURES

- Detachable mounting feet enable easy installation
- Accommodates standard covers and accessories
- Surface mounted electrical box which has two conduit entrance hubs on one wall of the box only

### APPLICATIONS

- Use for straight line conduit runs, splices and for multiple dead end circuit terminations
- Ideal when additional support is required for stub ups
- Uses double gang electrical device cover

### STANDARD MATERIAL

- PVC

# FSCC TYPE BOXES

## DOUBLE



1304

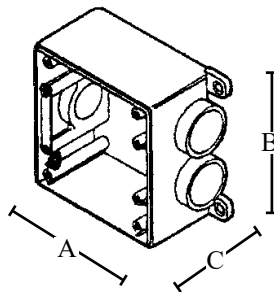

PART #	SIZE	MASTER QTY.	WEIGHT/ CASE (LBS.)	A	B	C
1304	1/2"	5	4	4.5625"	4.5625"	2.375"
1305	3/4"	5	4	4.5625"	4.5625"	2.375"
1306	1"	5	3	4.5625"	4.5625"	2.375"

### FEATURES

- Mounting feet enable easy installation
- Accommodates standard covers and accessories
- Surface mounted electrical box that has two conduit entrance hubs in one wall of the box and one hub in the opposite wall

### APPLICATIONS

- Use for straight line conduit runs, splices and multiple through terminations
- Ideal when additional support is required for stub ups
- Uses double gang electrical device cover

### STANDARD MATERIAL

- PVC

WEATHERPROOF

# VAPORPROOF FIXTURES



## FEATURES

- Ceiling, wall or pendant mounting
- All assembled fixtures are equipped with 5 holes and available with 1/2" & 3/4" threaded holes
- Socket with leads
- Heat resistant glass globe
- Prevents moisture entry
- Industrial grade, fully gasketed
- Designed to protect the interior from deteriorating effect of ice, corrosive fumes, and non-explosive vapors
- Gray

## APPLICATIONS

- UL listed for wet locations
- Maintains illumination for safety and performance in inclement weather
- Input Voltage: 120V

## STANDARD MATERIAL

- Rugged die cast copper free aluminum

## STANDARD FINISH

- Premium powder coat finish

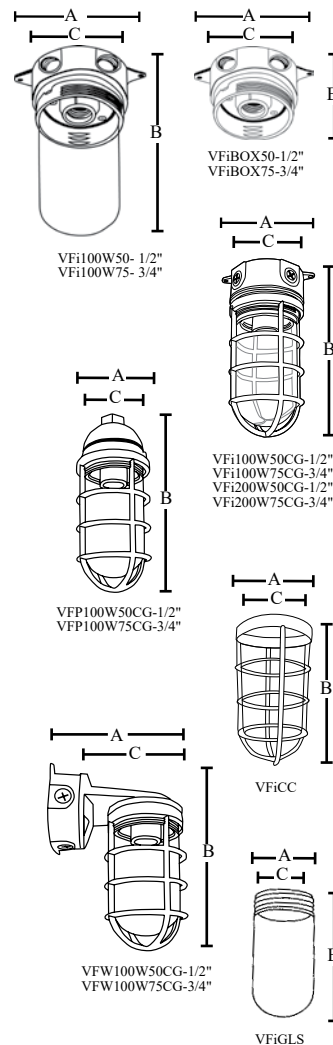

PART #	# OF HOLES	THREAD SIZE	SHIP CASE	WEIGHT/ CASE (LBS.)	A	B	C
VF100W50*	5	1/2"	6	13	5.25"	8.50"	3.25"
VF100W75*	5	3/4"	6	13	5.25"	8.50"	3.25"
VF100W50CG*	5	1/2"	6	16	5.25"	9"	4.13"
VF100W75CG*	5	3/4"	6	16	5.25"	9"	4.13"
VF200W50CG**	5	1/2"	6	16	5.25"	11.50"	5.15"
VF200W75CG**	5	3/4"	6	16	5.25"	11.50"	5.15"
VFIBOX50	5	1/2"	12	13	5.25"	3.50"	4.13"
VFIBOX75	5	3/4"	12	13	5.25"	3.50"	4.13"
VFP100W50CG*	-	1/2"	6	16	4.13"	10.25"	3.88"
VFP100W75CG*	-	3/4"	6	16	4.13"	10.25"	3.88"
VFW100W50CG*	5	1/2"	6	19	7.25"	10"	4.13"
VFW100W75CG*	5	3/4"	6	19	7.25"	10"	4.13"
<b>VAPORPROOF 7" GLASS GLOBE</b>							
VFGLS			6	6	3.25"	7"	3"
<b>7" CAST CAGE</b>							
VFIC			16	11	4.25"	7.25"	4.13"

### UL Listing:

Suitable for wet locations for use in dwellings. Suitable for use with 90° C supply wiring. Complies with UL Standard 1598. For non-hazardous locations where the lamp, socket and wiring require protection from rain, corrosive fumes, non-explosive vapors and gases.

\*Approved for maximum 100W incandescent. \*\*Approved for maximum 200W incandescent.

**WEATHERPROOF**



**Southwire™**

# **WEATHERPROOF**

## **CATALOG**

### **GET SOCIAL WITH US:**



**/SOUTHWIRETOOLS**  
**/SOUTHWIRETOOLSLATINO**



**@SOUTHWIRETOOLS**



**@SOUTHWIRETOOLS**



**SOUTHWIRETOOLS**

**SOUTHWIRE.COM | 1-855-SWTOOLS**

All Trademarks or Registered Trademarks (TM/®) are owned or licensed by Southwire Company.  
Any other TM/® - Trademark or Registered Trademark of Southwire Company.