

POWER CABLE MANUAL

4TH EDITION

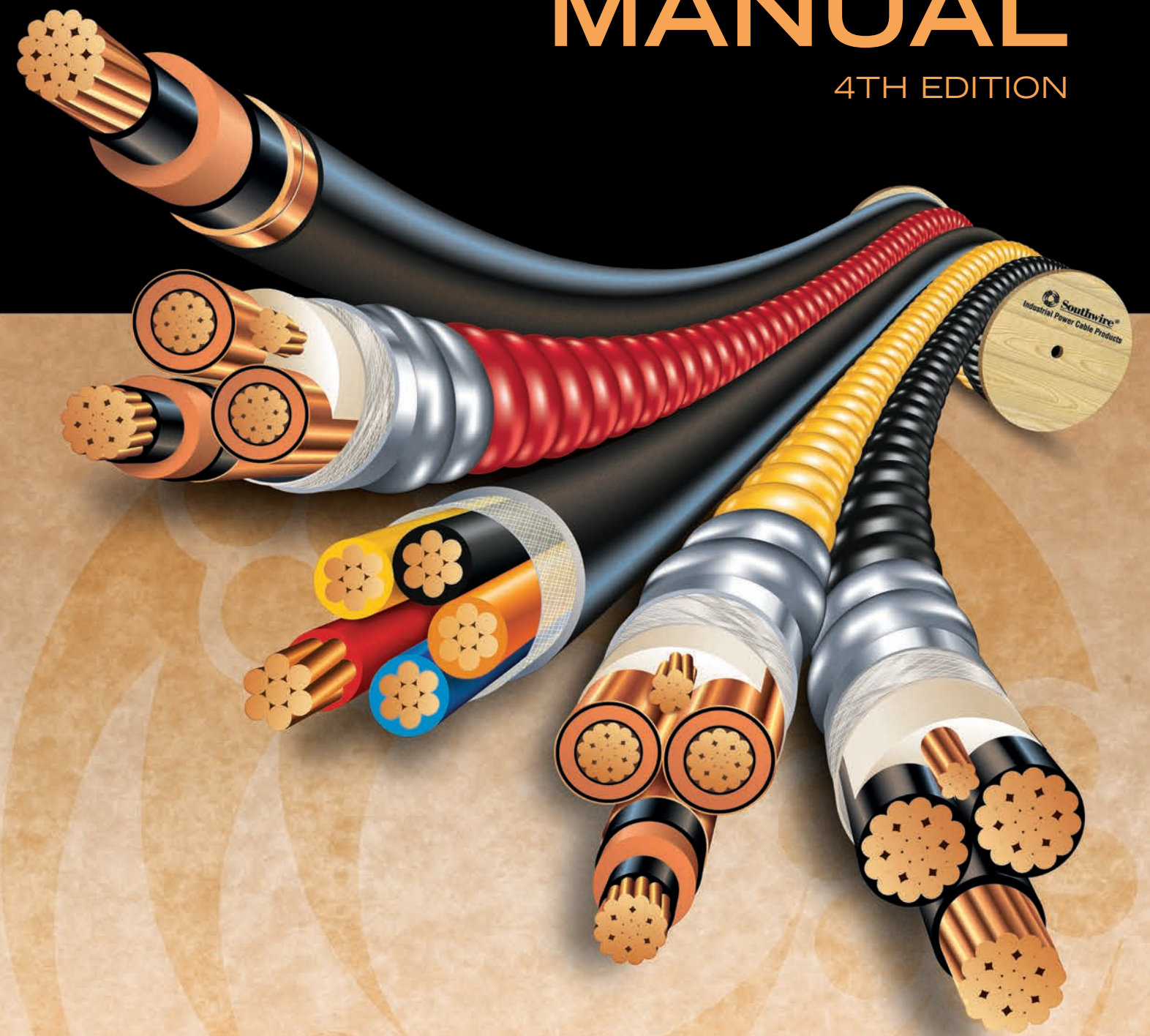

POWER CABLE MANUAL

4TH EDITION



Southwire Company
One Southwire Drive
Carrollton, Georgia 30119, USA
800.444.1700

WWW.SOUTHWIRE.COM

7500/1216

© 2016 Southwire Company



POWER CABLE MANUAL

4TH EDITION

Edited by

Thomas P. Arnold

Manager of Power Cable Technology

C. David Mercier

Applications Engineering Manager

David Cooper

Brian Sides

Robert J. Fazio

John Armstrong

Paul White

Southwire Company
One Southwire Drive
Carrollton, Georgia 30119, USA
800.444.1700

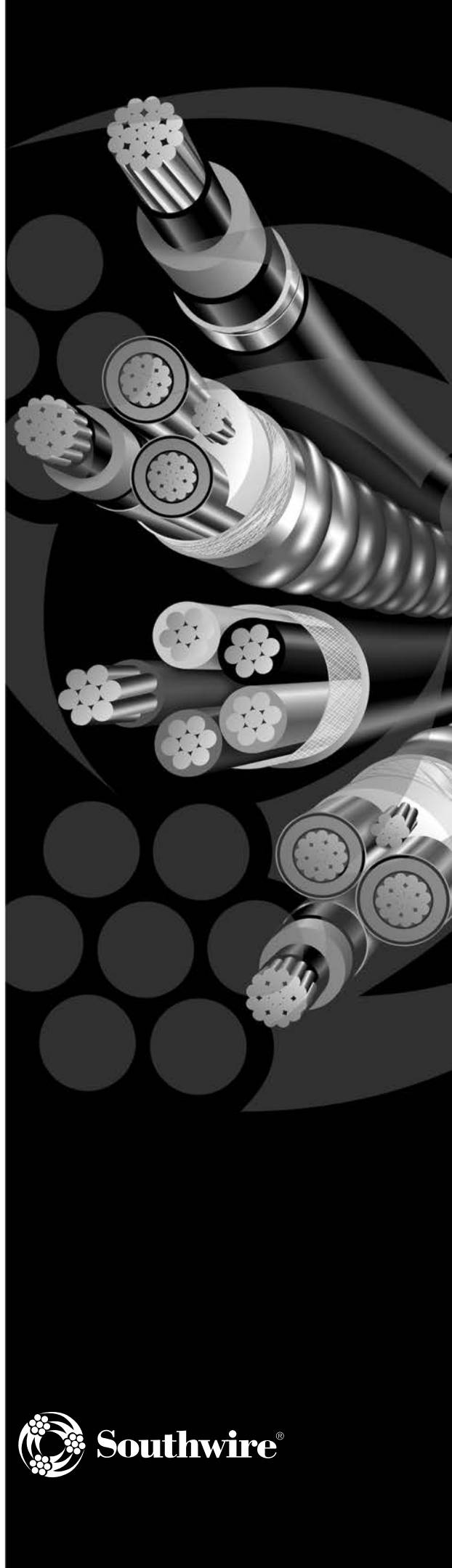

Southwire Company
One Southwire Drive
Carrollton, Georgia 30119

© 2005 Southwire Company. All rights reserved.
Printed in the United States of America.

Hypalon is a registered trademark of E.I. DuPont DeNemours & Company.
National Electrical Code and NEC are registered trademarks of the
National Fire Protection Association.

Materials on pages 2-12 and 7-32 and the tables of electrical characteristics of cable systems on pages 6-31 through 6-49 are reprinted with permission from NFPA 70-2005, the National Electric Code, © 2005 National Fire Protection Association, Quincy, Massachusetts 02269. This reprinted material is not the complete and official position of the National Fire Protection Association on the referenced subject, which is represented only by the standard in its entirety.

This publication is a collection of items of general information related to the subject of power cable. It is not intended to be nor should it be used as authority for design, construction, or use of power cable. The design, construction, and use of power cable should only be undertaken by competent professionals in light of currently accepted design and engineering practices.

While great care has been employed to ensure that the tables and formulas contained herein are free of errors, absolutely no warranties, either expressed or implied, are made as to the accuracy or completeness of any such tables and formulas contained herein.

Those preparing and/or contributing to this publication specifically disclaim any warranty of any kind, either expressed or implied. The warranties of merchantability and fitness for a particular purpose are hereby specifically disclaimed by Southwire and all other parties involved in the creation, production, or delivery of this publication.

Neither Southwire nor anyone else who has been involved in the creation, production, or delivery of this publication shall be liable for any direct, indirect, consequential, or incidental damages arising out of the use, the results of the use, or inability to use such publication, even if Southwire has been advised of the possibility of such damages or claim. Some states do not allow the exclusion or limitation for consequential incidental damages, so the above limitation may not apply to you.

FOREWORD

Welcome to the third edition of the Southwire Company Power Cable Manual. Since we first published this manual in 1991, we had distributed more than 20,000 copies within the wire and cable industry. Your response to the first and second editions was very encouraging. We greatly appreciate all of your positive reviews and helpful suggestions. We are pleased to be able to make available a third edition providing valuable information in addressing your technical questions.

Our objective at Southwire is to be your primary source for wire and cable products and technical information. In addition to this manual, you may find valuable resources to aid in answering your technical questions at www.southwire.com. Included is extensive information on Southwire products and services, detailed technical information, copies of our industry technical papers, product catalog, and monthly newsletters: Power Cable Update and T&D Update.

USING THIS MANUAL

The Southwire Power Cable Manual provides engineering and installation information for extruded dielectric power cable systems. The manual covers copper and aluminum conductors from No. 14 AWG through 1000 kcmil, insulated for operation from 600 volts through 35 kilovolts. Although this manual includes specific recommendations in certain sections, it is impossible to cover all possible design, installation, and operating situations for every application. Please use the information in this manual as general guidelines only.

We kept the contents as concise as possible while providing the basics of power cable system engineering and installation. This manual is intended for users who have an understanding of the engineering fundamentals of power cable systems. For additional details and assistance, consult the reference publications listed at the end of the manual or contact Southwire.

This manual includes many tables, equations, and related data for the convenience of the user. Southwire's Product Catalog, available at www.southwire.com, provides additional data on cable weights, dimensions, and specifications to be used in concert with this manual.

This manual is not a complete representation of the full range of wire and cable products offered by Southwire. For information on any of your wire and cable needs, please contact your local Southwire representative.

We welcome your suggestions on the third edition so that we can make future editions more relevant, more current, and easier to use. We are constantly expanding our technical resources and encourage you to send the enclosed response card or comments via e-mail to talktous@southwire.com. Updates to the manual can be found in the Technical Libraries section of Southwire's web site at www.southwire.com.

REFERENCE ORGANIZATIONS

Below is a listing of organizations whose codes, standards, and technical papers are referenced in this manual.

Association of Edison Illuminating Companies (AEIC)
600 North 18th Street
Birmingham, AL 35291-0992
www.aeic.org

The Aluminum Association
900 19th Street, N.W.
Washington, DC 20006
www.aluminum.org

American National Standards Institute (ANSI)
25 West 43rd Street, 4th floor
New York, NY 10036
www.ansi.org

American Society for Testing and Materials (ASTM)
100 Barr Harbor Drive
West Conshohocken, PA 19428-2959
Philadelphia, PA 19103
www.astm.org

Canadian Standards Association (CSA)
5060 Spectrum Way
Mississauga, Ontario, Canada L4W 5N6
www.csa.ca

Electric Power Research Institute (EPRI)
3412 Hillview Avenue
Palo Alto, CA 94303
www.epri.com

Insulated Cable Engineers Association (ICEA)
P.O. Box 1568
Carrollton, GA 30112
www.icea.org

Institute of Electrical and Electronics Engineers (IEEE)
3 Park Avenue, 17th Floor
New York, NY 10016-5997
(National Electric Safety Code)
www.ieee.org

National Electrical Manufacturers Association (NEMA)
1300 North 17th Street, Suite 1847
Rosslyn, VA 22209
www.nema.org

National Fire Protection Association (NFPA)
Batterymarch Park
Quincy, MA 02669
(National Electrical Code)
www.nfpa.org

Underwriters Laboratories, Inc. (UL)
333 Pfingsten Road
Northbrook, IL 60062
www.ul.com

TABLE OF CONTENTS

1. BASICS OF INSULATED POWER CABLE CONSTRUCTION 1-1

NONSHIELDED CABLE	1-1
Construction	1-1
Dielectric Field	1-2
SHIELDED CABLE	1-3
Construction	1-3
Dielectric Field	1-4
ADVANTAGES OF SHIELDED CABLE	1-5

2. CONDUCTORS 2-1

SIZE AND AREA RELATIONSHIPS	2-1
CONDUCTOR CHARACTERISTICS	2-3
Copper and Aluminum Properties	2-3
Conductor Diameters	2-4
Conductor Weights	2-6
Breaking Strengths	2-10
COPPER	2-11
Tempers	2-12
ALUMINUM	2-12
Alloys	2-12
Tempers	2-12
STRAND BLOCK	2-13
RESISTANCE TABULATIONS	2-13
Resistivity and Conductivity	2-13
DC Resistance Versus Cross-Sectional Area	2-14
Resistance at Other Temperatures	2-16
AC to DC Ratios	2-17

3. INSULATIONS 3-1

TYPES	3-1
Polyethylene	3-1
Cross-linked Polyethylene	3-1
Ethylene-Propylene Rubber	3-2
Polyvinyl Chloride	3-3
Chlorosulfonated Polyethylene	3-3
Non-Halogen Ethylene Copolymers	3-3

INSULATION PROPERTIES	3-4
WALL THICKNESSES	3-5
ICEA Insulated Cables	3-5
NEC/UL-Listed Cables	3-5

4. SHIELDING OR SCREENING 4-1

CONDUCTOR SHIELD	4-1
INSULATION SHIELD	4-1
Materials	4-1
Voltage Parameters	4-2
Requirements for Use	4-2
GROUNDING OF INSULATION SHIELD	4-2
Single-Point Grounding	4-3
Multiple-Point Grounding	4-3

5. JACKETING, SHEATHING, AND ARMORING 5-1

GENERAL	5-1
NONMETALLIC JACKETS	5-1
METALLIC SHEATHS	5-2
Lead Sheathing	5-2
Aluminum Sheathing	5-3
ARMORING	5-3
Gas/Vaportight Continuously Corrugated	5-3
Interlocked	5-3
Flat Metal Tapes	5-4
Round Wire	5-4
SPECIAL JACKET OR SHEATH COMBINATIONS	5-4
Teck Cable	5-4

6. ELECTRICAL CHARACTERISTICS OF CABLE SYSTEMS 6-1

BASIC POWER SYSTEM REVIEW	6-1
DC Circuits	6-1
Single-Phase AC Circuits	6-1
Polyphase AC Circuits	6-2
VOLTAGE RATING	6-3
General System Categories	6-3
Voltage Potentials	6-4
FORMULAS AND RELATED INFORMATION	6-4
Inductance	6-4
Inductive Reactance	6-5
Dielectric Constant	6-6

Capacitance	6-6
Capacitive Reactance	6-6
Charging Current	6-7
Total Reactance	6-7
Impedance	6-7
Insulation Resistance and IR Constant	6-7
Power Factor	6-8
Cable System Impedance at Power Frequencies	6-9
Ampere Determination From Power Ratings	6-10
Breakdown Strength	6-10
Voltage Stress	6-10
VOLTAGE DROP (REGULATION)	6-11
Equations for Basic AC and DC Power Systems	6-12
Typical Calculation	6-13
SHORT CIRCUIT CURRENTS	6-14
Conductor Formula	6-14
Metallic Shield Formula	6-21
Typical Calculation	6-22
SHIELD VOLTAGES, CURRENTS, AND LOSSES FOR SINGLE CONDUCTOR CABLES	6-23
Multiple-Point Grounded Shields	6-23
Single-Point Grounded Shields	6-24
Reduced Concentric Neutral Shield Wires	6-25
AMPACITY	6-26
Formula	6-26
Ampacity Tables	6-30
SEQUENCE IMPEDANCE	6-50
Symmetrical Components	6-50
Effect of Variables	6-51
SEQUENCE IMPEDANCE EQUATIONS	6-54
Tape Shielded Medium Voltage Cables	6-54
Wire Shielded and Concentric Neutral Medium Voltage Cable	6-55
Variables for Sequence Impedance Equations	6-58
Typical Calculation	6-62

7. CABLE INSTALLATION

GENERAL FIELD PRACTICES	7-1
Introduction	7-1
Preplanning	7-1
Low Ambient Temperature	7-2
Equipment	7-2
Training Radius	7-4
Handling and Storage Guidelines	7-5

Dynamometer Corrections	7-7
Diameters of Nonjacketed Cable Assemblies	7-8
Pull Boxes	7-8
Cable Lubrication Selection	7-9
INSTALLATION IN CONDUIT	7-10
Allowable Tension on Pulling Device	7-10
Maximum Tension on Cable Conductors	7-10
Equations for Pulling Tension	7-13
Coefficient of Friction	7-14
Configuration	7-15
Weight Correction Factor	7-15
Sidewall Pressure	7-16
Clearance	7-17
Jamming	7-17
Conduit Fill	7-18
Calculation Procedure	7-19
INSTALLATION IN CABLE TRAY	7-20
Rollers and Sheaves	7-20
Pulling Tensions	7-21
TYPICAL CALCULATION FOR CABLES IN CONDUIT	7-23
CABLES BURIED DIRECTLY IN EARTH	7-28
Depth of Burial	7-28
Trenching	7-28
Plowing	7-29
Supplemental Information	7-29
AERIAL INSTALLATION	7-29
Sag and Tension	7-29
Ice and Wind Loading	7-30
Additional Information	7-31
CABLES UNDER VERTICAL TENSION	7-31
ICEA Support Requirements	7-31
NEC Support Requirements	7-32
FIELD REMOVAL OF MOISTURE FROM POWER CABLES	7-33
Required Materials	7-33
General Purging Process	7-33
Purging Cable Conductors	7-34
Purging Cable Shield	7-35
Cable on Reels	7-35

8. DESIGN AND INSTALLATION OF CABLE ACCESSORIES 8-1

GENERAL	8-1
CABLE ACCESSORIES	8-1
Design Concepts	8-1

Basis of Electrical Design	8-2
Design Testing	8-3
Terminations of Nonshielded Cables	8-3
Terminations of Shielded Cables	8-3
Splices of Nonshielded Cables	8-6
Splices of Shielded Cables	8-6
FIELD INSTALLATION	8-9
Cable Component Identification	8-9
Cleanliness	8-10
Cable End Preparation	8-10
Conductor Connections	8-11
Dielectric System Materials	8-12
CABLE END PREPARATION TOOLS	8-13
HARDWARE FOR INTERLOCKED ARMOR CABLES	8-14
CABLE ACCESSORIES MANUFACTURERS	8-14

9. FIELD TESTING 9-1

SAFETY	9-1
PREPARATION FOR TESTING	9-1
CONDUCTING TEST	9-2
CONCLUSION OF TESTING	9-2
FIELD ACCEPTANCE TESTS	9-2
Cable System Integrity	9-2
Low Potential Testing of Dielectric	9-3
High Potential DC Testing of Dielectric	9-4

APPENDIX A-1

CAPACITY AND DRUM DIAMETER OF REELS	A-1
Reel Capacity Equation	A-1
Approximate Reel Capacity Equation	A-2
Minimum Drum Diameter	A-2
TABULATIONS OF EQUIVALENTS	A-3
Nominal Conductor Area	A-3
Conversion Factors	A-4
Temperature Equivalents	A-5
Metric Unit Multiples	A-5
SYMBOLS	A-6
Greek Alphabet	A-6
Typical Symbol Usage	A-7
REFERENCE PUBLICATIONS	A-8
INDEX	A-11

BASICS OF INSULATED POWER CABLE CONSTRUCTION

An insulated power cable appears to be a relatively simple electrical device. In fact, this cable is an electrically sophisticated system of components. To understand it, let us examine its components and basics of operation. For simplicity, the following discussion will be confined to single-conductor cables. However, these fundamentals also apply to multiple-conductor cables.

NONSHIELDED CABLE

Construction

Two basic components comprise a nonshielded cable: the conductor and the electrical insulation sometimes referred to as the dielectric. A third component used in some cable designs is an outer jacket. (See Figure 1-1.)

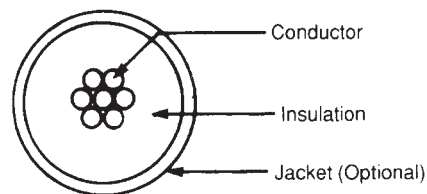

Figure 1-1
Construction of Low Voltage Nonshielded Cable

Conductor

The conductor can be copper or aluminum with either a solid or stranded cross section. The primary benefit of stranded conductors is improved flexibility. Stranded conductors can also be compressed, compacted, or segmented to achieve desired flexibility, diameter, and load current density. For the same cross-sectional area of a conductor, the diameter differs among solid and the various types of stranded conductors. This consideration is important in the selection of connectors and in methods of splicing and terminating.

Chapter 2 presents details of conductors and their characteristics.

Electrical Insulation or Dielectric

The electrical insulation must provide adequate physical protection and electrical insulation between the energized conductor and the nearest electrical ground to prevent electrical breakdown. For low-voltage cables, 600 volts and below, the insulation thickness required to provide the necessary physical protection against damage is more than adequate to provide the necessary dielectric strength.

Jacket

For special applications, a jacket is applied over the insulation. Several materials are available for use as jackets to provide the necessary chemical, physical, or thermal protection required by the application.

Dielectric Field

Another consideration in the design and application of cables is the dielectric field. In all electrical cables, irrespective of their voltage ratings, a dielectric field is present when the conductor is energized. This dielectric field is typically represented by **electrostatic flux lines** and **equipotential lines** between the conductor and electrical ground.

When a conductor is energized, electrostatic lines of flux are created within the dielectric. The density of these flux lines is dependent upon the magnitude of the potential difference between the conductor and electrical ground.

The distance between the equipotential lines represents a voltage differential in the insulation. For a given voltage differential, these lines are closer together nearer the conductor.

Figure 1-2 represents the electrical field of a nonshielded cable in contact with a ground plane. It does not take into account the difference in the dielectric constants of the insulation and the surrounding air.

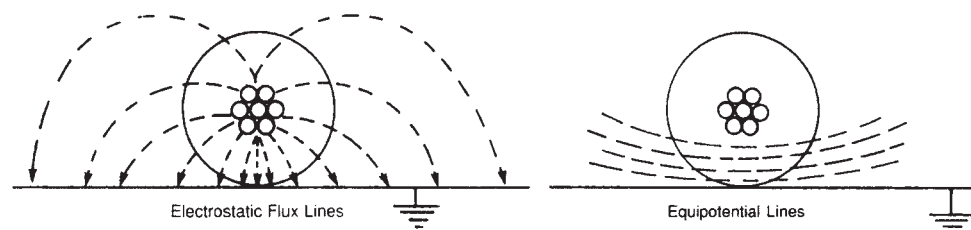

Figure 1-2
Dielectric Field of Low-Voltage Nonshielded Cable
In Contact with Electrical Ground

Observe that the electrostatic flux lines are crowded in the insulation area closest to the ground. Also, the equipotential lines are eccentric in their relationship to the conductor and cable dielectric surface. This distortion of the fields is acceptable if the dielectric strength of the cable insulation is adequate to resist the concentration of the dielectric stresses. Low-voltage nonshielded cables are designed to meet this requirement.

SHIELDED CABLE

Construction

A fundamental difference between nonshielded and shielded cable is the inclusion of conducting components in the cable system. The basic components of a shielded cable are shown in Figure 1-3.

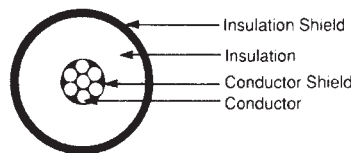

Figure 1-3
Construction of Shielded Power Cable

Conductor

The conductors used in shielded cables are comparable to those used in nonshielded cables.

Conductor Shield or Screen

The conductor shield is usually a semiconducting material applied over the conductor circumference to smooth out the conductor contours. Because of the presence of the shield, the resulting dielectric field lines will not be distorted by the shape of the outer strands or other conductor contours. This layer also provides a smooth and compatible surface for the application of the insulation, and may also be used to facilitate splicing and terminating the cable.

Chapter 4 presents detailed requirements and materials for the conductor shield.

Electrical Insulation or Dielectric

The differences between insulation for shielded and nonshielded cables include material, process technology, and testing. The insulation thickness is primarily influenced by the operating voltage.

Chapter 3 provides information on insulating materials and their capabilities, properties, and applicable specifications.

Insulated Shield or Screen

The insulation shield or screen is a two-part system composed of an auxiliary and a primary shield.

An **auxiliary shield** is usually a semiconducting nonmetallic material over the dielectric circumference. It must be smooth, compatible with the insulation, and exhibit an acceptably low voltage drop through its thickness. A commonly used auxiliary shield consists of an extruded semiconducting layer partially bonded to the insulation.

A **primary shield** is a metallic shield (wire or tape) over the circumference of the auxiliary shield. It must be capable of conducting the summation of “leakage” currents to the nearest ground with an acceptable voltage drop. In some cases it must also be capable of conducting fault currents.

The primary shield by itself, without an intervening auxiliary shield, cannot achieve acceptable physical contact with the dielectric surface. A relatively resilient auxiliary shield is necessary to eliminate arcing between the dielectric surface and the primary shield. Chapter 4 presents detailed requirements and materials for the primary shield.

Jackets/Sheaths/Armors

The cable may have components to provide environmental protection over the insulation shielding system. This material can be an extruded jacket of synthetic material, metal sheath/wires, armoring, or a combination of these types of materials. Chapter 5 presents a description of the types of materials, their characteristics, and applications used for this purpose.

Dielectric Field

The insulation shield should be effectively at ground potential, resulting in no distortion of the electrostatic flux or equipotential lines. Electrostatic flux lines are spaced symmetrically and perpendicular to equipotential lines. The equipotential lines are concentric and parallel with respect to each other, the conductor shield, and the insulation shield. The presence of the shielding results in field lines as depicted in Figure 1-4.

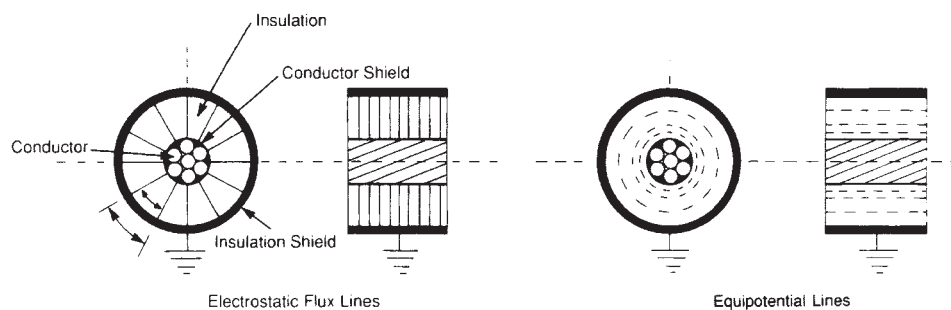

Figure 1-4
Dielectric Field of Shielded Power Cable

In a shielded cable, all the voltage difference between the conductor and electrical ground is contained within the cable. For nonshielded cable, the voltage difference between conductor and electrical ground is divided between the cable dielectric and any intervening air or other materials.

In Figure 1-4, the field lines are closer to each other near the conductor shield as compared to the insulation shield. The radial stresses or voltage gradients increase near the conductor.

ADVANTAGES OF SHIELDED CABLE

Electrical insulation surrounding a conductor creates a capacitor when the conductor is electrically energized. Thus, all insulated conductors are capacitors.

In the majority of nonshielded cable systems, the cable surface makes intermittent contact with an electrical ground. Where intimate contact with this ground is not made, the intervening air spaces also act primarily as capacitors in ac circuits and as resistors in dc circuits. This forms a series circuit of cable dielectric and air dielectric. The voltage across this series circuit varies along the length of the cable dependent upon the voltage across the air gap. The cable surface becomes a floating voltage point in a voltage divider. This floating-point voltage can vary considerably, dependent upon the cable design and the characteristics of the air gap. If the voltage is high enough, the cable surface can experience detrimental surface tracking or arcing discharges to electrical ground. The cable surface can also become potentially hazardous, causing an electrical shock if contacted by field personnel.

Shielding the cable dielectric surface and grounding this shielding eliminates tracking and arcing discharges. Grounding the shield prevents the accumulation of an electrical potential on the surface of the cable that could be hazardous to individuals coming into contact with the cable surface. Industry standards and requirements define when shielded cables must or should be used. This subject is discussed in more detail in Chapter 4.

Service performance of nonshielded cables systems, within their design limits, is generally considered acceptable. In addition to operating voltage limitations, inherent physical size limitations would be encountered if attempting to design and construct nonshielded cable systems for voltages that typically use shielded cable systems.

CONDUCTORS

Conductor selection is contingent upon a number of considerations, including requirements of ampacity, voltage regulation, materials characteristics, flexibility, geometric shape, and economics. The most commonly used metals for conductors in power cables are copper and aluminum. These conductor materials may be solid or stranded.

SIZE AND AREA RELATIONSHIPS

A conductor's size is usually specified based on the conductor's cross-sectional area. Standard practice in the United States is to identify conductor size by the American Wire Gage (AWG) and by thousand circular mils (kcmil) for conductor sizes larger than 4/0 AWG. International practice is usually square millimeters (mm²). For standard conductors, the area is based on the sum of the area of individual strands.

The American Wire Gage, also known as the Brown & Sharpe gage, was developed in 1857 by J.R. Brown. The gage is formed by the specification of two diameters with a specific number of intermediate diameters formed by a geometric progression. The largest AWG size is a 0000 (4/0) gage defined as 0.4600 inches in diameter. The smallest diameter is 0.0050 inches for a 36 gage. Between these two diameters are 38 AWG sizes. Thus, the ratio of any diameter to the next greater diameter is given by the expression:

$$\left[\frac{0.4600}{0.0050} \right]^{\frac{1}{39}} = \sqrt[39]{92} = 1.122932$$

Standard practice in the United States for wire sizes larger than 4/0 AWG is to designate the size by the cross-sectional area in kcmil (formerly, MCM). One cmil is defined as the area of a circle having a diameter of one mil. To determine the cmil area of a solid conductor, square the diameter in mils.

$$1 \text{ mil} = 0.001 \text{ inches}$$

Example:

$$8 \text{ AWG solid diameter} = 0.1285 \text{ inches} = 128.5 \text{ mils}$$

$$\text{cmil} = (128.5)^2 = 16,512$$

Conductor size conversions can be accomplished by the following relationships.

$$\begin{aligned} \text{cmils} &= \text{area in inch}^2 \cdot \frac{4}{\pi} \cdot 10^6 \\ &= \text{area in inch}^2 \cdot 1,273,240 \end{aligned}$$

$$\begin{aligned} \text{cmils} &= \left[\frac{\text{area in mm}^2 \cdot \frac{4}{\pi} \cdot 10^6}{(25.4)^2} \right] \\ &= \text{area in mm}^2 \cdot 1,973.5 \end{aligned}$$

where: 25.4mm = 1 inch

Stranded conductors provide desired properties of flexibility but with some increase in overall diameter. Diameters of stranded conductors vary depending upon constructions. These constructions include concentric round, compressed, compact, and compact sector as shown in Figure 2-1.

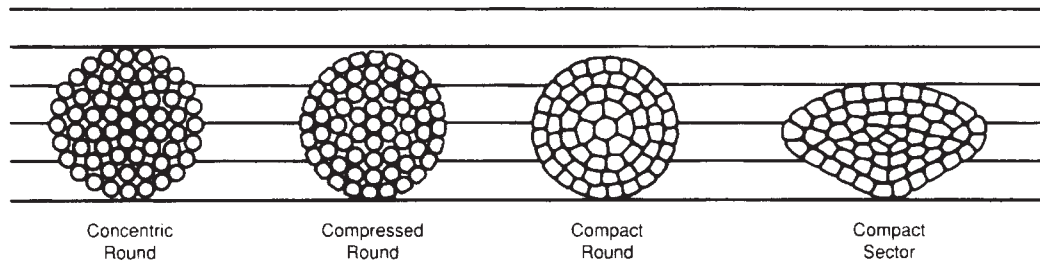

Figure 2-1
Comparative Sizes and Shapes of 61 Strand Conductors

The stranding of conductors is the formation of solid individual wire strands into a composite construction to achieve a specified cross-sectional area. The number of strands is usually based on a geometric progression of single strand layers (1, 6, 12, 18, etc.). The stranded constructions can be conventional concentric or unidirectional concentric stranding as shown in Figure 2-2.

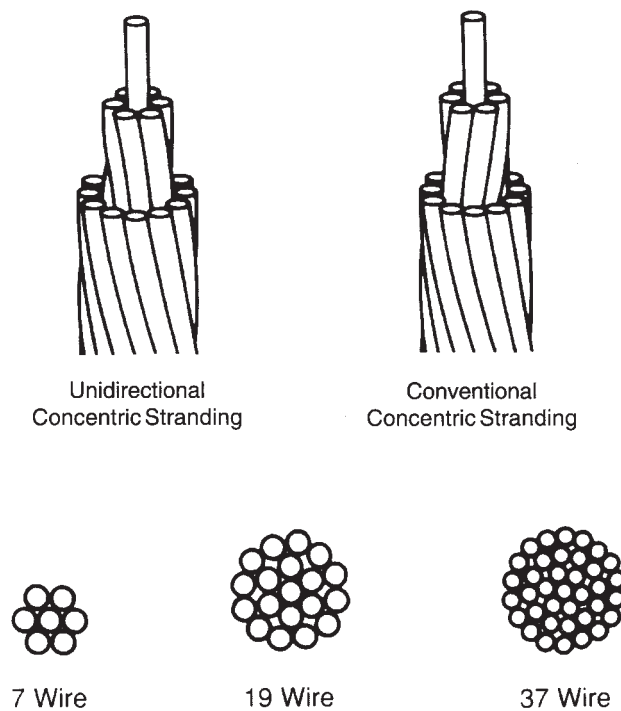

Figure 2-2
Concentric Stranding Constructions

Unilay Stranded Conductors

The 19-wire combination unilay stranded construction has an outer diameter equal to the compressed stranded equivalent conductor. This construction is depicted in Figure 2-3 as presented in ASTM volume 2.03, Standards B 786 and B 787. Note the interstices of the outer strand layer are partially occupied by strands of a lesser diameter.

Compressed unilay stranding is about three percent smaller in diameter than an equivalent compressed conductor made with traditional reverse-lay techniques. This construction is shown in Figure 2-3 and is specified in ASTM volume 2.03, Standards B 8 and B 231. In this construction, one or more of the layers may consist of shaped strands and may also be compressed overall. The diameter of compressed unilay is included in Table 2-2.

Figure 2-3

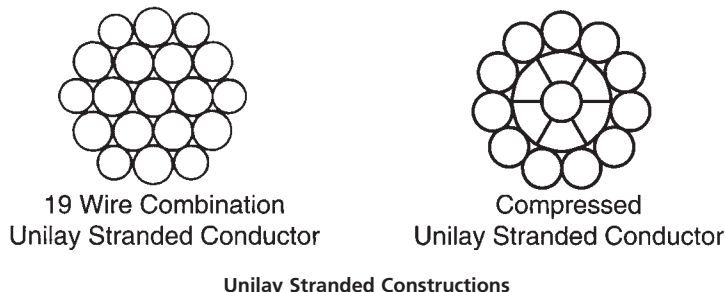

CONDUCTOR CHARACTERISTICS

Copper and Aluminum Properties

Table 2-1 provides pertinent mechanical, physical, and electrical properties of copper and aluminum conductor materials.

TABLE 2-1

PROPERTIES OF COPPER AND ALUMINUM

Property	Unit	Copper		Aluminum
		Annealed	Hard-Drawn 1350	One-Half Hard 8000
Volume electrical conductivity at 20°C	%IACS	100.00	61.2	61.0
Density at 20°C	grams/cm ³	8.890	2.705	2.710
	lb/in ³	0.32117	0.0975	0.0980
Weight Resistivity at 20°C	ohms-lb/mil ²	875.20	434.81	436.23
	ohms-g/m ²	0.153280	0.076149	0.076399
Volume Resistivity at 20°C	ohms-cmil/ft	10.371	16.946	17.002
	at 25°C	ohms-cmil/ft	10.571	17.291
at 20°C	ohms-mm ² /m	0.017241	0.028172	0.028265
	at 20°C	microhms-cm	1.7241	2.8172
Temperature coefficient of resistance at 20°C	°C	0.00393	0.00404	0.00403
	°C	0.00385	0.00396	0.00395
Melting Point	°C	1083	652-657	
	°F	1981.4	1205-1215	
Temperature Coefficient of linear expansion	°C	17.0 x 10 ⁻⁶	23.0 x 10 ⁻⁶	
	°F		9.4 x 10 ⁻⁶	12.8 x 10 ⁻⁶

Conductor Diameters

Table 2-2 provides nominal diameters of both copper and aluminum conductors from 14 AWG through 1000 kcmil having solid and stranded constructions.¹ For diameters in millimeters, multiply the tabulated dimensions by 25.4 (see next page).

TABLE 2-2

Conductor Size		Nominal Diameters (in)						
		Solid	Compact	Reverse Concentric Compressed	Unilay Compressed	Combination Unilay	Concentric Lay Stranded	
AWG	kcmil						Class B	Class C
14	4.11	0.0641	-	0.071	-	0.071	0.073	0.074
12	6.53	0.0808	-	0.089	-	0.090	0.092	0.093
10	10.38	0.1019	-	0.113	-	0.113	0.116	0.117
8	16.51	0.1285	0.134	0.142	-	0.143	0.146	0.148
6	26.24	0.1620	0.169	0.178	-	0.179	0.184	0.186
4	41.74	0.2043	0.213	0.225	-	0.226	0.232	0.234
3	52.62	0.2294	0.238	0.252	-	0.254	0.260	0.263
2	66.36	0.2576	0.268	0.283	-	0.286	0.292	0.296
1	83.69	0.2893	0.299	0.322	0.313	0.321	0.332	0.333
1/0	105.6	0.3249	0.336	0.362	0.352	0.360	0.373	0.374
2/0	133.1	0.3648	0.376	0.405	0.395	0.404	0.419	0.420
3/0	167.8	0.4096	0.423	0.456	0.443	0.454	0.470	0.471
4/0	211.6	0.4600	0.475	0.512	0.498	0.510	0.528	0.529
	250	0.5000	0.520	0.558	0.542	0.554	0.575	0.576
	300	0.5477	0.570	0.611	0.594	0.607	0.630	0.631
	350	0.5916	0.616	0.661	0.641	0.656	0.681	0.681
	400	0.6325	0.659	0.706	0.685	0.701	0.728	0.729
	450	0.6708	0.700	0.749	0.727	0.744	0.772	0.773
	500	0.7071	0.736	0.789	0.766	0.784	0.813	0.815
	550	0.7416	0.775	0.829	0.804	-	0.855	0.855
	600	0.7746	0.813	0.866	0.840	-	0.893	0.893
	650	0.8062	0.845	0.901	0.874	-	0.929	0.930
	700	0.8367	0.877	0.935	0.907	-	0.964	0.965
	750	0.8660	0.908	0.968	0.939	-	0.998	0.999
	800	0.8944	0.938	1.000	0.969	-	1.031	1.032
	900	0.9487	0.999	1.060	1.028	-	1.093	1.093
	1000	1.0000	1.060	1.117	1.084	-	1.152	1.153

Compact and compressed nominal diameters based on concentric lay stranded Class B construction. Diameters are based on ASTM specifications.

¹ ASTM Standards, volume 02.03 Electrical Conductors, B 231-99, B 496-01, and B 787-01.

**METRIC TABLE 2-2
DIAMETERS FOR COPPER AND ALUMINUM CONDUCTORS**

Conductor Size		Nominal Diameters (mm)						
		Solid	Compact	Reverse Concentric Compressed	Unilay Compressed	Combination Unilay	Concentric Lay Stranded	
AWG or kcmil	mm ²						Class B	Class C
14	2.08	1.63	-	1.80	-	1.80	1.84	1.87
12	3.31	2.05	-	2.26	-	2.29	2.32	2.35
10	5.26	2.588	-	2.87	-	2.87	2.95	2.97
8	8.37	3.264	3.404	3.61	-	3.63	3.71	3.76
6	13.30	4.115	4.293	4.52	-	4.55	4.67	4.72
4	21.15	5.189	5.410	5.72	-	5.74	5.89	5.94
3	26.66	5.827	6.045	6.40	-	6.45	6.60	6.68
2	33.63	6.543	6.807	7.19	-	7.26	7.42	7.52
1	42.41	7.348	7.595	8.18	7.95	8.15	8.43	8.46
1/0	53.49	8.252	8.534	9.19	8.94	9.14	9.47	9.50
2/0	67.42	9.266	9.550	10.3	10.03	10.3	10.6	10.7
3/0	85.03	10.40	10.74	11.6	11.25	11.5	11.9	12.0
4/0	107.2	11.68	12.07	13.0	12.65	13.0	13.4	13.4
250	126.6	12.70	13.21	14.2	13.77	14.1	14.6	14.6
300	152.0	13.91	14.48	15.5	15.09	15.4	16.0	16.0
350	177.4	15.03	15.65	16.8	16.28	16.7	17.3	17.3
400	202.7	16.07	16.74	17.9	17.40	17.8	18.5	18.5
450	228.0	17.04	17.78	19.0	18.47	18.9	19.6	19.6
500	253.4	17.96	18.69	20.0	19.46	19.9	20.7	20.7
550	278.7	18.84	19.69	21.1	20.42	-	21.7	21.7
600	304.0	19.67	20.65	22.0	21.34	-	22.7	22.7
650	329.4	20.48	21.46	22.9	22.20	-	23.6	23.6
700	354.7	21.25	22.28	23.7	23.04	-	24.5	24.5
750	380.0	22.00	23.06	24.6	23.85	-	25.3	25.4
800	405.4	22.72	23.83	25.4	24.61	-	26.2	26.2
900	456.1	24.10	25.37	26.9	26.11	-	27.8	27.8
1000	506.7	25.40	26.92	28.4	27.53	-	29.3	29.3

Conductor Weights

Solid Conductors

Table 2-3 provides diameters and weights of solid copper and aluminum conductors through 1000 kcmil.

TABLE 2-3

SOLID ALUMINUM AND COPPER AREA, DIAMETER, AND WEIGHT					
Size AWG or kcmil	Cross-Sectional Area		Diameter inch	Copper lbs/1000 ft	Aluminum lbs/1000 ft
	Cmil	sq. in.			
14	4,110	0.00323	0.0641	12.4	3.78
12	6,530	0.00513	0.0808	19.8	6.01
10	10,380	0.00816	0.1019	31.43	9.56
8	16,510	0.01297	0.1285	49.98	15.17
7	20,820	0.01635	0.1443	63.03	19.13
6	26,240	0.02061	0.1620	79.44	24.12
5	33,090	0.02599	0.1819	100.2	30.40
4	41,740	0.03278	0.2043	126.3	38.35
3	52,620	0.04133	0.2294	159.3	48.36
2	66,360	0.05212	0.2576	200.9	60.98
1	83,690	0.06573	0.2893	253.3	76.91
1/0	105,600	0.08291	0.3249	319.6	97.00
2/0	133,100	0.1045	0.3648	402.9	122.3
3/0	167,800	0.1318	0.4096	507.9	154.2
4/0	211,600	0.1662	0.4600	640.5	194.4
250	250,000	0.1963	0.5000	-	229.7
300	300,000	0.2356	0.5477	-	275.7
350	350,000	0.2749	0.5916	-	321.6
400	400,000	0.3142	0.6325	-	367.6
450	450,000	0.3534	0.6708	-	413.5
500	500,000	0.3927	0.7071	-	459.4
550	550,000	0.4320	0.7416	-	505.4
600	600,000	0.4712	0.7746	-	551.3
650	650,000	0.5105	0.8062	-	597.3
700	700,000	0.5498	0.8367	-	643.3
750	750,000	0.5890	0.8660	-	689.1
800	800,000	0.6282	0.8944	-	735.1
900	900,000	0.6674	0.9487	-	827.1
1000	1,000,000	0.7066	1.0000	-	918.9

Weights are based on ASTM Volume 2.03 Specifications B 8, B 609, and B 231.

METRIC TABLE 2-3

SOLID ALUMINUM AND COPPER AREA, DIAMETER, AND WEIGHT				
Size AWG or kcmil	Cross-Sectional Area mm²	Diameter mm	Copper kg/km	Aluminum kg/km
14	2.08	1.628	18.5	5.6
12	3.31	2.052	29.4	8.9
10	5.26	2.588	46.8	14.2
8	8.67	3.264	74.4	22.6
7	10.55	3.665	93.8	28.5
6	13.30	4.115	118.2	35.9
5	16.77	4.620	149.1	45.2
4	21.15	5.189	188.0	57.1
3	26.67	5.827	237.1	72.0
2	33.62	6.543	299.0	90.8
1	42.41	7.348	377.0	114.5
1/0	53.49	8.252	475.6	144.4
2/0	67.43	9.266	599.6	182.0
3/0	85.01	10.40	755.9	229.5
4/0	107.2	11.68	953.2	289.3
250	126.7	12.70	-	341.8
300	152.0	13.91	-	410.3
350	177.3	15.03	-	478.6
400	202.7	16.07	-	547.1
450	228.0	17.04	-	615.4
500	253.3	17.96	-	683.7
550	278.7	18.84	-	752.1
600	304.0	19.67	-	820.4
650	329.4	20.48	-	888.9
700	354.7	21.25	-	957.4
750	380.0	22.00	-	1026
800	405.4	22.72	-	1094
900	456.1	24.10	-	1231
1000	506.7	25.40	-	1368

Weights are based on ASTM Volume 2.03 Specifications B 8, B 609, and B 231.

Class B and C Stranded Conductors

Table 2-4 provides diameters and weights of Class B and C stranded copper and aluminum conductors. Class B stranding is recommended for power cable use. Class C stranding is recommended for use where power cable conductors require greater flexibility than Class B stranded conductors.

TABLE 2-4

CONCENTRIC STRANDED ALUMINUM AND COPPER CONDUCTOR DIAMETER AND WEIGHT								
Size	Class B			Class C			Weight	
AWG or kcmil	Number of Strands	Diameter of Strand (mils)	Nominal Outside Diameter (in)	Number of Strands	Diameter of Strand (mils)	Nominal Outside Diameter (in)	Copper lbs/1000 ft	Aluminum lbs/1000 ft
14	7	24.2	0.0726	19	14.7	0.074	12.68	3.86
12	7	30.5	0.0915	19	18.5	0.093	20.16	6.13
10	7	38.5	0.116	19	23.4	0.117	32.06	9.75
8	7	48.6	0.146	19	29.5	0.148	50.97	15.5
7	7	54.5	0.164	19	33.1	0.166	64.28	19.5
6	7	61.2	0.184	19	37.2	0.186	81.05	24.6
5	7	68.8	0.206	19	41.7	0.209	102.2	31.0
4	7	77.2	0.232	19	46.9	0.235	128.9	39.1
3	7	86.7	0.260	19	52.6	0.263	162.5	49.3
2	7	97.4	0.292	19	59.1	0.296	204.9	62.2
1	19	66.4	0.332	37	47.6	0.333	258.4	78.4
1/0	19	74.5	0.373	37	53.4	0.374	325.8	98.9
2/0	19	83.7	0.419	37	60.0	0.420	410.9	124.8
3/0	19	94.0	0.470	37	67.3	0.471	518.1	157.2
4/0	19	105.5	0.528	37	75.6	0.529	653.3	198.4
250	37	82.2	0.575	61	64.0	0.576	771.9	234.3
300	37	90.0	0.630	61	70.1	0.631	926.3	281.4
350	37	97.3	0.681	61	75.7	0.681	1081	327.9
400	37	104.0	0.728	61	81.0	0.729	1235	375.7
450	37	110.3	0.772	61	85.9	0.773	1389	421.8
500	37	116.2	0.813	61	90.5	0.815	1544	468.3
550	61	95.0	0.855	91	77.7	0.855	1698	516.2
600	61	99.2	0.893	91	81.2	0.893	1883	562.0
650	61	103.2	0.929	91	84.5	0.930	2007	609.8
700	61	107.1	0.964	91	87.7	0.965	2161	655.8
750	61	110.9	0.998	91	90.8	0.999	2316	703.2
800	61	114.5	1.031	91	93.8	1.032	2470	750.7
900	61	121.5	1.094	91	99.4	1.093	2779	844.0
1000	61	128.0	1.152	91	104.8	1.153	3088	936.8

Weights and diameters are based on ASTM Volume 2.03 Sections B 8 and B 231.

METRIC TABLE 2-4

CONCENTRIC STRANDED ALUMINUM AND COPPER CONDUCTOR DIAMETER AND WEIGHT									
Size	Area	Class B			Class C			Weight	
AWG or kcmil	mm ²	Number of Strands	Diameter of Strand (mm)	Nominal Outside Diameter (mm)	Number of Strands	Diameter of Strand (mm)	Nominal Outside Diameter (mm)	Copper kg/km	Aluminum kg/km
14	2.08	7	615	1.84	19	373	1.87	18.87	5.74
12	3.31	7	775	2.32	19	470	2.35	30.00	9.12
10	5.26	7	978	2.95	19	594	2.97	47.71	14.5
8	8.67	7	1234	3.71	19	749	3.76	75.85	23.1
7	10.55	7	1384	4.17	19	841	4.22	95.66	29.0
6	13.30	7	1554	4.67	19	945	4.72	120.6	35.7
5	16.77	7	1748	5.23	19	1059	5.31	152.1	46.1
4	21.15	7	1961	5.89	19	1191	5.97	191.8	58.2
3	26.67	7	2202	6.60	19	1336	6.68	241.8	73.4
2	33.62	7	2474	7.42	19	1501	7.52	304.9	92.3
1	42.41	19	1687	8.43	37	1209	8.46	384.6	116.7
1/0	53.49	19	1892	9.47	37	1356	9.50	484.9	147.2
2/0	67.43	19	2126	10.6	37	1524	10.7	611.5	185.7
3/0	85.01	19	2388	11.9	37	1709	12.0	771.0	233.9
4/0	107.2	19	2680	13.4	37	1920	13.4	972.2	295.3
250	126.7	37	2088	14.6	61	1626	14.6	1149	348.7
300	152.0	37	2286	16.0	61	1781	16.0	1379	418.8
350	177.3	37	2471	17.3	61	1923	17.3	1609	488.0
400	202.7	37	2642	18.5	61	2057	18.5	1838	559.1
450	228.0	37	2802	19.6	61	2182	19.6	2067	627.7
500	253.3	37	2951	20.7	61	2299	20.7	2298	696.9
550	278.7	61	2413	21.7	91	1974	21.7	2527	768.2
600	304.0	61	2520	22.7	91	2062	22.7	2758	836.4
650	329.4	61	2621	23.6	91	2146	23.6	2987	907.5
700	354.7	61	2720	24.5	91	2228	24.5	3216	976.0
750	380.0	61	2817	25.3	91	2306	25.4	3447	1047
800	405.4	61	2908	26.19	91	2383	26.21	3676	1117
900	456.1	61	3086	27.79	91	2525	27.76	4136	1256
1000	506.7	61	3251	29.26	91	2662	29.29	4596	1394

Weights and diameters are based on ASTM Volume 2.03 Sections B 8 and B 231.
 Diameters in millimeters are obtained by multiplying values in inches by 25.4.
 Weights in kilograms are obtained by multiplying values in pounds per 1000 feet by 1.4882.

Breaking Strengths

Table 2-5 provides breaking strengths for copper and aluminum stranded conductors.

TABLE 2-5

RATED STRENGTH AND CONCENTRIC LAY CLASS B COPPER AND ALUMINUM CONDUCTORS IN POUNDS						
Size AWG or kcmil	Number of Strands	Copper			Aluminum	
		Hard-Drawn Minimum	Medium-Hard Minimum	Soft-Drawn Annealed Maximum	1350 Hard-Drawn Minimum	8000 Series One-Half Hard Minimum
14	7	-	-	-	-	-
12	7	-	-	-	-	-
10	7	-	-	-	-	-
8	7	777	611	499	-	187
6	7	1288	959	794	563	297
4	7	1938	1505	1262	881	472
3	7	2433	1885	1592	1090	595
2	7	3045	2361	2007	1350	750
1	19	3899	3037	2531	1640	916
1/0	19	4901	3805	3191	2160	1160
2/0	19	6152	4765	4024	2670	1460
3/0	19	7698	5970	5074	3310	1840
4/0	19	9617	7479	6149	4020	2320
250	37	11560	8652	7559	4910	2680
300	37	13870	10740	9071	5890	3210
350	37	16060	12450	10580	6760	3750
400	37	18320	14140	11620	7440	4290
450	37	20450	15900	13080	8200	4820
500	37	22510	17550	14530	9110	5360
550	61	25230	19570	16630	10500	5830
600	61	27530	21350	18140	11500	6360
650	61	29770	22970	18890	11900	6890
700	61	31820	24740	20340	12900	7420
750	61	34090	26510	21790	13500	7950
800	61	36360	28270	23250	14400	8480
900	61	40520	31590	26150	15900	9540
1000	61	45030	35100	29060	17700	10600

Rated strengths are based on ASTM Volume 2.03.

METRIC TABLE 2-5

RATED STRENGTH OF CONCENTRIC LAY CLASS B COPPER AND ALUMINUM CONDUCTORS IN KILOGRAMS (FORCE)						
Size AWG or kcmil	Number of Strands	Copper			Aluminum	
		Hard-Drawn Minimum	Medium-Hard Minimum	Soft-Drawn Annealed Maximum	1350 Hard-Drawn Minimum	8000 Series One-Half Hard Minimum
14	7	-	-	-	-	-
12	7	-	-	-	-	-
10	7	-	-	-	-	-
8	7	353	277	226	-	85
6	7	584	435	360	255	135
4	7	879	683	572	400	214
3	7	1104	855	722	494	270
2	7	1381	1071	910	612	340
1	19	1769	1378	1148	744	415
1/0	19	2223	1726	1447	980	526
2/0	19	2791	2161	1825	1211	662
3/0	19	3492	2708	2302	1501	835
4/0	19	4362	3392	2789	1823	1052
250	37	5244	4061	3429	2227	1216
300	37	6291	4872	4115	2672	1456
350	37	7285	5647	4799	3066	1701
400	37	8310	6414	5271	3375	1946
450	37	9276	7212	5933	3719	2186
500	37	10210	7961	6591	4132	2431
550	61	11444	8877	7543	4763	2644
600	61	12488	9684	8228	5216	2885
650	61	13504	10419	8568	5398	3125
700	61	14433	11222	9226	5851	3366
750	61	15463	12025	9884	6124	3606
800	61	16493	12823	10546	6532	3847
900	61	18380	14329	11862	7212	4327
1000	61	20425	15921	13182	8029	4808

Rated strengths are based on ASTM Volume 2.03.

Rated strengths are obtained by multiplying breaking strength in lbs. by 0.45360

COPPER

Drawing copper rod into a wire results in the work hardening of the finished wire. This causes a soft temper rod to become a higher temper wire. It may be desirable to use a conductor of softer temper in a cable construction. This property can be achieved by an annealing process during or after wire drawing or stranding.

Annealing consists of heating the conductor to the elevated temperatures for specific time periods. Annealing is usually done in an oven or by inline annealers installed on the drawing machines.

The coating or tinning of the conductor strands may be employed for protection of the strands against possible incompatibility with other materials. The conductive coating increases the dc resistance of the stranded conductor.

Tempers

Copper is available in three tempers based on ASTM². These tempers are soft or annealed, medium-hard-drawn, and hard-drawn. Soft or annealed is the most commonly used temper for insulated conductors because of its flexibility. Medium-hard-drawn and hard-drawn tempers are most often used in overhead applications because of their higher breaking strengths.

ALUMINUM

Like copper, aluminum rod hardens when drawn into wire. Annealing may be used to reduce the temper.

Alloys

1350 (formerly EC grade) and 8000 series aluminum alloys are manufactured to meet the chemical and physical requirements of ASTM Standards B 233 and B 800, respectively.³

1350 is primarily used by utilities for overhead and underground cables.

8000 series alloy is designed for cables that are required to meet UL specifications. The 2005 NEC[®] mandates the use of 8000 series aluminum alloys as follows:⁴

310-14. Aluminum Conductor Material. Solid aluminum conductors 8, 10, and 12 AWG shall be made of an AA-8000 series electrical grade aluminum alloy conductor material. Stranded aluminum conductors 8 AWG through 1000 kcmil marked as Type RHH, RHW, XHHW, THW, THHW, THWN, THHN, service-entrance Type SE Style U and SE Style R shall be made of an AA-8000 series electrical grade aluminum alloy conductor material.*

Tempers

Based on ASTM, 1350 aluminum can be provided in five tempers as shown in the following table. The overlapping values show that the same conductor may meet the temper requirements of two classifications.⁵

1350 Aluminum Tempers		PSI x 10 ³	MPa
Full Soft	(H-O)	8.5 to 14.0	59 to 97
1/4 Hard	(H-12 or H-22)	12.0 to 17.0	83 to 117
1/2 Hard	(H-14 or H-24)	15.0 to 20.0	103 to 138
3/4 Hard	(H-16 or H-26)	17.0 to 22.0	117 to 152
Full Hard	(H-19)	22.5 to 29.0	155 to 200

Tempers in megapascals (MPa) are obtained by multiplying pounds per square inch (PSI) by 0.006895.

*Reprinted with permission from NFPA 70-2005, the National Electric Code®, Copyright 2005, National Fire Protection Association, Quincy, MA 02269. This reprinted material is not the complete and official position of the National Fire Protection Association on the referenced subject which is represented only by the standard in its entirety.

² ASTM Standards, volume 02.03 Electrical Conductors, B 1-01, B 2-00, and B 3-01.

³ ASTM Standards, volume 02.03 Electrical Conductors, B 233-03 and B 800-00.

⁴ National Electrical Code (NEC), 2005, NFPA 70.

⁵ ASTM Standards, volume 02.03, B 233-03.

Three-quarter and full-hard are the most common tempers of 1350 used for insulated conductors. 1350 full-hard-drawn temper is most often used in overhead applications because of its higher breaking strengths.

One-half hard is the most often used temper when using an 8000 series alloy for insulated conductors due to its flexibility.

STRAND BLOCK

Water blocked stranded conductors are used to reduce the possibility of premature insulation failure caused by water treeing. This blocking compound prevents moisture migration along the conductor strands.⁶

RESISTANCE TABULATIONS

Resistivity and Conductivity

Conductivity is typically specified in percent. This percent is based on an International Annealed Copper Standard (IACS). This standard was established in 1913 by the International Electrotechnical Commission, specifying the resistance of a copper wire one meter long that weighs one gram. This standard resistance is designated as having 100% conductivity. The conductivity of aluminum is 61% or higher compared to annealed copper of the same cross-sectional area (neglecting stranding and skin effects). It is common to use 61% conductivity for aluminum in power cable applications; utilities use 61.2% for 1350 as specified by ASTM.

The dc resistance per unit length of a conductor can be calculated from:

$$R = K \cdot \frac{\rho}{A} \cdot 1000 \quad \Omega/1000 \text{ feet} \quad (2-1)$$

where: K = 1.02 for class B and C stranded conductors,
and 1 for solid conductors

ρ = volume resistivity in ohms-cm/foot

= 10.575 for uncoated copper at 25°C

= 17.345 for aluminum at 25°C (61% conductivity)

A = cross-sectional area of conductor in cmil

⁶ ICEA T-31-610-1994, "Walter Penetration Reference Test, Sealed Conductor."

DC Resistance Versus Cross-Sectional Area

Table 2-6 provides dc resistance in ohms per 1000 feet for conductors from 14 AWG through 1000 kcmil.

TABLE 2-6

DC RESISTANCE IN OHMS PER 1000 FEET AT 25°C							
Size AWG or kcmil	Solid		Aluminum	Concentric Lay Stranded			Aluminum Class B, C
	Copper			Copper			
	Uncoated	Coated		Uncoated Class B, C	Coated		
					Class B	Class C	
14	2.57	2.67	4.22	2.63	2.79	2.83	4.31
12	1.62	1.68	2.66	1.66	1.72	1.75	2.70
10	1.02	1.06	1.67	1.04	1.08	1.08	1.70
8	0.640	0.659	1.05	0.652	0.678	0.678	1.07
6	0.403	0.414	0.661	0.411	0.427	0.427	0.675
4	0.253	0.261	0.415	0.258	0.269	0.269	0.424
3	0.201	0.207	0.329	0.205	0.213	0.213	0.336
2	0.159	0.164	0.261	0.162	0.169	0.169	0.265
1	0.126	0.130	0.207	0.129	0.134	0.134	0.211
1/0	0.100	0.102	0.164	0.102	0.106	0.106	0.168
2/0	0.0794	0.0813	0.130	0.0810	0.0842	0.0842	0.133
3/0	0.0630	0.0645	0.103	0.0642	0.0667	0.0669	0.105
4/0	0.0500	0.0511	0.0819	0.0510	0.0524	0.0530	0.0836
250	-	-	0.0694	0.0431	0.0148	0.0448	0.0707
300	-	-	0.0578	0.0360	0.0374	0.0374	0.0590
350	-	-	0.0495	0.0308	0.0320	0.0320	0.0505
400	-	-	0.0433	0.0269	0.0277	0.0280	0.0442
450	-	-	0.0385	0.0240	0.0246	0.0249	0.0393
500	-	-	0.0347	0.0216	0.0222	0.0224	0.0354
550	-	-	-	0.0196	0.0204	0.0204	0.0321
600	-	-	-	0.0180	0.0187	0.0187	0.0295
650	-	-	-	0.0166	0.0171	0.0172	0.0272
700	-	-	-	0.0154	0.0159	0.0160	0.0253
750	-	-	-	0.0144	0.0148	0.0149	0.0236
800	-	-	-	0.0135	0.0139	0.0140	0.0221
900	-	-	-	0.0120	0.0123	0.0126	0.0196
1000	-	-	-	0.0108	0.0111	0.0111	0.0177

Resistance taken from ICEA S-95-658/NEMA WC70. Table 2-4.
Concentric lay stranded includes compressed and compact conductors.

Resistance taken from ICEA 5-95-658/NEMA WC70. Table 2-4.

METRIC TABLE 2-6

DC RESISTANCE IN OHMS PER KILOMETER AT 25°C							
Size AWG or kcmil	Solid		Aluminum	Concentric Lay Stranded			Aluminum Class B, C
	Copper			Copper			
	Uncoated	Coated		Uncoated Class B, C	Coated		
					Class B	Class C	
14	8.43	8.76	13.84	8.63	9.15	9.28	14.11
12	5.31	5.51	8.72	5.44	5.64	5.74	8.92
10	3.35	3.48	5.48	3.41	3.54	3.54	5.58
8	2.10	2.16	3.44	2.14	2.22	2.22	3.51
6	1.32	1.36	2.17	1.35	1.40	1.40	2.21
4	0.830	0.856	1.36	0.846	0.882	0.882	1.39
3	0.659	0.679	1.08	0.672	0.699	0.699	1.10
2	0.522	0.538	0.856	0.531	0.554	0.554	0.872
1	0.413	0.426	0.679	0.423	0.440	0.440	0.692
1/0	0.328	0.335	0.538	0.335	0.348	0.348	0.551
2/0	0.260	0.267	0.426	0.266	0.276	0.276	0.436
3/0	0.207	0.212	0.338	0.211	0.219	0.219	0.344
4/0	0.164	0.168	0.269	0.167	0.172	0.174	0.274
250	-	-	0.228	0.141	0.049	0.147	0.232
300	-	-	0.190	0.118	0.123	0.123	0.194
350	-	-	0.162	0.101	0.105	0.105	0.166
400	-	-	0.142	0.0882	0.0909	0.0918	0.145
450	-	-	0.126	0.0787	0.0807	0.0817	0.129
500	-	-	0.114	0.0708	0.0728	0.0735	0.116
550	-	-	-	0.0643	0.0669	0.0669	0.105
600	-	-	-	0.0590	0.0613	0.0613	0.0968
650	-	-	-	0.0544	0.0561	0.0564	0.0892
700	-	-	-	0.0505	0.0522	0.0525	0.0830
750	-	-	-	0.0472	0.0485	0.0489	0.0774
800	-	-	-	0.0443	0.0456	0.0459	0.0725
900	-	-	-	0.0394	0.0403	0.0413	0.0643
1000	-	-	-	0.0354	0.0364	0.0364	0.0581

Concentric lay stranded includes compressed and compact conductors.
Resistance values in ohms per kilometer are obtained by multiplying ohms per 1000 feet by 3.28

Resistance at Other Temperatures

The values of Table 2-6 require a correction factor to obtain the resistance at temperatures other than 25°C. The change in resistance is linear over the temperature range normally encountered in power cable applications.

The basic relationship between the resistance and temperature of conductors is as follows:

$$R_2 = R_1 [1 + \alpha_1 \cdot (T_2 - T_1)] \quad (2-2)$$

where: $R_2 =$ resistance at temperature T_2

$R_1 =$ resistance at initial or reference temperature T_1

$\alpha_1 =$ temperature coefficient of resistance corresponding to T_1 and the metal having resistance R_1

$T_2 =$ temperature at which the resistance R_2 is desired

$T_1 =$ initial or reference temperature

For Copper (Annealed): $\alpha_1 = 0.00385$ at 25°C.

For Aluminum (61% Conductivity): $\alpha_1 = 0.00395$ at 25°C.

Equation (2-2) can be developed into the following:

For Copper:

$$R_2 = R_1 \left[\frac{234 + T_2}{234 + T_1} \right] \quad (2-3)$$

For Aluminum:

$$R_2 = R_1 \left[\frac{228 + T_2}{228 + T_1} \right] \quad (2-4)$$

Typical Calculations

Resistance at 90°C

1/0 AWG Copper, Class B Stranding, Uncoated

$R_1 = 0.102$ ohms/1000 feet from Table 2-6

$T_2 =$ temperature at which resistance R_2 is desired

$T_1 =$ reference temperature of Table 2-6

Using equation (2-3):

$$R_2 = R_1 \left[\frac{234 + T_2}{234 + T_1} \right]$$

$$R_2 = 0.102 \bullet \left[\frac{234 + 90}{234 + 25} \right]$$

$$R_2 = 0.128 \quad \Omega / 1000 \text{ ft.}$$

1/0 AWG Aluminum, Class B Stranding

$$R_1 = 0.168 \text{ ohms/1000 feet from Table 2-6}$$

$T_2 =$ temperature at which resistance R_2 is desired

$T_1 =$ reference temperature of Table 2-6

Using equation (2-4):

$$R_2 = R_1 \left[\frac{228 + T_2}{228 + T_1} \right]$$

$$R_2 = 0.168 \bullet \left[\frac{228 + 90}{228 + 25} \right]$$

$$R_2 = 0.211 \quad \Omega / 1000 \text{ ft.}$$

AC to DC Ratios

The dc resistance values must be corrected for ac operating frequencies. The correction ratio, including skin and proximity effect, is dependant upon whether cables are in air or conduit. Correction ratios vary for the following configurations: (1) for single conductor cables whether the conduit is metallic or nonmetallic and if the sheaths insulate the metallic shields from metallic conduit, (2) for single conductor cables in separate nonmetallic ducts, and (3) for multiconductor cables whether they are nonmetallic-sheathed or not and if they are in air or nonmetallic conduits.

For 60-hertz operation, the ICEA Project 359 Committee Report presents detailed tabulations and calculation references.⁷ Table 2-7 presents typical ac/dc resistance ratios presented in the Project 359 report.

⁷ "Committee Report on AC/DC Resistance Ratios at 60 Cycles," ICEA Project 359, June 1958, reprinted 1973.

**TABLE 2-7
AC/DC RESISTANCE RATIOS AT 60 CYCLES AND 65°C
NONSHIELDED, NONLEADED, 600 VOLT CABLE
THREE SINGLE CABLES INSTALLED IN TRIANGULAR OR CRADLE
FORMATION**

Size AWG or kcmil	NONMETALLIC CONDUIT or "IN AIR" (In Contact) AC/DC RATIO (1) Triangular or Cradle "At Cdr"	(2) Triangular or Cradle "At Cdr"	MAGNETIC CONDUIT AC/DC RATIO (3) Triangular "At Conduit"	(4) Cradle "At Conduit"
COPPER CONDUCTORS				
1	1.01*	1.01*	1.01*	1.01*
1/0	1.01*	1.01*	1.01	1.01
2/0	1.01*	1.01	1.01	1.01
3/0	1.01	1.01	1.01	1.02
4/0	1.01	1.02	1.02	1.03
250	1.01	1.02	1.03	1.04
300	1.02	1.03	1.05	1.05
350	1.03	1.05	1.06	1.07
400	1.04	1.06	1.08	1.09
500	1.06	1.10	1.13	1.14
600	1.08	1.14	1.17	1.19
700	1.11	1.19	1.23	1.25
750	1.13	1.22	1.26	1.29
800	1.15	1.25	1.30	1.32
900	1.19	1.31	1.37	1.40
1000	1.22	1.38	1.44	1.47
ALUMINUM CONDUCTORS				
1	1.01*	1.01*	1.01*	1.01*
1/0	1.01*	1.01*	1.01*	1.01*
2/0	1.01*	1.01*	1.01*	1.01
3/0	1.01*	1.01*	1.01	1.01
4/0	1.01*	1.01	1.01	1.01
250	1.01	1.01	1.01	1.02
300	1.01	1.01	1.02	1.02
350	1.01	1.02	1.03	1.03
400	1.01	1.02	1.03	1.04
500	1.02	1.04	1.05	1.06
600	1.03	1.05	1.07	1.08
700	1.05	1.08	1.10	1.11
750	1.05	1.09	1.11	1.13
800	1.06	1.10	1.13	1.14
900	1.07	1.13	1.16	1.18
1000	1.09	1.16	1.20	1.22

NOTES:

1.01 with an asterisk(*) indicates that inductive effect is less than 1%.

The "At Cdr" ratios of column (1) allow for "In Air" Conductor Skin-Proximity only. The "At Cdr" ratios of column (2) allow for Conductor Skin-Proximity Effect in Magnetic (Steel) Conduit. The "At Conduit" ratios in columns (3) and (4) allow for the combined effect of Conductor Skin-Proximity Effect, in Magnetic (Steel) Conduit, and Conduit Loss Effect. The ratios indicated above are applicable for cables with rubber, rubber-like, and thermoplastic insulations.

Above ratios based on the following constructional details:

Conductor

Concentric Round Diameters from AEIC

Insulation Thickness

1 through 4/0 AWG	78 mils
250 through 500 kcmil	94 mils
600 through 1000 kcmil	109 mils

Conduit Dimension

	Diameter-Inches	
	Nominal	Inside
1 through 3/0 AWG	2.0	2.07
4/0 AWG Through 250 kcmil	2.5	2.47
300 through 500 kcmil	3.0	3.07
600 through 700 kcmil	3.5	3.55
750 through 1000 kcmil	4.0	4.03

For frequencies other than 60 hertz, a correction factor⁸ (x) is provided by:

$$x = 0.027678 \cdot \sqrt{\frac{f}{R_{dc}}} \quad (2-5)$$

where: f = frequency in hertz

R_{dc} = conductor resistance, dc, at operating temperature in ohms/1000 feet

Table 2-8 derived from the National Bureau of Standards Bulletin 169, provides the factors for a skin effect ratio of R/R_0 as a function of a correction factor (x) where R_0 is the dc resistance and R is the ac resistance. Thus, to determine conductor resistance at a frequency other than 60 hertz, calculate the correction factor from equation (2-5). Using Table 2-8, enter the calculated correction factor to determine the R/R_0 ratio. Use this ratio to multiply the dc resistance of the conductor to obtain the resistance at frequency (f).

⁸ 1957 EEI UGSRB.

TABLE 2-8
RESISTANCE RATIO DUE TO SKIN EFFECT

x	R/R ₀	x	R/R ₀
0.0	1.00000	6.6	2.60V313
0.1	1.00000	6.8	2.67312
0.2	1.00001	7.0	2.74319
0.3	1.00004	7.2	2.81334
0.4	1.00013	7.4	2.88355
0.5	1.00032	7.6	2.95380
0.6	1.00067	7.8	3.02411
0.7	1.00124	8.0	3.09445
0.8	1.00212	8.2	3.16480
0.9	1.00340	8.4	3.23518
1.0	1.00519	8.6	3.30557
1.1	1.00758	8.8	3.37597
1.2	1.01071	9.0	3.44638
1.3	1.01470	9.2	3.51680
1.4	1.01969	9.4	3.58723
1.5	1.02582	9.6	3.65766
1.6	1.03323	9.8	3.72812
1.7	1.04205	10.0	3.79857
1.8	1.05240	10.5	3.97477
1.9	1.06440	11.0	4.15100
2.0	1.07816	11.5	4.32727
2.1	1.09375	12.0	4.50358
2.2	1.11126	12.5	4.67993
2.3	1.13069	13.0	4.85631
2.4	1.15207	13.5	5.03272
2.5	1.17538	14.0	5.20915
2.6	1.20056	14.5	5.38560
2.7	1.22753	15.0	5.56208
2.8	1.25620	16.0	5.91509
2.9	1.28644	17.0	6.26817
3.0	1.31809	18.0	6.62129
3.1	1.35102	19.0	6.97446
3.2	1.38504	20.0	7.32767
3.3	1.41999	21.0	7.68091
3.4	1.45570	22.0	8.03418
3.5	1.49202	23.0	8.38748
3.6	1.52879	24.0	8.74079
3.7	1.56587	25.0	9.09412
3.8	1.60314	26.0	9.44748
3.9	1.64051	28.0	10.15422
4.0	1.67787	30.0	10.86101
4.1	1.71516	32.0	11.56785
4.2	1.75233	34.0	12.27471
4.3	1.78933	36.0	12.98160
4.4	1.82614	38.0	13.68852
4.5	1.86275	40.0	14.39545
4.6	1.89914	42.0	15.10240
4.7	1.93533	44.0	15.80936
4.8	1.97131	46.0	16.51634
4.9	2.00710	48.0	17.22333
5.0	2.04272	50.0	17.93032
5.2	2.11353	60.0	21.46541
5.4	2.18389	70.0	25.00063
5.6	2.25393	80.0	28.53593
5.8	2.32380	90.0	32.07127
6.0	2.39359	100.0	35.60666
6.2	2.46338		
6.4	2.53321		

Examples

- Given 1000 kcmil copper, uncoated Class B strand
- From Table 2-6, $R_{dc} = 0.0108$ ohms per 1000 ft.
- Find resistance at 50 and 400 hertz

For 50 Hz

Using equation (2-5):

$$x = 0.027678 \cdot \sqrt{\frac{50}{0.0108}} = 1.883$$

From Table 2-8, $x = 1.88$ (by interpolation) $R/R_o = 1.0620$

$$R_{50Hz} = R_{dc} \cdot R / R_o$$

$$R_{50Hz} = (0.0108) \cdot (1.0620)$$

$$R_{50Hz} = 0.0115 \quad \Omega / 1000 \text{ ft.}$$

For 400 Hz

Using equation (2-5):

$$x = 0.027678 \cdot \sqrt{\frac{400}{0.0108}} = 5.327$$

From Table 2-8, $x = 5.33$ (by interpolation) $R/R_o = 2.159$

$$R_{400Hz} = R_{dc} \cdot R / R_o$$

$$R_{400Hz} = (0.0108) \cdot (2.159)$$

$$R_{400Hz} = 0.0233 \quad \Omega / 1000 \text{ ft.}$$

INSULATIONS

TYPES

Many insulations are used in producing the various cables used to deliver electric power. Extruded insulations used for wire and cable are classified as either thermoplastic or thermoset material. Thermoplastic materials tend to lose their form upon subsequent heating, while thermosetting materials tend to maintain their form. These insulations range from thermoplastic polyvinyl chloride (PVC) to thermoset cross-linked polyethylene and synthetic rubber compounds.

Polyethylene

Polyethylene (PE) is a long chain hydrocarbon thermoplastic material that is produced by the polymerization of ethylene gas under high or low pressure. PE is popular because of its relatively low price, processability, resistance to chemicals and moisture, electrical properties, and low temperature flexibility. PE is produced in low, linear low, medium, and high densities. As the density increases, so does the hardness, yield strength, stiffness, and heat and chemical resistance.

If PE cables are exposed to sunlight, carbon black or a suitable inhibitor is added to screen out ultraviolet (UV) radiation. UV radiation can degrade both physical and electrical properties. PE's electrical properties are excellent. Typical values for a natural, unfilled insulation compound include a volume resistivity of greater than 10^{16} ohm-cm, a dielectric constant of 2.3, a dissipation factor of 0.0002, and water absorption of less than 0.1%. A disadvantage of PE is that, like most plastics, it is susceptible to degradation by corona discharges. PE also may experience degradation from treeing when it is subjected to high electrical stress. Corona discharges and treeing may lead to premature cable failure.

Cross-linked Polyethylene

Cross-linked polyethylene (XLPE) is a thermoset material normally produced by compounding polyethylene or a copolymer of ethylene and vinyl acetate (EVA) with a cross-linking agent, usually an organic peroxide. The individual molecules of polyethylene join together during a curing process to form an interconnected network. The terms "cure" and "vulcanize" are often similarly used to designate cross-linking.

While the use of peroxide as the cross-linking agent means that only low-density polyethylene or EVA can be cross-linked, silane cross-linking technology allows the cross-linking of all densities of polyethylene. Cables produced with cross-linked polyethylene can operate at higher temperatures than cables produced with thermoplastic or noncross-linked polyethylene.

Cross-linking also significantly improves the physical properties of the polyethylene. Additives tend to reduce the electrical properties of the insulation. For this reason, the EVA copolymer is used only for low voltage applications. For medium voltage applications, cross-linked polyethylene fares well because the dielectric strength of the unfilled cross-linked polyethylene is about the same as that of thermoplastic polyethylene. Impulse strengths of 2700 V/mil are common.

For low voltage applications, the addition of fillers—in particular, medium thermal carbon black—provides increases in tensile strength and hardness. It also provides the necessary ultraviolet protection for outdoor applications without the use of a jacket. The EVA copolymer is well suited to accepting up to a 30% loading of medium thermal carbon black. Between 2% and 3% of very small particle size furnace carbon black can be incorporated into the polyethylene if sunlight resistance is required without significantly reducing the electrical properties.

XLPE-insulated cables may be operated continuously at a conductor temperature of 90°C and intermittently at 130°C during emergency conditions. Based on cable construction, XLPE-insulated cables may be used for conductor temperatures up to 105°C continuously or 140°C during emergency conditions. XLPE has good low temperature properties, shows increased resistance to corona when compared with thermoplastic polyethylene, and has good impact, abrasion, and environmental stress crack resistance.

Medium voltage tree-retardant XLPE insulation compounds are also available. There are two processes for imparting tree resistance to the compound. One involves additives and the other involves copolymer technology. Additives tend to reduce the electrical properties of the polyethylene insulation and one finds slightly lower values of dielectric strength and slightly higher values of the dissipation factor when comparing the tree retardant insulations to the standard materials. Medium voltage XLPE insulation is not flame retardant. For low voltage applications, the compounding of halogen or non-halogen flame retardants into the insulation achieves the required level of flame retardance.

Ethylene-Propylene Rubber

Ethylene-propylene rubber (EPR) is a thermoset material synthesized from ethylene, propylene, and in many instances a third monomer. If only ethylene and propylene are used, the polymer may be referred to as EPM. If three monomers are used, the resulting polymer is called EPDM. However, in general usage, the term EPR is meant to cover either polymer. EPR is the predominant insulation for industrial power cable from 5 to 35 kV.

While XLPE is considered a highly crystalline material, EPR ranges from amorphous to semicrystalline. This range accounts for EPR's increased flexibility when compared to XLPE.

Peroxide is the predominant cross-linking agent for EPR compounds. However, work has been done on the use of silane cross-linking systems. Slower cure sulfur cross-linking systems may be used only if the polymer is EPDM. While XLPE is mainly used as an unfilled insulation, EPR has filler content that can be 50% or more. The filler is typically a treated clay or silicate.

EPR may be used for conductor temperatures up to 90°C continuously or 130°C during emergency conditions. Based on cable construction, EPR-insulated cables may also be used for conductor temperatures up to 105°C continuously or 140°C during emergency conditions. Good elastomeric properties along with good ozone, environmental, and low temperature resistance are characteristic of EPR insulation compounds. For medium voltage applications, electrical properties consisting of a volume resistivity of 10^{16} ohm-cm, a dissipation factor of 0.008, a dielectric constant of 3.2, and an impulse strength of 1500 V/mil are typical. In order to achieve flame retardance, the addition of halogen or non-halogen flame retardants via compounding is required. Medium voltage insulations are generally not flame retardant; however, the overall cable may be.

Polyvinyl Chloride

Polyvinyl chloride (PVC), also called vinyl, is a thermoplastic material introduced in 1932. Since then, PVC has become widely used on wire and cable rated at 1000 volts or less. Vinyl compounds are mechanical mixtures of PVC resin, plasticizers, fillers, stabilizers, and modifiers. The quantity and type of each determines the final properties of the compound.

PVC compounds can be formulated to provide a broad range of electrical, physical, and chemical characteristics. However, in achieving superiority in one property, the other properties are usually compromised. The goal is to optimize the critical property or properties without allowing the secondary properties to fall below acceptable levels.

PVC has high dielectric strength and good insulation resistance. It is inherently tough and resistant to flame, moisture, and abrasion. Resistance to ozone, acids, alkalies, alcohols, and most solvents is also adequate. Compounding can impart resistance to oils and gasoline. Based on specific formulation, temperature ratings range from 60°C to 105°C.

Disadvantages of PVC include a relatively high dielectric constant and dissipation factor. Plasticizer loss through evaporation or leeching eventually may cause embrittlement and cracking. PVC compounds significantly stiffen as temperatures decline, and are not generally recommended for uses which require flexing below -10°C. However, special formulations have been developed that will allow flexing to -40°C.

Chlorosulfonated Polyethylene

Chlorosulfonated polyethylene (CSP) is a thermoset material commonly referred to by DuPont's trade name of Hypalon®. Several abbreviations are used for this material. ASTM, in D 1418, refers to it as CSM and UL uses the letters CP. In this section, we will refer to it by the commonly used letters of CSP.

DuPont began initial work on CSP in the early 1940s. Commercial insulation compounds appeared a few years later. CSP is made by adding chloride and sulfonyl groups to polyethylene. This modification changes the stiff plastic into a rubbery polymer that can be cross-linked in a variety of ways. Organic peroxides and sulfur systems are the most common methods of obtaining the cross-linking.

Like PVC and XLPE, CSP is a mechanical mixture of ingredients that may contain polymer, fillers, modifiers and cross-linking agents. The quantity and type of each ingredient affects the final physical and electrical properties of the insulation. Because CSP contains a halogen, it is inherently flame retardant. The typical CSP compound is rated for 90°C operation and has excellent mechanical properties such as tensile strength and abrasion resistance. In addition, it has good weather, oil, chemical, and fluid resistance.

Non-Halogen Ethylene Copolymers

Non-halogen ethylene copolymers combine attributes of polyethylene and polypropylene to produce insulating and jacketing compounds with superior fire performance. Unlike many other ethylene copolymers, these compounds do not include chemicals from the halogen group of elements, such as fluorine, chlorine, bromine, and iodine. Compounds made with halogens are more likely to give off toxic or acid by-products when burned.

Non-halogen ethylene copolymers are the result of many years of research. They are generally more expensive than materials such as PVC and XLPE. Manufacturers generally do not reveal the formulas or processes they use to make non-halogen ethylene copolymer insulations.

These compounds feature good fire performance characteristics: low smoke production, delayed ignition, and little or no production of toxic by-products or acid gases.

The fire retardant system for these copolymers is not the same as for PVC or XLPE. Non-halogen ethylene copolymers include hydrated minerals that release water when exposed to elevated temperatures. The water cools the burning mass to a point below its combustion temperature, extinguishing the flame. The emission from the flaming material is steam, not the black smoke produced by burning conventional materials.

These characteristics improve the potential of escape from fires and lower the likelihood of equipment damage due to smoke. Because non-halogen ethylene copolymer products are more expensive, they are primarily used for installations in which the benefit of the additional fire performance outweighs the cost, such as computer rooms.

In properties other than fire performance, non-halogen ethylene copolymers perform much like PVC or XLPE. In terms of performance criteria such as flexibility, a user would be unlikely to notice any difference in non-halogen ethylene copolymers versus other materials. However, in terms of electrical characteristics, non-halogen ethylene copolymers do exhibit one key difference: These materials are required to provide electrical resistance 10 times greater than PVC to ensure the integrity of the compound.

INSULATION PROPERTIES

TABLE 3-1
INSULATION PROPERTIES

	Units	PVC	HMWPE ^A	LLDPE ^A	HDPE ^A	XLPE ^B	MVXLPE	EPR	CSP	LSZH
Service Temperature (Max)	°C	105	75	75	75	90	90	90	90	90
Tensile Strength	PSI	3000	2100	2250	4000	2400	2400	1400	1700	1800
Elongation	%	300	650	650	800	350	550	300	500	200
Specific Gravity		1.32	0.93	0.93	0.96	1.07	0.92	1.19	1.54	1.5
Abrasion Resistance	Rel ^C	Good	Good	Good	Good	Good	Good	Fair	Good	Good
Ozone Resistance	Rel ^C	Good	Good	Good	Good	Good	Good	Good	Good	Good
Flame Resistance	Rel ^C	Fair	Poor	Poor	Poor	Poor	Poor	Poor	Good	Good
Flexibility	Rel ^C	Fair	Poor	Poor	Poor	Poor	Poor	Good	Good	Poor
Dielectric Constant		3.4	2.6	2.5	2.5	5.0	2.3	2.5	6.0	4.0
Dissipation Factor		0.1	0.005	0.003	0.001	0.006	0.0003	0.005	0.06	0.003
Insulation Resistance ^D	IR K	2000	50000	50000	50000	10000	20000	20000	1000	10000
Volume resistivity (Min)	ohm-cm	1E + 14	1E +16	1E +16	1E +16	1E +16	1E +16	1E +15	1E +14	1E +16
Dielectric Strength (ac)	V/mil	500	500	500	500	390	1000	900	500	500
Acid Resistance	Rel ^C	Good	Good	Good	Good	Good	Good	Good	Good	Good
Alkali Resistance	Rel ^C	Good	Good	Good	Good	Good	Good	Good	Good	Good
Organic Solvent Resistance	Rel ^C	Fair	Poor	Fair	Fair	Fair	Fair	Fair	Good	Fair
Hydraulic Fluid Resistance	Rel ^C	Good	Poor	Fair	Fair	Fair	Good	Good	Good	Fair
Motor/Crude Oil Resistance	Rel ^C	Good	Fair	Good	Good	Poor	Fair	Poor	Good	Poor
Gasoline/Kerosene Resistance	Rel ^C	Good	Fair	Good	Good	Poor	Fair	Poor	Fair	Poor
Alcohol Resistance	Rel ^C	Fair	Fair	Good	Good	Poor	Fair	Good	Good	Poor

(A) Black pigmented insulation.

(B) Typical carbon black filled 600 volt insulation.

(C) Rel = Relative performance among materials listed.

(D) Minimum ICEA values.

Values are typical unless otherwise indicated.

HMWPE - High Molecular Weight Polyethylene

LLDPE - Linear Low Density Polyethylene

HDPE - High Density Polyethylene

MVXLPE - Medium Voltage Cross-linked Polyethylene

LSZH - Low Smoke Zero Halogen

WALL THICKNESSES

ICEA Insulated Cables

TABLE 3-2

ICEA NONSHIELDED INSULATION THICKNESSES RATED 0 – 2000 VOLTS					
Rated Circuit Voltage, Phase-to-Phase, Volts	Conductor Size, AWG or kcmil	Insulation Thickness			
		Column A		Column B	
		mils	mm	mils	mm
0-600	14-9	45	1.14	30	0.76
	8-2	60	1.52	45	1.14
	1-4/0	80	2.03	55	1.40
	225-500	95	2.41	65	1.65
	525-1000	110	2.79	80	2.03
601-2000	14-9	60	1.52	45	1.14
	8-2	70	1.78	55	1.40
	1-4/0	90	2.29	65	1.65

This information was taken from ICEA Standard S-95-658.

Column A thickness (2000 volts or less) apply to single-conductor power cables for general application when a carbon-black-pigmented insulation is used without a further covering.

Column B thicknesses (2000 volts or less) apply to multiple-conductor cables with an outer covering and to single-conductor cables with an outer covering. The Column B thicknesses are considered adequate for electrical purposes and may be specified for single-conductor cables with a carbon-black pigmented insulation without further covering for applications where installation and service conditions are such that the additional thickness for mechanical protection is not considered necessary for satisfactory operation.

NEC/UL Listed Cables

TABLE 3-3

THICKNESS OF INSULATION AND JACKET FOR NONSHIELDED CABLES RATED 2001 – 5000 VOLTS						
Conductor Size (AWG or kcmil)	Dry Locations, Single Conductor			Wet or Dry Locations		
	Without Jacket	With Jacket		Single Conductor		Multiconductor
	Insulation (mils)	Insulation (mils)	Jacket (mils)	Insulation (mils)	Jacket (mils)	Insulation (mils)
8	110	90	30	125	80	90
6	110	90	30	125	80	90
4-2	110	90	45	125	80	90
1-2/0	110	90	45	125	80	90
3/0-4/0	110	90	65	125	95	90
213-500	120	90	65	140	110	90
501-750	130	90	65	155	125	90
751-1000	130	90	65	155	125	90

This information was taken from the 2005 NEC. The 2005 NEC requires cables to be shielded for systems operating above 2400 Volts.

TABLE 3-4

THICKNESS OF INSULATION FOR SHIELDED CABLES RATED 2,001 – 15,000 VOLTS							
Conductor Size (AWG or kcmil)	2,001 – 5,000 Volts	5,001 – 8,000 Volts			8,001 – 15,000 Volts		
		100% Level	133% Level	173% Level	100% Level	133% Level	173% Level
	mils	mils	mils	mils	mils	mils	mils
8	90	--	--	--	--	--	--
6-4	90	115	140	175	--	--	--
2	90	115	140	175	175	220	260
1	90	115	140	175	175	220	260
1/0-2000	90	115	140	175	175	220	260

THICKNESS OF INSULATION FOR SHIELDED CABLES RATED 15,001 – 35,000 VOLTS									
Conductor Size (AWG or kcmil)	15,001 – 25,000 Volts			25,001 – 28,000 Volts			28,001 – 35,000 Volts		
	100% Level	133% Level	173% Level	100% Level	133% Level	173% Level	100% Level	133% Level	173% Level
	mils	mils	mils	mils	mils	mils	mils	mils	mils
8	--	--	--	--	--	--	--	--	--
6-4	--	--	--	--	--	--	--	--	--
2	--	--	--	--	--	--	--	--	--
1	260	320	420	280	345	445	--	--	--
1/0-2000	260	320	420	280	345	445	345	420	580

**This information was taken from the 2005 NEC.

The selection of the cable insulation level to be used in a particular installation is made on the basis of the applicable phase-to-phase voltage of the circuit and of the general system category (expressed as a percent insulation level) as outlined below:

100 Percent Insulation Level — Cables in this category shall be permitted to be applied where the system is provided with relay protection such that ground faults will be cleared as rapidly as possible but, in any case, within 1 minute. While these cables are applicable to the great majority of cable installations that are on grounded systems, they shall be permitted to be used on other systems for which the application of cables is acceptable, provided that the above clearing requirements are met in completely de-energizing the faulted section.

133 Percent Insulation Level — This insulation level corresponds to that formerly designated for ungrounded systems. Cables in this category shall be permitted to be applied in situations where the clearing-time requirements of the 100 percent level category cannot be met, and yet there is adequate assurance that the faulted section will be de-energized in a time not exceeding 1 hour. Also, they shall be permitted to be used in 100 percent insulation level applications where additional insulation is desirable.

173 Percent Insulation Level — Cables in this category shall be permitted to be applied under the following conditions.

- (1) in industrial establishments where the conditions of maintenance and supervision ensure that only qualified persons service the installation
- (2) where the fault clearing time requirements of the 133 percent level category cannot be met
- (3) where an orderly shutdown is essential to protect equipment and personnel, and
- (4) there is adequate assurance that the faulted section will be de-energized in an orderly shutdown

Also, cables with this insulation thickness shall be permitted to be used in 100 or 133 percent insulation level applications where additional insulation strength is desirable.

SHIELDING OR SCREENING

Shielding (also referred to as screening) of medium and high voltage power cables uses stress control layers to achieve symmetrical dielectric fields within the cable structure (see Chapter 1). For some voltage levels, shielding may be applied over the conductor. At most higher voltage levels, it is applied over the conductor and the insulation. This construction results in the confinement of all the voltage gradients to within the cable structure if the shield over the insulation is at essentially ground potential.

CONDUCTOR SHIELD

The conductor shield is a layer of semiconducting material used to shield out the surface irregularities of the conductor. A conductor shield is usually required on conductors that are to be insulated for rated operation over 2kV. This stress control layer is compatible with the conductor and the cable insulation. Applicable industry specifications define the characteristics of the conductor shield.¹

INSULATION SHIELD

As discussed in Chapter 1, the insulation shield consists of two components. These components are the auxiliary shield and the primary shield, both functioning as stress control layers in concert with each other.

Materials

The **auxiliary shield** is an extrudable semiconducting polymer. It can also serve as a jacketing function as discussed in Chapter 5.

The **primary shield** may consist of metal tape, drain wires, or concentric neutral (CN) wires. These are usually copper and may be coated or uncoated. Some primary shields may consist of a combination of drain wires and a collector tape, which is smaller than a normal shielding tape.

Concentric neutral wires serve a two-fold purpose. They function as the metallic component of the insulation shield and as a conductor for the neutral return current. Their cross-sectional area must be sized in order to function as the neutral conductor.

Chapter 6 has information concerning fault currents in primary shields.

¹ ICEA S-93-639 (NEMA WC 74-2000): "5 - 46 kV Shielded Power Cable for Use in the Transmission & Distribution of Electric Energy." AEIC CS8-00 (1st edition), "Specification for Extruded Dielectric, Shielded Power Cables Rated 5 through 46kV."

Voltage Parameters

With some exceptions, an insulation shield is required by the NEC for all cables rated above 2kV. According to ICEA, a single cable with a metallic sheath and multiple conductor cables with metallic sheath or armor, as well as multiple conductor cables with a discharge-resistance jacket, may operate below 5kV without an insulation shield. ICEA and AEIC provide the required characteristics of the insulation shield.¹

Requirements for Use

In addition to the voltage parameters given above for when an insulation shield must be used, other parameters must be considered to determine when insulation shielding is required on a cable. These requirements are presented in ICEA specifications as follows;²

1. Cable that is connected to an overhead aerial conductor.
2. When the cable length makes a transition from a conducting to a nonconducting enclosure.
 - For example:
 - a. Conducting to nonconducting conduit
 - b. In nonconducting conduit that is alternately dry and wet
 - c. From dry earth to moist earth
3. With the use of pulling lubrications that have conductive properties
4. Where cable surface is subjected to deposits of conducting materials, such as salts, cements, soot, etc.
5. Where there are or may be electrostatic discharges that may not be injurious to the cable but of sufficient magnitude to create radio or television reception interference.

GROUNDING OF INSULATION SHIELD

The grounding of the insulation shield is the electrical connection between the metallic component of the insulation shield and the system ground. The grounding of the insulation shield results in the symmetrical dielectric fields previously discussed. In addition, grounding promotes personnel safety by minimizing potentials on the outer surface of the cable and its accessories. Chapter 6 contains information on grounding of the insulation shield.

The shielding of the cable system can be grounded by either single-point or multiple-point methods. A **single-point grounded system** is frequently referred to as an open circuit shield. Because the shield is grounded at a single point, no closed loop exists for the flow of induced shield currents. A **multiple-point grounded system** is one that has grounds at more than one point. It is frequently called a closed or short circuit shield system.

Each arrangement has its particular advantages and disadvantages for selection. Knowledge of the total system should be taken into account when making these decisions. Chapter 6 and IEEE discuss this topic in more detail.³

¹ ICEA S-93-639 (NEMA WC 74-2000): "5 - 46 kV Shielded Power Cable for Use in the Transmission & Distribution of Electric Energy." AEIC CS8-00 (1st edition), "Specification for Extruded Dielectric, Shielded Power Cables Rated 5 through 46kV."

² ICEA S-93-639 (NEMA WC 74-2000): "5 - 46 kV Shielded Power Cable for Use in the Transmission & Distribution of Electric Energy."

³ ANSI/IEEE Standard 525-1992, "IEEE Guide for the Design and Installation of Cable Systems in Substations. 1992."

Single-Point Grounding

An ampacity improvement may be achieved if the primary shield is grounded at only one point. Any improvement is also dependent upon conductor size, cable spacing, and shield resistivity (see Chapter 6). The major reason for improvement is the elimination of induced circulating currents through a shield ground-neutral loop. Current is induced in the shield by the electromagnetic field produced by the load current in the conductor. The shield voltage is sufficient to drive this current through any loop of shield-ground-neutral-conductors. Opening the loop by grounding the shield at only one point stops this circulating current flow.

Single-point grounding will result in an increasing voltage along the shield. The value of this buildup of voltage is influenced by the electromagnetic field created by the load current in the power conductor and the length of the shield. To keep the voltage at the ungrounded end of the shield to the recommended maximum level of 25 volts, it may be necessary to ground the shield at the midsection of the cable route. When using the midsection grounding method, the cable length to achieve a 25 volt buildup is double that if the shield were grounded at only one end.

To keep shield potentials to desirable voltage levels, it may be necessary to install shield interrupters to create shield sections, which then are grounded at only one end. This “interrupts” the shield to ground circulating current because of the “open” in the shield-ground-neutral loop.

Shield interrupts require the construction of unconnected, overlapping cable insulation shields. Splices provide convenient opportunity for either the placement of shield interrupts or the incorporation of a shield interrupt into the design and installation.

Multiple-Point Grounding

To keep shield potentials at a minimum, it is common practice to ground insulation shields at readily accessible locations, such as at every splice and termination. It must be recognized that multiple-point grounding creates shield-to-ground circulating currents and may have an adverse effect upon cable ampacity. This effect is also dependent upon conductor size, cable spacing, current loading of cable conductor, and shield resistivity. For more details, refer to Chapter 6.

JACKETING, SHEATHING, AND ARMORING

GENERAL

Jackets, also called sheaths, serve several purposes. For example, they provide mechanical, thermal, chemical, and environmental protection to the insulated conductors they enclose. They may act as electrical insulation when used over shields or armor. They ease installation and routing concerns by enclosing multiple insulated conductors. They may also protect the characteristics of the underlying insulation. For example, a thin nylon jacket over PVC enhances the abrasion and fluid resistance of a 600V cable.

Sheathing may also include various forms of metallic armoring, tapes, or wires to enhance the physical properties of the cable and to provide a built-in protective electrically grounded conduit for the insulated conductors. The term “sheathing” is typically used to identify tubular metallic coverings.

Armoring is primarily used to protect the cable mechanically and adds strength to the cable. Hazards to the cable include penetration by sharp objects, crushing forces, and damage from gnawing animals or boring insects. High pulling or application tensions such as submarine, riser, and down-hole installations also may cause damage.

The distinctions between jackets, sheaths, armoring, and shields are sometimes obscure. For example, an overall welded metal covering usually referred to as a sheath may act as armor and a shield. If it is performing as a jacket, it keeps out water and other contaminants. The covering could be acting as armor because it provides mechanical protection to the insulated conductors. It also performs the function of a shield because it may carry short circuit return currents, help eliminate electrical interference problems, or “shield” the cable from damage caused by lightning strikes.

NONMETALLIC JACKETS

Commonly used jacketing materials include extrusions of PE, PVC, Nylon, CPE (chlorinated polyethylene), non-halogen, and CSP (Hypalon®). PVC, Nylon, PE, and CPE are applied using thermoplastic extrusion lines that heat the material to the melting point and form it over the core. The material is then cooled, usually in a water trough, and wound onto a reel. CSP differs because it is a thermoset material. Some heat is used to soften the material so that it can be formed around the core. It is then necessary to cross-link the material to obtain its full properties. The terms “cure” and “vulcanize” are often similarly used to designate crosslinking.

These materials conform to one or more of the standards issued by AEIC, ASTM, CSA, ICEA, IEEE, NEMA, and UL as directed by specific requirements and applications. Properties for Low Smoke Zero Halogen (LSZH) jackets are found in ICEA.¹

¹ ICEA T-33-655-1994, “Low-Smoke, Halogen-Free (LSHF) Polymeric Cable Jackets.”

TABLE 5-1
JACKET PROPERTY COMPARISON

	Units	PVC	PE	Nylon	CSP	CPE	LSZH
Continuous Service Temp. of Conductors	°C	90	75	90	90	90	90
Installation Temp. (Min)	°C	-10	-40	-10	-20	-40	-20
Tensile Strength (Min)	PSI	1500	1400	7900	1200	1560	1400
Elongation (Min)	%	100	350	40	200	420	100
Specific Gravity		1.43	0.93	1.13	1.54	1.28	1.5
Flexibility	Rel ^A	Fair	Poor	Poor	Good	Fair	Fair
Abrasion Resistance	Rel ^A	Good	Good	Good	Good	Good	Good
Ozone Resistance	Rel ^A	Good	Good	Good	Good	Good	Good
Flame Resistance	Rel ^A	Fair	Poor	Poor	Good	Good	Good
Moisture Resistance	Rel ^A	Good	Good	Poor	Good	Good	Good
Acid Resistance	Rel ^A	Good	Good	Poor	Good	Good	Good
Alkali Resistance	Rel ^A	Good	Good	Good	Good	Good	Good
Organic Solvent Resistance	Rel ^A	Fair	Fair	Good	Good	Good	Fair
Hydraulic Fluid Resistance	Rel ^A	Good	Poor	Good	Good	Good	Good
Motor/Crude Oils	Rel ^A	Good	Fair	Good	Good	Good	Good
Gasoline/Kerosene	Rel ^A	Good	Poor	Good	Good	Good	Good
Alcohol	Rel ^A	Fair	Fair	Good	Good	Good	Good
Hydrocarbons (Halogenated)	Rel ^A	Poor	Poor	Fair	Fair	Poor	Poor

METALLIC SHEATHS

Typical requirements for lead and aluminum sheaths are specified by ICEA and IEEE.²

Lead Sheathing

Lead is one of the oldest sheathing materials used on power cables, dating back in the early 1900s. In the sheathing operation, molten lead is fed into a cylinder. After a partial cooling, a hydraulic piston forces the lead through an annular die, forming it tightly around the cable. A significant advantage of this process is that the lead can be applied to the cable at a relatively low temperature and pressure. Use of lead sheaths has proven to be a very effective moisture barrier contributing to the long-term reliability of cable systems.

A disadvantage of lead sheaths is that they add a great deal of weight to the cable. Lead sheaths also pose environmental concerns. They are prone to deformation under continuous load conditions due to the creep characteristics of the material. Also, lead sheaths are susceptible to failure from metal fatigue caused by mechanical vibration or thermal cycling.

² ICEA S-93-639 (NEMA WC 74-2000): "5 - 46 kV Shielded Power Cable for Use in the Transmission & Distribution of Electric Energy", and IEEE Standard 635-2003, "IEEE Guide for Selection and Design of Aluminum Sheaths for Power Cables."

Aluminum Sheathing

Aluminum sheathing began to appear in the late 1940s. Aluminum is attractive because it is much lighter than lead and has good mechanical properties. Aluminum sheaths may be applied using an extrusion process similar to that used for lead. Aluminum requires significantly higher extrusion temperatures: 450°C compared to 200°C for lead.

An aluminum sheath may also be applied by longitudinally bending a relatively thick metal tape around the core. This tape is then welded and die formed or drawn down to the proper diameter. Corrugations may then be formed into the metal tube for improved bending characteristics.

ARMORING

Typical requirements for continuously corrugated, interlocked, flat tape, and round wire armoring, including required beddings and coverings, appear in ICEA specifications.³

Gas/Vaportight Continuously Corrugated

Gas/Vaportight continuously corrugated metal armor is formed by a flat metal tape that is longitudinally folded around the cable core, seam welded, and corrugated. It can also be manufactured by extruding over the cable core an aluminum tube that is then corrugated. An outer protective jacket, such as PVC, is often used.

The advantage of continuously corrugated armored cable is the sheath is impervious to water and is gas/vaportight. Applications include use as an alternative to traditional conduit systems, aerial installations, direct burial, concrete-encased installations, open trays, troughs, or continuous rigid cable supports. It is approved for Classes I and II, Division 2 and Class III, Divisions 1 and 2 hazardous locations covered under NEC Articles 501, 502, 503, and 505. Continuously corrugated aluminum armor can be used in Class I Division 1 locations if it is jacketed, has appropriate grounding conductors, and is listed for use in Class I and II, Division 1 locations.

Interlocked

Interlocked armor is produced by taking a flat metal tape, preforming it into an approximate "S" shape, and then helically wrapping it around a cable core so that the formed edges lock together. The two most commonly used materials are steel and aluminum. An outer protective jacket, such as PVC, is often used.

Advantages of this type of armored cable include considerable flexibility and relative ease of termination of the armor. A disadvantage is that interlocked armor is not suitable for uses where high longitudinal loads are placed on the armor. Applications include commercial or industrial power, control, and lighting circuits that are installed in conduits, ducts, troughs, and raceways or are suspended from aerial messengers. Although interlocked armor provides excellent mechanical protection and flexibility, it should not be considered as a moisture barrier.

³ ICEA S-93-639 (NEMA WC 74-2000): "5 - 46 kV Shielded Power Cable for Use in the Transmission & Distribution of Electric Energy." Other standards also apply.

Flat Metal Tapes

A flat metal tape is helically wrapped around the cable core. The most commonly used materials are steel, copper, and bronze. The tape is typically protected by an outer covering. Applications include commercial or industrial installations that are installed in conduit, ducts, troughs, and raceways or are suspended from aerial messengers.

Round Wire

Individual wires of relatively small diameter are helically wrapped over the core. Galvanized steel is typically used for protection. An overall extruded thermoplastic jacket may be used for protection. Applications include submarine, borehole, dredge, shaft, and vertical riser cables.

SPECIAL JACKET OR SHEATH COMBINATIONS

Teck Cable

To meet CSA or Ontario Hydro requirements, a double jacketed/interlocked armor design is used. The Canadian terminology refers to this construction as “Teck Cable.” Typically, an extruded PVC jacket is used over the armor. In this special version, an additional PVC jacket is applied over the cable core under the armor. This jacket provides the cable with an extra measure of protection against thermal degradation, mechanical damage, and fluid penetration. In addition, the fully jacketed core can be easily routed and terminated beyond the point where the armor is terminated.

ELECTRICAL CHARACTERISTICS OF CABLES AND CABLE SYSTEM

BASIC POWER SYSTEM REVIEW

DC Circuits

The following circuit diagrams represent selected dc and ac power systems. These diagrams will help in understanding the information presented in this section.

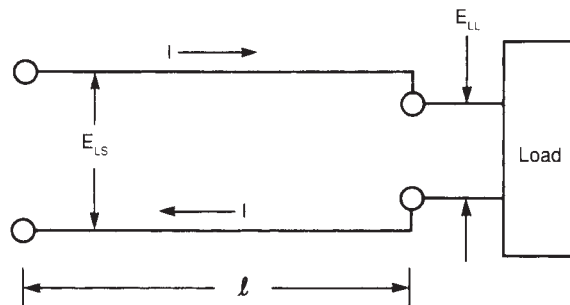

Figure 6-1
DC Two-Wire Circuit

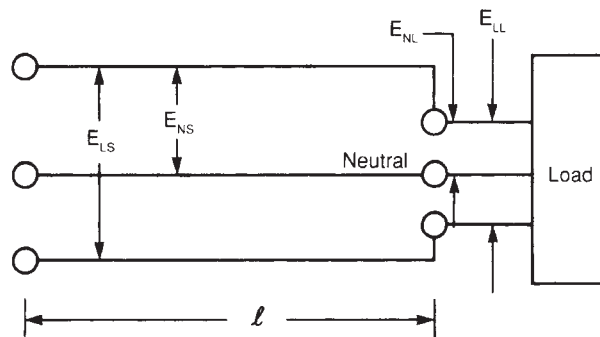

Figure 6-2
DC Three-Wire Circuit

Single-Phase AC Circuits

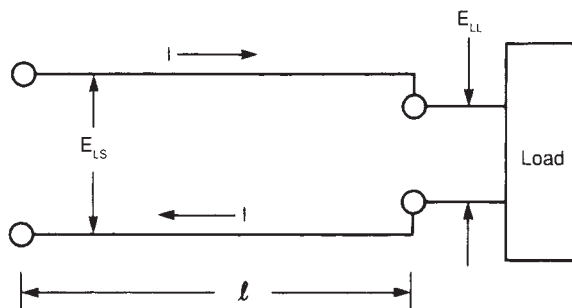

Figure 6-3
AC Single-Phase, Two-Wire Circuit

Polyphase AC Circuits

Polyphase systems merit additional discussion because they are the most common and are somewhat more complex than dc or single-phase ac systems.

Three-Phase Circuits

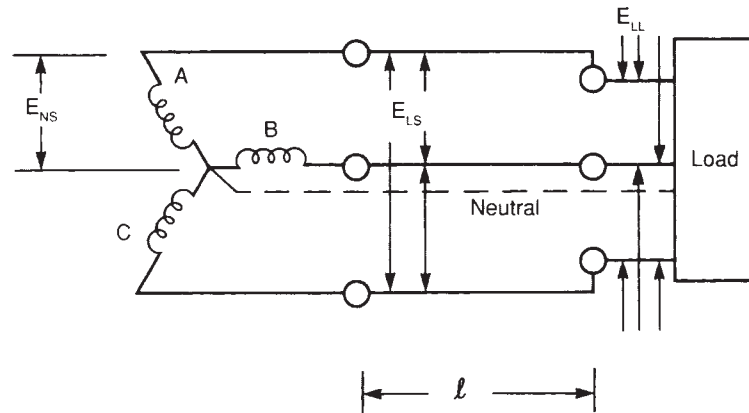

Figure 6-4
AC Three-Phase, Y (Wye) Circuit

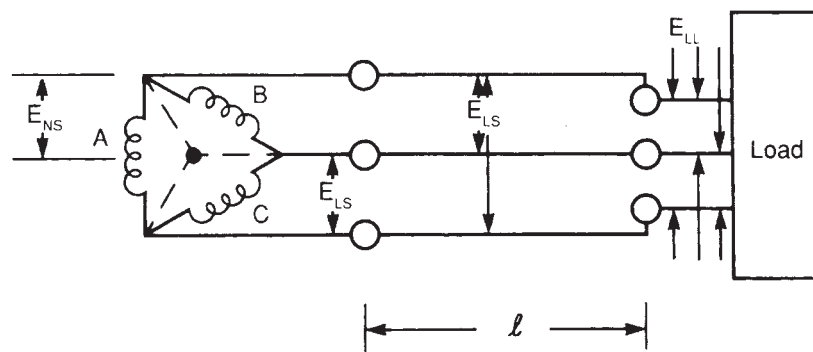

Figure 6-5
AC Three-Phase, Δ (Delta) Circuit

Rotating alternating current generators are typically designed with three armature windings that are spaced 120 physical degrees apart and therefore generate sine wave outputs that are 120 electrical degrees apart. The outputs are connected in a delta (Δ) or wye (Y) configuration. In a Y configuration, the common or neutral point may have a neutral conductor attached. This neutral conductor may be grounded or ungrounded.

With both type circuits, the line voltages and currents are equal when a balanced load is used. A balanced load means that the load is designed to be symmetrical electrically or that diverse, but equal loads are placed on each line, therefore drawing equal currents from each phase.

Two- and Four-Phase Circuits

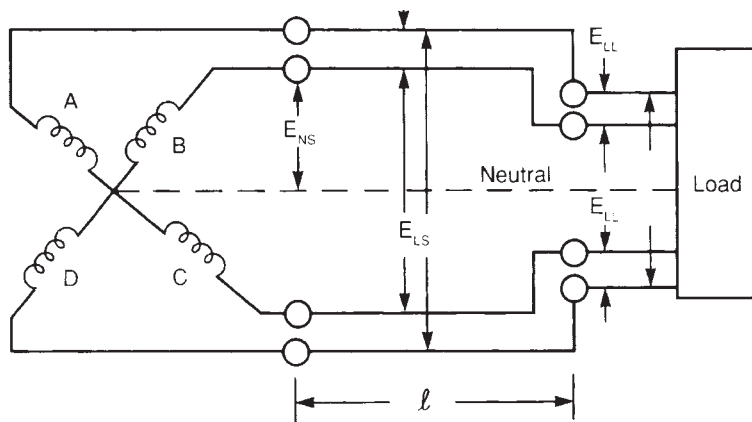

Figure 6-6
AC Two-Phase, Four- or Five-Wire Circuit

These four- or five-wire circuits are variations of the three-phase circuits previously discussed. Typically, the armature windings and resulting outputs are 90 degrees apart. Other configurations can include three-wire, two-phase; four-wire, two-phase; and four-wire with two isolated phases. Eliminating winding A and D in Figure 6-6 would illustrate a three-wire, two-phase circuit.

Advantages of the polyphase circuits include increased generator output, reduced load losses, and constant power output with balanced loads.

VOLTAGE RATING

The voltage rating of a cable is based, in part, on the thickness of the insulation and the type of electrical system to which it is connected. Information on insulation thickness can be found in Chapter 3.

Below are general system categories as defined by the NEC.¹

General System Categories

The selection of the cable insulation level to be used in a particular installation is made on the basis of the applicable phase-to-phase voltage of the circuit and of the general system category (expressed as a percent insulation level) as outlined below:

100 Percent Insulation Level - Cables in this category shall be permitted to be applied where the system is provided with relay protection such that ground faults will be cleared as rapidly as possible but, in any case, within 1 minute. While these cables are applicable to the great majority of cable installations that are on grounded systems, they shall be permitted to be used on other systems for which the application of cables is acceptable, provided that the above clearing requirements are met in completely de-energizing the faulted section.

133 Percent Insulation Level - This insulation level corresponds to that formerly designated for ungrounded systems. Cables in this category shall be permitted to be applied in situations where the clearing-time requirements of the 100 percent level category cannot be met, and yet there is adequate assurance that the faulted section will be de-energized in a time not exceeding 1 hour. Also, they shall be permitted to be used in 100 percent insulation level applications where additional insulation is desirable.

¹ National Electrical Code (NEC), 2005, NFPA 70.

173 Percent Insulation Level - Cables in this category shall be permitted to be applied under the following conditions.

- 1) In industrial establishments where the conditions of maintenance and supervision ensure that only qualified persons service the installation
- 2) where the fault clearing time requirements of the 133 percent level category cannot be met
- 3) where an orderly shutdown is essential to protect equipment and personnel, and
- 4) there is adequate assurance that the faulted section will be de-energized in an orderly shutdown

Also, cables with this insulation thickness shall be permitted to be used in 100 or 133 percent insulation level applications where additional insulation strength is desirable.

Voltage Potentials

The voltage across individual cables in a 23kV three-phase system is as follows:

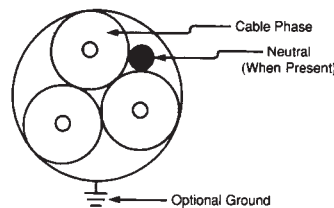

Figure 6-7
Three-Phase Cable Arrangement

$$\begin{aligned}
 E \text{ (Cable A to B)} &= E_{\text{(Line-to-Line)}} = 23,000 \text{ volts} \\
 E \text{ (Cable-to-Ground)} &= E_{\text{(Line-to-Neutral)}} = E_{\text{(Line-to-Line)}} \div \sqrt{3} = 13,200 \text{ volts}
 \end{aligned}$$

However, during a fault on one phase:

$$E \text{ (Cable-to-Ground)} \text{ can approach } E_{\text{(Line-to-Line)}} \text{ or } 23,000 \text{ volts}$$

This illustrates why 133% and 173% level systems require increased insulation thicknesses at certain higher voltage ratings.

FORMULAS AND RELATED INFORMATION

Inductance

This unit inductance (L) of a cable to neutral is dependent on conductor diameter and spacing between the conductors.

$$L = (0.1404 \log_{10} \frac{2s}{d} + 0.0153) \times 10^{-6} \text{ henries for one foot} \quad (6-1)$$

where: s = center-to-center conductor spacing in inches
 d = diameter over conductor in inches

Where the equivalent distance(s) for conductor arrangements is given by

$$s = \sqrt[3]{A \bullet B \bullet C} \text{ inches} \quad (6-2)$$

Inductive Reactance

The inductive reactance (X_L) of a cable system depends on the unit inductance, cable length, and its operating frequency.

$$X_L = 2\pi f L \ell \text{ ohms} \quad (6-3)$$

where: f = frequency in hertz

L = inductance in henries for one foot

ℓ = cable length in feet

The equivalent distance(s) for several conductor arrangements is:

For triplexed cables:

$$s = A$$

where $A = B = C$

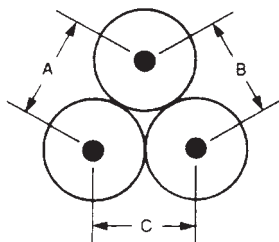

Figure 6-8

For equally spaced flat cables:

$$s = 1.26A$$

where $A = B$

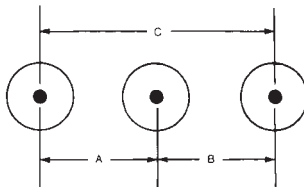

Figure 6-9

For cradled conductors:

$$s \cong 1.15A$$

where $A = B$

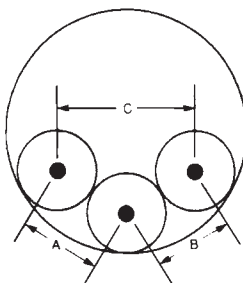

Figure 6-10

Dielectric Constant

The terms dielectric constant, permittivity, and specific inductive capacitance (SIC) are often used interchangeably when discussing cable characteristics. Symbols used are the currently preferred ϵ (epsilon) and the traditional κ (kappa).

The dielectric constant (ϵ) is a specific property of an insulating material that is defined as the ratio of the electrical capacitance of a given capacitor having specific electrode/dielectric geometry to the capacitance of the same capacitor with air as a dielectric.

TYPICAL ϵ VALUES			
Material	Range	Medium Voltage	600V
PVC	3.4 - 8.0	N/A	8.0
EPR	2.5 - 3.5	2.9	3.5
PE	2.5 - 2.6	N/A	2.6
XLPE	2.3 - 6.0	2.4	5.0

Capacitance

The unit capacitance (C) of a cable is dependent on the insulation's dielectric constant and the diameter of the conductor and the insulation.

Shielded Single Conductor

$$C = \frac{7.36\epsilon}{\log_{10} \frac{D}{d}} \text{ picofarads for one foot} \quad (6-4)$$

Twisted Pair (Mutual)

$$C_m = \frac{2.21\epsilon}{\log_{10} \frac{D}{d}} \text{ picofarads for one foot} \quad (6-5)$$

where: ϵ = dielectric constant of the insulation

D = diameter of insulation in inches
(under insulation shield if present)

d = diameter of conductor in inches
(over conductor shield if present)

Capacitive Reactance

The capacitive reactance (X_c) of a cable system is dependent on the unit capacitance and length of the cable and its operating frequency.

$$X_c = \frac{-1}{2\pi f C \ell} \times 10^{12} \text{ ohms} \quad (6-6)$$

where: f = frequency in hertz

C = capacitance in picofarads for one foot

ℓ = cable length in feet

Charging Current

The capacitance of the cable causes a current to flow from the source to ground. This charging current (I_c) is independent of the load current and is usually very small when compared to the load current. Charging current of a cable is dependent on its operating frequency, operating voltage, the unit capacitance, and cable length.

$$I_c = 2\pi f C E_n \ell \times 10^{-12} \text{ amps} \quad (6-7)$$

where: f = frequency in hertz
 C = capacitance in picofarads for one foot
 E_n = line-to-neutral voltage in volts
 ℓ = cable length in feet

Total Reactance

The total cable reactance (X) is the vector sum of the inductive reactance and the capacitive reactance of the cable.

$$X = X_L + X_C \text{ ohms} \quad (6-8)$$

Impedance

Impedance (Z) may be defined as the opposition to the flow of alternating current. The impedance of cables is dependent upon both the resistive and reactive characteristics of the cable.

$$Z = \sqrt{R^2 + X^2} \text{ ohms / foot} \quad (6-9)$$

where: R = ac resistance at operating temperature in ohms per foot
 X = reactance in ohms per foot

Insulation Resistance and IR Constant

Insulation resistance (IR) is the ratio of an applied dc voltage to the small dc current that flows through the insulation to ground. This dc current is commonly called the leakage current.

$$IR = \frac{E}{I_L} \text{ ohms} \quad (6-10)$$

where: E = applied dc voltage in volts
 I_L = leakage current in amps

Insulation resistance measurements are affected by temperature and can be corrected to a base reference temperature with temperature coefficients. The base temperature is usually 60°F.

Insulation Resistance Constant (K)

The minimum insulation resistance (IR) value for a cable can be calculated using an insulation resistance constant (K) based on the insulation used and the applicable specification requirements IR is inversely proportional to cable length. A 2,000 foot length of cable has approximately one-half the IR value of a 1,000 foot length of the same cable.

$$IR = K \log_{10} \frac{D}{d} \text{ Mohms for 1000 feet} \tag{6-11}$$

where: K = specific insulation resistance constant at 60°F

D = diameter of insulation in inches
(under insulation shield if present)

d = diameter of conductor in inches
(over strand shield if present)

TYPICAL K VALUES	
PVC	2,000
EPR	20,000
PE	50,000
XLPE	20,000

Power Factor

The power factor (pf) of a power system can be defined as the percentage of total current flowing from the source that is used to do useful work. A power factor of 1 means that all of the current is used to do work. This represents an ideal situation from the viewpoint of the load. The vector diagram for this would be as shown below:

where: $pf = 1$

$\theta = 0^\circ$ [The angle between E (voltage) and I (current) vectors in degrees]



Figure 6-11

A power factor of 0 means that none of the current is used to do work. A load with a power factor of 0 would be useless because no work would be done. However, a feeder cable with a power factor of 0 is ideal with no lost energy dissipated into the cable. The vector diagram would be as shown below:

where: $pf = 0$

$\theta = 90^\circ$

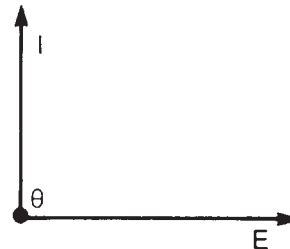
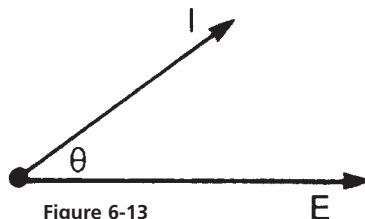

Figure 6-12

A "practical" load has a power factor somewhere between 0 and 1. A typical value would be 0.8. When the power factor is equal to 0.8, the angle θ will equal 36.9° because the power factor is defined as $\cos \theta$. The vector diagram would be as shown below:

$$\text{where: } pf = 0.8$$

$$\theta = 36.9^\circ$$



A "practical" cable has a power factor of 0.1 or less. When the power factor is equal to 0.1, the angle θ will equal 84.3° . Because 90° would be ideal, the imperfection angle, also referred to as the dissipation factor or $\tan \delta$ (δ), is 90° minus 84.3° or 5.7° . The vector diagram would be as shown below:

$$\text{where: } pf = 0.1$$

$$\theta = 84.3^\circ$$

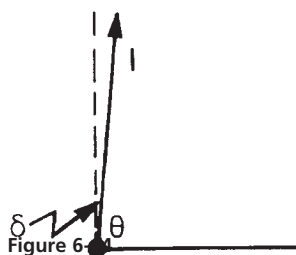

For the small angles found in modern power cables, the $\sin \delta$, $\tan \delta$, and $\cos \theta$ are essentially the same.

Cable System Impedance at Power Frequencies

The cable system impedance (Z) at power frequencies is dependent on the conductor resistance, cable reactance, and the power factor of the load.

$$Z = R \cos\theta + X \sin\theta \text{ ohms} \tag{6-12}$$

where: R = ac resistance of cable conductor at operating temperature in ohms

X = total reactance of cable in ohms

θ = power factor angle of load

Ampere Determination From Power Ratings

DC

$$I = \frac{E}{R} \quad \text{or} \quad I = \frac{kva \cdot 1000}{E} = \frac{kw \cdot 1000}{E} \quad (6-13)$$

AC Single-Phase

$$I = \frac{E}{Z} \quad \text{or} \quad I = \frac{kva \cdot 1000}{E_L} = \frac{kw \cdot 1000}{E_L \cdot pf} \quad (6-14)$$

AC Three-Phase

$$I = \frac{E}{Z} \quad \text{or} \quad I = \frac{kva \cdot 1000}{\sqrt{3} \cdot E_L} = \frac{kw \cdot 1000}{\sqrt{3} \cdot E_L \cdot pf} \quad (6-15)$$

where: kva = apparent power in kilovoltamperes
 kw = power in kilowatts
 E_L = line-to-line voltage
 pf = power factor of load

Breakdown Strength

The electrical breakdown mechanisms of insulation systems are complex. Some of the factors affecting breakdown voltage are the type and condition of the dielectric material, cable design, nature and duration of applied voltage, temperature, and mechanical stresses.

The breakdown voltage strength is defined as the average voltage at which complete electrical failure occurs in the insulation of a given cable. A listing of typical breakdown tests follows. In all of these tests, a sufficient number of specimens must be tested so that a statistically valid average is obtained.

- An **ac or dc fast rise test** is typically done by raising the applied voltage from 0 volts at a uniform and relatively rapid rate until the insulation fails.
- An **ac or dc step rise test** is typically done by applying a fixed voltage to a cable for a fixed time. The voltage is then raised in equal voltage steps and held for equal time increments until the insulation fails.
- **Impulse testing** is done to approximate lightning and other surges that cables may be subjected to in use. An impulse of a standard wave shape is used with the crest value increased until failure.

Voltage Stress

Voltage stress is defined as the voltage across a unit thickness of insulation.

Average Stress (S_A)

The average radial stress is determined by the ratio of the applied voltage to the total insulation thickness.

$$S_A = \frac{E}{t} \quad \text{volts / mil} \quad (6-16)$$

where: E = applied voltage in volts
 t = thickness of insulation in mils

Actual Stress (S)

The cable geometry creates a nonlinear dielectric field. This results in higher radial stresses, or voltage gradients, near the conductor shield when compared to those near the insulation shield.

$$S = \frac{0.868E}{d_x \log_{10} \frac{D}{d_c}} \text{ volts / mil} \quad (6-17)$$

where: E = voltage to ground in volts
 D = diameter over insulation in mils
 (under insulation shield if present)
 d_c = diameter of conductor in mils
 (over strand shield if present)
 d_x = any diameter of interest between d_c and D in mils

The maximum radial stress occurs when d_x is equal to d_c .

VOLTAGE DROP (REGULATION)

Voltage drop (V_d) is the difference in voltage between the source (E_s) and the load (E_L). The feeder cable connects the load to the source and is a major consideration in the calculations. It often happens that voltage drop, not ampacity, is the limiting factor in a given application.

The term voltage regulation (V_r) is often used and is voltage drop expressed as a percentage of the load voltage.

$$V_r = 100 \left(\frac{V_d}{E_L} \right) \text{ percent} \quad (6-18)$$

The following symbols are used in this section:

A, B, C, D = phase windings
 E_S = source voltage
 E_L = voltage at load
 E_{NS} = line-to-neutral voltage at source
 E_{LS} = line-to-line voltage at source
 E_{LL} = line-to-line voltage at load
 E_{PS} = phase voltage at source
 E_{PL} = phase voltage at load
 V_d = voltage drop
 V_N = voltage drop to neutral
 V_L = voltage drop line-to-line
 V_P = voltage drop per phase
 V_r = voltage regulation in percent
 I = line current in amps
 R = dc or ac resistance of cable conductor at operating temperature of the cable in ohms
 X = reactance of cable at power frequencies in ohms
 pf = power factor of load ($\cos \theta$)
 θ = the angle between voltage and current degrees
 Z = cable impedance in ohms
 ℓ = cable length in feet

When calculating voltage drop for ac circuits, the complications of the cable's ac resistance and reactance as well as the power factor of the load must be considered.

The general equation for voltage drop (V_d) is:

$$V_d = E_S - E_L \text{ volts} \quad (6-19)$$

where:

$$E_S = \sqrt{(E_L \cos\theta + IR)^2 + (E_L \sin\theta + I_x)^2} \text{ volts} \quad (6-20)$$

Because E_S is known, the equation can be solved for E_L . V_d can now be calculated. However, without the use of a computer, this is a tedious process.

Where the effect of shunt capacitance is negligible, a good approximation is:

$$V_d = IZ\ell \text{ volts} \quad (6-21)$$

where $Z = \text{cable impedance}$:

$$z = R \cos\theta + X \sin\theta \text{ ohms} \quad (6-12)$$

therefore:

$$V_d = I(R \cos\theta + X_L \sin\theta) \cdot \ell \text{ volts} \quad (6-22)$$

Equations for Basic AC and DC Power Systems

Refer to the power system discussion and circuit diagrams at the beginning of this section.

DC Two-Wire Circuit

Is defined as:

$$V_d = V_L = E_{LS} - E_{LL}$$

or: $V_L = 2 \cdot IR \cdot \ell \text{ volts} \quad (6-23)$

DC Three-Wire Circuit

Is defined as:

$$V_d = V_L = E_{LS} - E_{LL}$$

or: $V_L = 2 \cdot IR \cdot \ell \text{ volts} \quad (6-24)$

Is also defined as:

$$V_d = V_L = E_{NS} - E_{NL}$$

or: $V_N = 2 \cdot IR \cdot \ell \text{ volts} \quad (6-25)$

AC Single-Phase. Two-Wire Circuit

Is defined as:

$$V_d = E_S - E_L$$

or approximately:

$$V_d = 2 \cdot I(R \cos\theta + X_L \sin\theta) \cdot \ell \text{ volts} \quad (6-26)$$

AC Two-Phase, Four- or Five-Wire Circuit

Is defined as:

$$V_N = E_{NS} - E_{NL}$$

or approximately:

$$V_N = I(R \cos\theta + X_L \sin\theta) \cdot \ell \quad \text{volts} \quad (6-27)$$

$$V_L = \sqrt{2} \cdot V_N \quad \text{volts} \quad (6-28)$$

$$V_P = 2 \cdot V_N \quad \text{volts} \quad (6-29)$$

When the load is balanced, the neutral (fifth wire) carries no current; therefore, the equations are the same.

AC Three-Phase Circuits

Is defined as:

$$V_N = E_{NS} - E_{NL}$$

or approximately:

$$V_N = I(R \cos\theta + X_L \sin\theta) \cdot \ell \quad \text{volts} \quad (6-27)$$

$$V_L = \sqrt{3} \cdot V_N \quad \text{volts} \quad (6-30)$$

Typical Calculation

What is the voltage regulation of a feeder circuit consisting of three single conductor, 600 volt cables pulled into a nonmetallic conduit with the following parameters?

$$\begin{aligned} E_s &= 440 \text{ volts, three-phase} \\ I &= 250 \text{ amps} \\ \text{pf (of load)} &= 0.8 \\ \ell &= 750 \text{ feet} \\ R &= 0.063 \times 10^{-3} \text{ ohms/foot at } 75^\circ\text{C} \\ X_L &= 0.037 \times 10^{-3} \text{ ohms/foot} \end{aligned}$$

Using approximate equation (6-27):

$$V_d = V_N = I(R \cos\theta + X_L \sin\theta) \cdot \ell \quad \text{volts}$$

$$V_N = 250 \cdot [(0.0630 \cdot 0.8) + (0.037 \cdot 0.6)] \cdot 10^{-3} \cdot 750 \quad \text{volts}$$

$$V_N = 13.6 \quad \text{volts}$$

and using equation (6-30):

$$V_d = V_L = \sqrt{3} \cdot 13.6 \quad \text{volts}$$

$$V_L = 23.5 \quad \text{volts}$$

Voltage Regulation:

Using equation (6-18):

$$V_r = 100 \cdot \left(\frac{V_d}{E_L} \right) \text{ percent}$$

$$V_r = 100 \cdot \left(\frac{23.5}{440 - 23.5} \right) \text{ percent}$$

$$V_r = 5.64 \text{ percent}$$

SHORT CIRCUIT CURRENTS

Today's high capacity power systems require that the short circuit capabilities of system cables be considered. Calculations can be used to determine an installed cable's ability to withstand various short circuit conditions or the cable size needed to withstand a given short circuit condition.

Conductor Formula

The usual form of the equation used to calculate the conductor's short circuit current (I_{SC}) is presented in ICEA for copper and aluminum conductors.² The equations for calculating short circuit currents for copper and aluminum conductors are presented on the following pages. The accompanying figures graphically depict the relationship between conductor size and short circuit current duration for copper and aluminum conductors with thermoset or thermoplastic insulation. For these equations and curves to be valid, the conductor must be allowed to return to or below the rated maximum operating temperature (T_1) before another short circuit is encountered.

The short circuit current equations may be simplified after designating the conductor metal and the values of T_1 and T_2 as follows:

$$I_{SC} = \frac{AF_C}{\sqrt{t}} \text{ amps} \tag{6-31}$$

where: I_{SC} = short circuit current in amps

A = conductor area in cmil

F_C = conductor short circuit factor from Table 6-1

t = duration of short circuit in seconds

TABLE 6-1
CONDUCTOR SHORT CIRCUIT FACTORS, F_C

Insulation	Copper	Aluminum
Thermoset (XLPE, EPR) $T_1=105^\circ\text{C}$, $T_2=250^\circ\text{C}$	0.0678	0.0443
Thermoset (XLPE, EPR) $T_1=90^\circ\text{C}$, $T_2=250^\circ\text{C}$	0.0719	0.0470
Thermoplastic (PVC, PE) $T_1=75^\circ\text{C}$, $T_2=150^\circ\text{C}$	0.0529	0.0346

Calculation can be made for any value T_1 and T_2 by using (6-32) or (6-33)

² ICEA P-32-382, "Short Circuit Characteristics of Insulated Cable" – Fourth Edition, 1999."

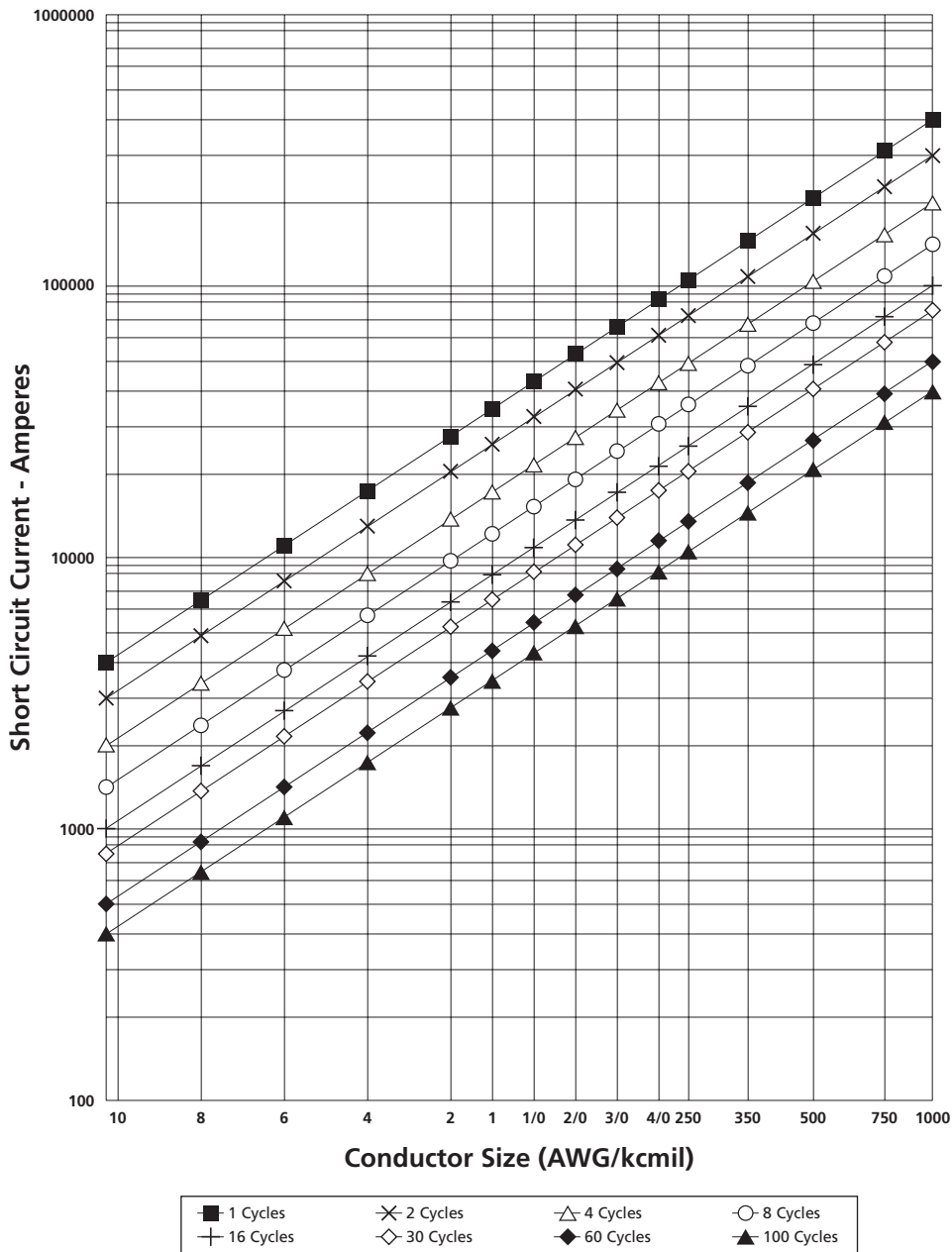

Figure 6-15
Allowable Short Circuit Currents for Thermoplastic Insulated Copper Conductors
Rated 75°C Maximum Continuous Operation

Curves based on the Formula:
$$\left[\frac{I}{A} \right]^2 t = 0.0297 \log \left[\frac{T_2 + 234}{T_1 + 234} \right]$$

Where:

- I = short circuit current - amperes
- A = conductor area - circular mils
- t = time of short circuit - seconds
- T_1 = maximum operating temperature - 75°C
- T_2 = maximum short circuit temperature - 150°C

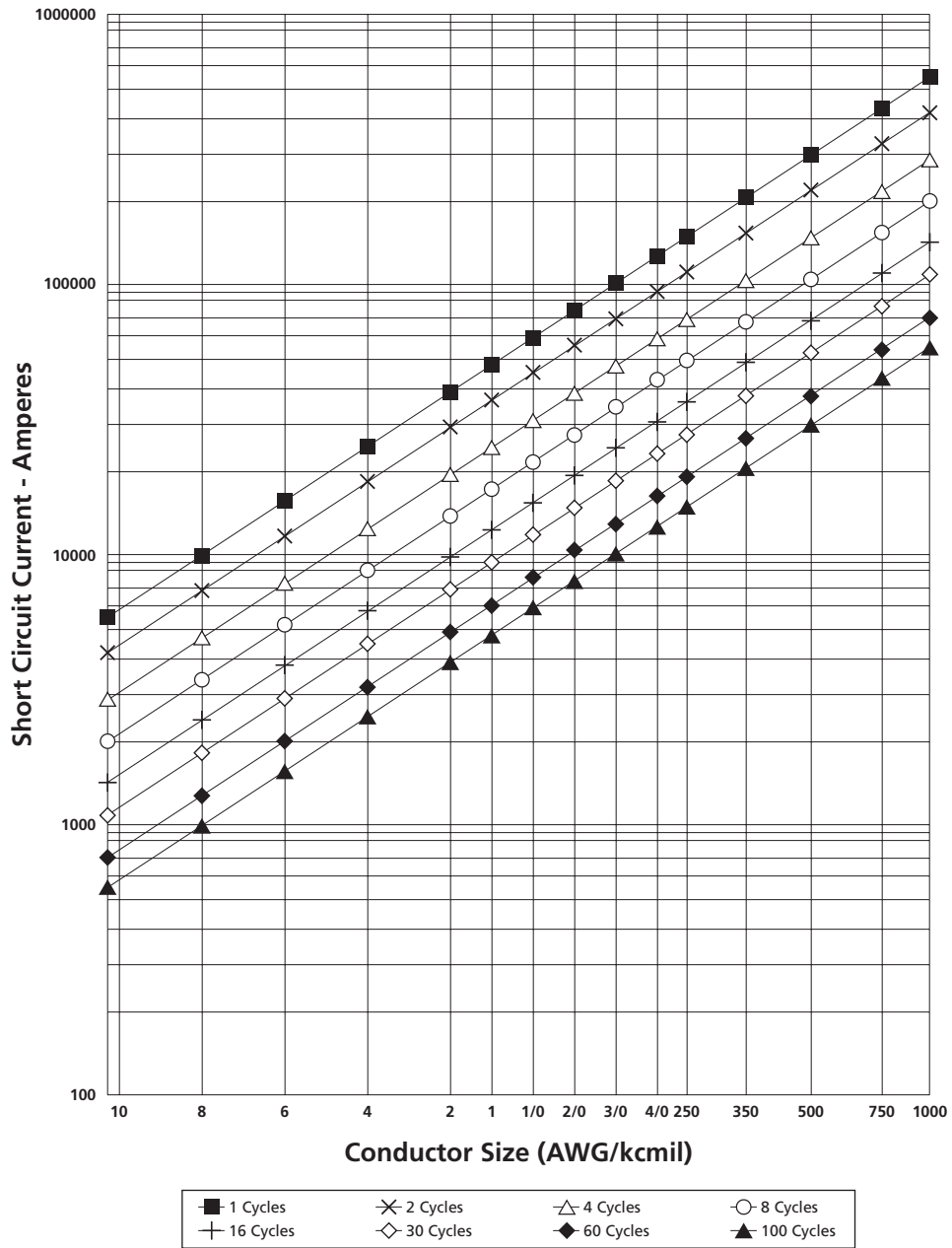

Figure 6-16
Allowable Short Circuit Currents for Thermoplastic Insulated Copper Conductors
Rated 90°C Maximum Continuous Operation

Curves based on the Formula:
$$\left[\frac{I}{A} \right]^2 t = 0.0297 \log \left[\frac{T_2 + 234}{T_1 + 234} \right]$$

Where:

- I = short circuit current - amperes
- A = conductor area - circular mils
- t = time of short circuit - seconds
- T_1 = maximum operating temperature - 90°C
- T_2 = maximum short circuit temperature - 250°C

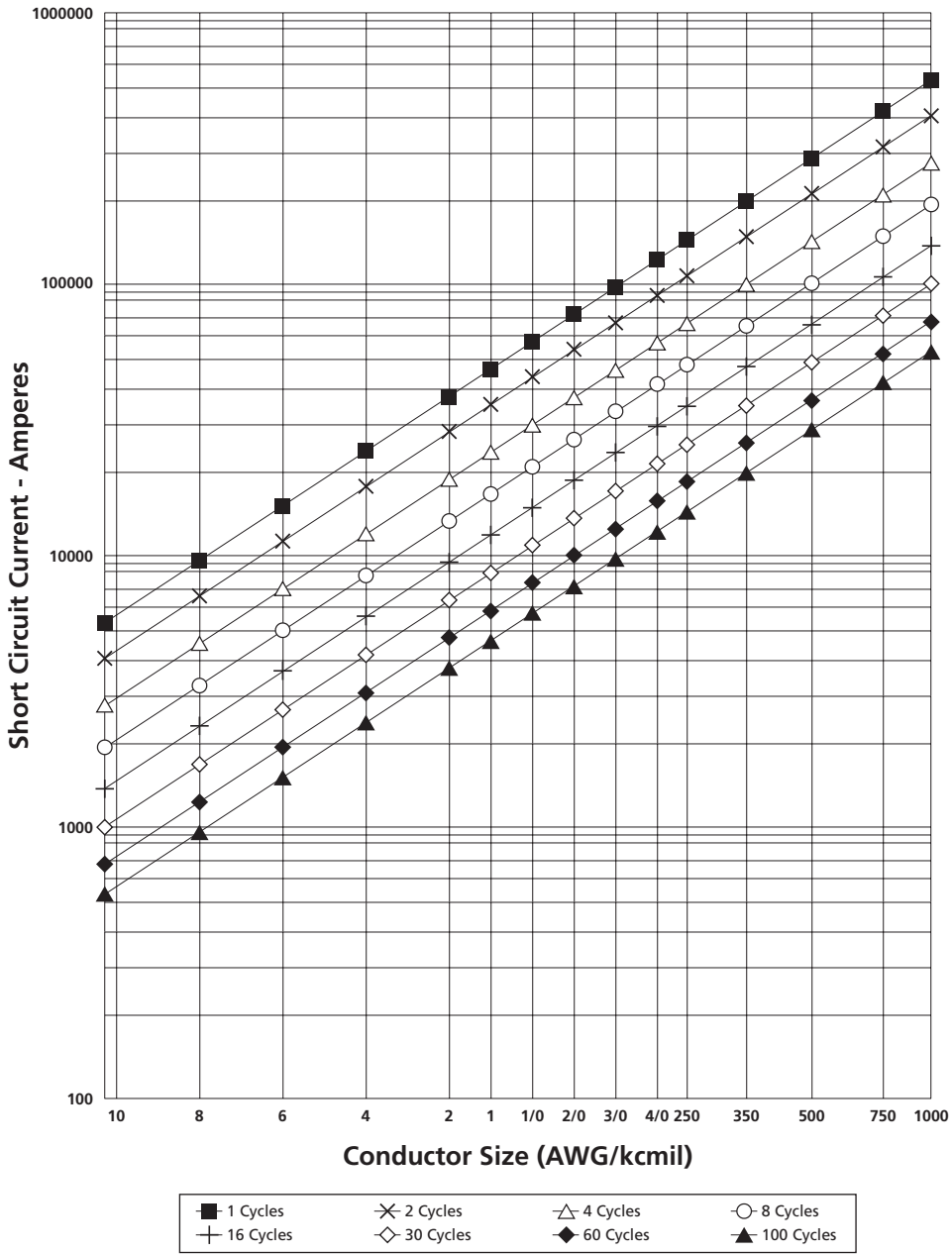

Figure 6-17
Allowable Short Circuit Currents for Thermoplastic Insulated Copper Conductors
Rated 105°C Maximum Continuous Operation

Curves based on the Formula:
$$\left[\frac{I}{A} \right]^2 t = 0.0297 \log \left[\frac{T_2 + 234}{T_1 + 234} \right]$$

Where:

- I = short circuit current - amperes
- A = conductor area - circular mils
- t = time of short circuit - seconds
- T_1 = maximum operating temperature - 105°C
- T_2 = maximum short circuit temperature - 250°C

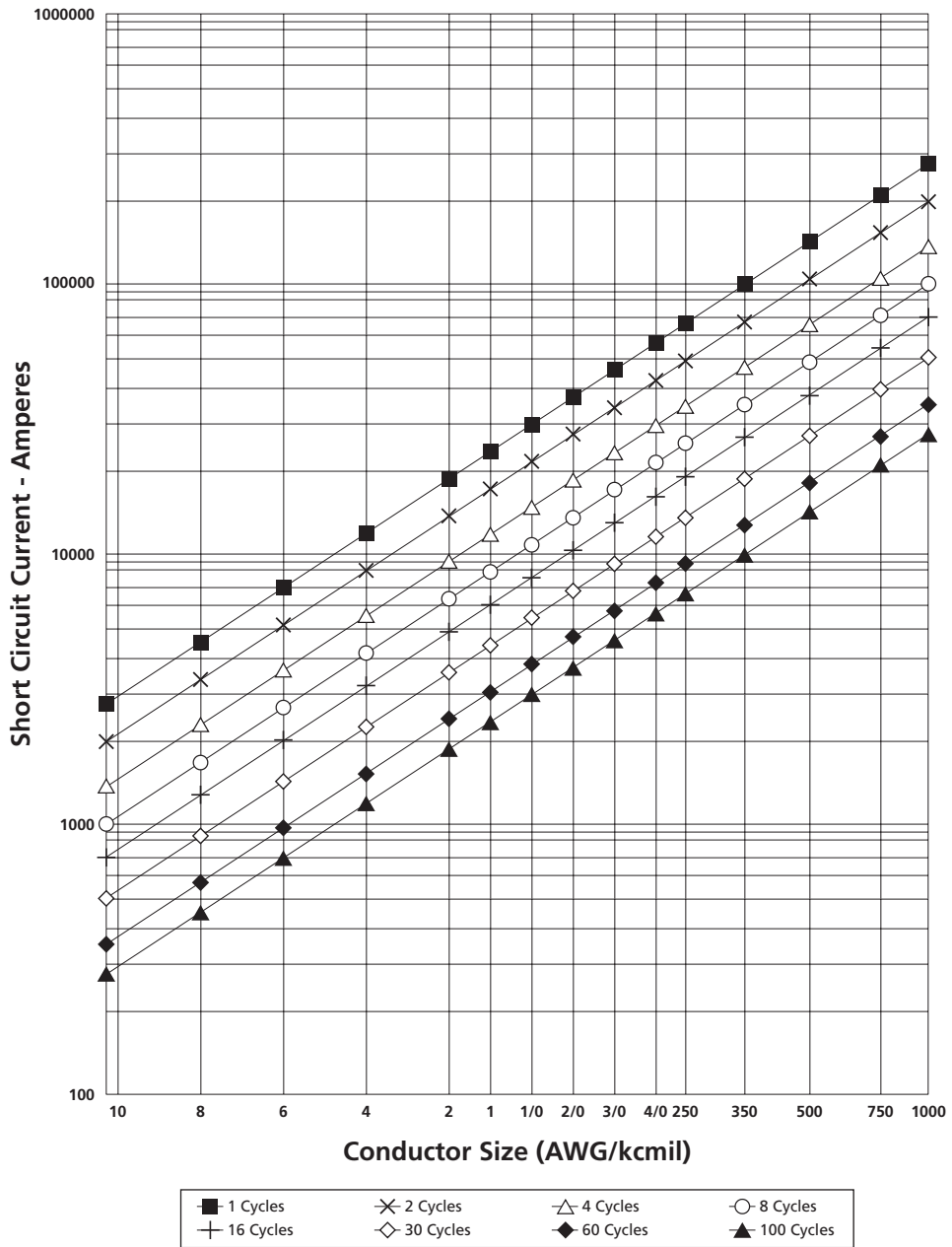

Figure 6-18
Allowable Short Circuit Currents for Thermoplastic Insulated Copper Conductors
Rated 75°C Maximum Continuous Operation

Curves based on the Formula:
$$\left[\frac{I}{A} \right]^2 t = 0.0125 \log \left[\frac{T_2 + 228}{T_1 + 228} \right]$$

Where:

- I = short circuit current - amperes
- A = conductor area - circular mils
- t = time of short circuit - seconds
- T_1 = maximum operating temperature - 75°C
- T_2 = maximum short circuit temperature - 250°C

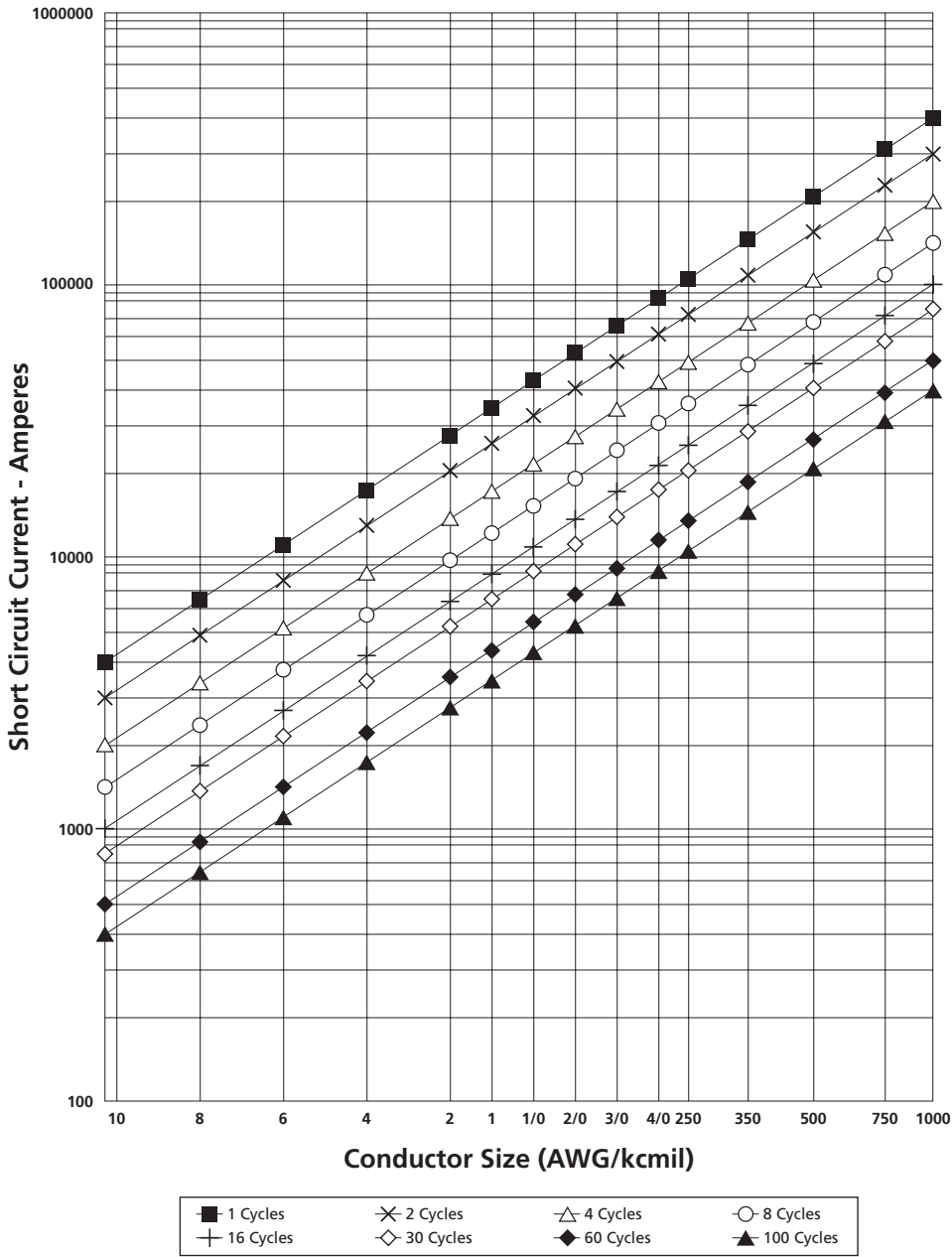

Figure 6-15
Allowable Short Circuit Currents for Thermoplastic Insulated Copper Conductors
Rated 75°C Maximum Continuous Operation

Curves based on the Formula:
$$\left[\frac{I}{A} \right]^2 t = 0.0297 \log \left[\frac{T_2 + 234}{T_1 + 234} \right]$$

Where:

- I = short circuit current - amperes
- A = conductor area - circular mils
- t = time of short circuit - seconds
- T_1 = maximum operating temperature - 75°C
- T_2 = maximum short circuit temperature - 150°C

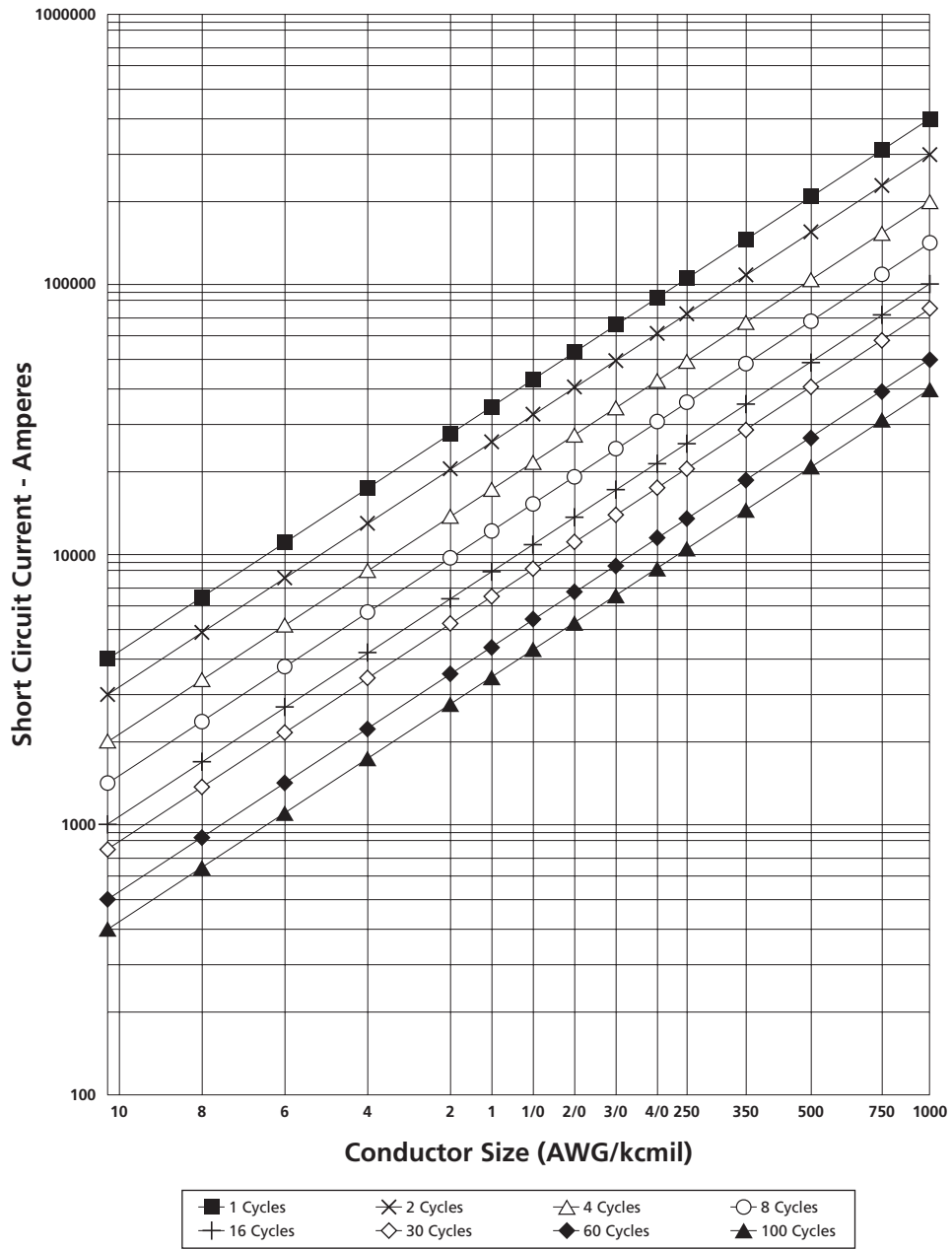

Figure 6-15
Allowable Short Circuit Currents for Thermoplastic Insulated Copper Conductors
Rated 75°C Maximum Continuous Operation

Curves based on the Formula:
$$\left[\frac{I}{A} \right]^2 t = 0.0297 \log \left[\frac{T_2 + 234}{T_1 + 234} \right]$$

Where:

- I = short circuit current - amperes
- A = conductor area - circular mils
- t = time of short circuit - seconds
- T_1 = maximum operating temperature - 75°C
- T_2 = maximum short circuit temperature - 150°C

Metallic Shield Formula

The same general equation (6-32) may be applied to copper metallic shields. For this equation to be valid, the shield temperature must be allowed to return to or below the maximum rated shield temperature (T_1) before another short circuit is encountered. However, the determination of the area (A) of the shield is more involved than for a conductor.

$$I_{SC} = \frac{AF_s}{\sqrt{t}} \quad \text{amps} \quad (6-34)$$

where: F_s = shield short circuit factor from Table 6-2

TABLE 6-2

SHIELD SHORT CIRCUIT FACTORS F_s				
Insulation	Jacket	T_1	T_2	F_s (Copper)
Thermoset (XLPE, EPR)	Thermoplastic (PVC, PE, LSZH, CPE)	85°C	200°C	0.0630
	Thermoset (Hypalon)		350°C	0.0890
Thermoplastic (PVC, PE)	Thermoplastic (PVC, PE, LSZH, CPE)	70°C	200°C	0.0678

NOTES: (A) T_1 is the shield temperature resulting from the maximum conductor operating temperature.
 (B) T_2 is the maximum short circuit shield temperature.
 (C) T_1 and T_2 are from ICEA P-45-482.³
 (D) Calculations can be made for any value of T_1 and T_2 by using equation (6-32).

Equations for Calculation of Shield Areas

The equations for calculating the area of the shield are taken from ICEA.³ For overlapped tapes, ICEA used the concept of effective tape shield area to compensate for the contact resistance between the tape laps that can increase the shield resistance. While in service, the contact resistance will likely increase as the cable ages and is exposed to heat and moisture. ICEA states that under these conditions the contact resistance may approach infinity, where (6-35) could apply.

Helically Applied Tape Shield

Tape Overlapped

$$A = 4bd_m \sqrt{\frac{100}{2(100-L)}} \quad \text{cmils} \quad (6-35)$$

Tape Not Overlapped

$$A = 1.27wb \quad \text{cmils} \quad (6-36)$$

Tubular Shields

$$A = 4bd_m \quad \text{cmils} \quad (6-37)$$

Wire Wrap (Concentric) or Braided Shields

$$A = Nd_s^2 \quad \text{cmils} \quad (6-38)$$

Longitudinally Applied Corrugated Tape

$$A = 1.27[\Pi(D_C + 50) + B]b \quad \text{cmils} \quad (6-39)$$

³ ICEA P-45-482, "Short Circuit Characteristics of Metallic Shields and Sheaths on Insulated Cable" – Fourth Edition, 1999.

where: A = effective cross-sectional area of metallic shield in cmils
 b = tape or tube thickness in mils
 D_c = diameter of core over semiconducting insulation shield in mils
 L = overlap of tape in percent
 d_m = mean diameter of shield in mils
 N = number of wires
 d_s = diameter of wire in mils
 B = tape overlap in mils
 w = width of tape in mils

Typical Calculation

A given circuit has protection devices that are guaranteed to operate within 1 second (60 Hz). What are the maximum conductor and shield short circuit currents when using an EPR insulated 500 kcmil copper cable that has a semiconducting insulation shield diameter of 1.305 inches, with a 5 mil, 1.5 inches wide, 1/4 (25%) overlap copper tape shield and a PVC jacket? The continuous operating temperature of the cable is 105°C.

Conductor Short Circuit Current

Using equation (6-34):

$$I_{SC} = \frac{AF_c}{\sqrt{t}} \text{ amps}$$

$$F_c = 0.0678 \text{ from Table 6-1}$$

$$I_{SC} = \frac{(500,000) \cdot (0.0678)}{\sqrt{1}} \text{ amps}$$

$$I_{SC} = 33,900 \text{ amps}$$

Shield Short Circuit Current

Using equation (6-35):

$$A = 4bd_m \sqrt{\frac{100}{2(100-L)}} \text{ cmils}$$

$$A = (4) \cdot (5) \cdot (1305 + 5) \cdot \sqrt{\frac{100}{2(100-25)}} \text{ cmils}$$

$$A = 21,392 \text{ cmils}$$

Using equation (6-34):

$$I_{SC} = \frac{AF_s}{\sqrt{t}}$$

$$F_s = 0.0630 \text{ from Table 6-2}$$

$$I_{SC} = \frac{(21,392) \cdot (0.0630)}{\sqrt{1}}$$

$$I_{SC} = 1,348 \text{ amps}$$

SHIELD VOLTAGES, CURRENTS, AND LOSSES FOR SINGLE CONDUCTOR CABLES

Shields that are grounded at multiple points have circulating currents induced by the currents of the underlying power conductors. The I²R heating losses produced by the circulating currents have an adverse impact upon the cable ampacity. Table 6-3 provides tabulation of formulas for various arrangements of single conductor cables.

Multiple-Point Grounded Shields

The calculation of shield resistance (R_s) and mutual reactance (X_M) used in Table 6-3 can be facilitated by the following equations.⁴

Shield Resistance

$$R_s = \frac{\rho}{4d_s t} \mu\Omega / \text{foot} \quad (6-40)$$

where: R = Apparent resistivity of shield in ohms-circular mils per foot at operating temperature (assumed at 50°C).

Allowance is included for tapes or wire. Typical values of ρ (rho) are presented in Table 6-4.

d_s = mean diameter of shield in inches

t = thickness of metal tapes used for shielding in inches

Mutual Reactance

$$X_M = 2\pi f (0.1404 \log_{10} \frac{2S}{d_s}) \mu\Omega / \text{ft} \quad (6-41)$$

$$a = 2\pi f (0.1404 \log_{10} 2) \mu\Omega / \text{ft} \quad (6-42)$$

$$b = 2\pi f (0.1404 \log_{10} 5) \mu\Omega / \text{ft} \quad (6-43)$$

where: X_M = mutual inductance of shield and conductor in micro-ohms/foot

a, b = correction factors for mutual inductance for various cable arrangements found in Table 6-3. (The correction factors for 60 Hz are $a = 15.93$ and $b = 36.99 \mu\Omega/\text{foot}$)

Ω = micro-ohm = 10^{-6} ohms

R_s = resistance of shield in micro-ohms/foot

t = thickness of metal tapes used for shielding in inches

f = frequency in hertz

S = spacing between center of cables in inches

d_s = mean diameter of shield in inches

The above equations and the equations included in Table 6-3 are only valid for cable circuits having balanced current loadings.

For an arrangement of three single conductors in the same conduit, use arrangement II of Table 6-3.

⁴ 1957 EEI UGSRB. ANSI/IEEE Standard 525-1992, "IEEE Guide for the Design and Installation of Cable Systems in Substations."

TABLE 6-3
FORMULAS FOR CALCULATING INDUCED SHIELD VOLTAGES AND SHIELD LOSSES FOR SINGLE CONDUCTOR CABLES

Cable Arrangement Diagram	I One Phase	II Equilateral	III Rectangular	IV Flat	V Two Circuit	VI Two Circuit
Induced Shield Voltage — Shields Open Circuited (multiply by 10 ⁻⁶ to obtain V/ft)						
Cable - A } Cable - C }	$I X_M$	$I X_M$	$\frac{1}{2} \sqrt{3Y^2 + (X_M - \frac{a}{2})^2}$	$\frac{1}{2} \sqrt{3Y^2 + (X_M - a)^2}$	$\frac{1}{2} \sqrt{3Y^2 + (X_M - \frac{b}{2})^2}$	$\frac{1}{2} \sqrt{3Y^2 + (X_M - \frac{b}{2})^2}$
Cable - B	$I X_M$	$I X_M$	$I X_M$	$I X_M$	$I (X_M + \frac{a}{2})$	$I (X_M + \frac{a}{2})$
Shield Loss — Shields Solidly Bonded (multiply by 10 ⁻⁶ to obtain W/ft)						
Cable - A } Cable - C }	$I^2 R_S \frac{X_M^2}{R_S^2 + X_M^2}$	$I^2 R_S \frac{X_M^2}{R_S^2 + X_M^2}$	$I^2 R_S \left[\frac{(P^2 + 3Q^2) + 2\sqrt{3}(P-Q) + 4}{4(P^2 + 1)(Q^2 + 1)} \right]$			
Cable - B	$I^2 R_S \frac{X_M^2}{R_S^2 + X_M^2}$	$I^2 R_S \frac{X_M^2}{R_S^2 + X_M^2}$	$I^2 R_S \left[\frac{1}{Q^2 + 1} \right]$			
Total Loss	$2I^2 R_S \frac{X_M^2}{R_S^2 + X_M^2}$	$3I^2 R_S \frac{X_M^2}{R_S^2 + X_M^2}$	$3I^2 R_S \left[\frac{P^2 + Q^2 + 2}{2(P^2 + 1)(Q^2 + 1)} \right]$			
	$P = \frac{R_2}{Y}$ $Q = \frac{R_2}{Z}$	$Y =$ $Z =$	$X_M + \frac{a}{2}$ $X_M - \frac{a}{6}$	$X_M + a$ $X_M - \frac{a}{3}$	$X_M + a + \frac{b}{2}$ $X_M + \frac{a}{3} - \frac{b}{6}$	$X_M + a - \frac{b}{2}$ $X_M + \frac{a}{3} - \frac{b}{6}$

NOTES:
 (a) I = Conductor current (amperes)
 (b) Reprinted from IEEE Standard 525.

TABLE 6-4

APPARENT SHIELD RESISTIVITIES FOR USE WITH EQUATION (6-40)	
Shield or Sheath	ohm-cmil/foot
Lapped, helical, copper tape	30
Bare copper wires	10.6
Aluminum interlocked armor	28
Galvanized steel interlocked armor	70
5052 aluminum alloy	30

Single-Point Grounded Shields

The shield-to-ground voltage will increase along the length of the cable for shields grounded at a single point. The induced shield voltages can be calculated using the formulas given in Table 6-3.

The recommendation for cable lengths that would limit a single-point grounded shield potential to 25 volts is given in IEEE Standard 525.⁵ This data is given in Table 6-5 of this manual. Because the voltage increases in linear proportions to length, cable lengths for other shield potentials can be easily extrapolated from the values given in Table 6-5. Induced shield voltages are also dependent upon cable spacing and geometry. If better precision is desired, then separate calculations should be conducted as shown in Table 6-3.

⁵ ANSI/IEEE Standard 525-1992, "IEEE Guide for the Design and Installation of Cable Systems in Substations."

TABLE 6-5

TYPICAL LENGTHS FOR CABLES WITH SHIELDS GROUNDED AT ONE POINT TO LIMIT SHIELD VOLTAGE TO 25V		
Size Conductor	One Cable Per Duct (ft)	Three Cables Per Duct (ft)
1/0 AWG	1250	4500
2/0 AWG	1110	3970
4/0 AWG	865	3000
250 kcmil	815	2730
350 kcmil	710	2260
400 kcmil	655	2100
500 kcmil	580	1870
750 kcmil	510	1500
1000 kcmil	450	-
2000 kcmil	340	-

Reduced Concentric Neutral Shield Wires

Information on shield resistance calculations and the effect of reduced concentric neutral wires is presented in ICEA.⁶ This information is presented in addition to ampacities and shield losses for single conductor concentric neutral cables. Shield resistance data for 1/3 to 1/36 reduced neutrals is given in Table 6-6. The “fractional” neutrals refer to the approximate ratio of the shield’s resistance to the conductor’s resistance.

TABLE 6-6

CONDUCTOR AND SHIELD RESISTANCE MICROHMS PER FOOT AND 25°C							
Conductor Size, AWG or kcmil	dc Resistance of Conductor	Equivalent Metallic Shield Resistance for 15 kV Through 35 kV					
		1/3	1/6	1/12	1/18	1/24	1/36
STRANDED COPPER CONDUCTORS							
4/0	51.0	153.0	306.0	612.0	918.0	-	-
350	30.8	92.4	184.8	369.6	554.4	-	-
500	21.6	64.8	129.6	259.2	388.8	-	-
750	14.4	43.2	86.4	172.8	259.2	-	-
1000	10.8	-	64.8	129.6	-	259.2	388.8
STRANDED ALUMINUM CONDUCTORS							
4/0	83.6	250.8	501.6	1003.0	1504.8	-	-
350	50.5	151.5	303.0	606.0	909.0	-	-
500	35.4	106.2	212.4	424.8	637.2	-	-
750	23.6	70.8	141.6	283.2	424.8	-	-
1000	17.7	-	106.2	212.4	-	424.8	637.2

⁶ ICEA P-53-426/NEMA WC 50-1976. “Ampacities, Including Effect of Shield Losses for Single-Conductor Solid-Dielectric Power Cable 15kV through 69kV (Copper and Aluminum Conductors). Second Edition, Revised 1999.”

AMPACITY

The variables involved when determining the ampacity of a cable may include:

- Conductor size and material
- Insulation type and thickness
- Shield type and thickness
- Armor type and thickness
- Sheath type and thickness
- Maximum conductor temperature rating
- Number of cables, ducts, conduits, etc.
- AC or dc voltage, frequency of ac voltage
- **Ambient conditions:**
 - Temperature of surrounding environment
 - Exchange rate of air
 - Air pressure and humidity
 - Proximity of heat sources
 - Thermal resistivity of earth*

Any method used to calculate ampacities contains assumptions or procedures that might be challenged. Two approaches are predominantly used: (1) Values from the National Electrical Code (NEC), which are used when compliance with the NEC is required; (2) Values and extrapolations from IEEE Standard 835, which are typically used by the electric utility industry.⁷

NOTE: Guidance provided in the NEC, IEEE, and by the cable manufacturer must be consulted to ensure proper application and use of this information.

Formula

Basic Equations

The heat generated (H_C) by the flow of conductor current is:

$$H_C = NI^2 R_{ac} \quad \text{watts} \quad (6-44)$$

where: N = number of loaded conductors

I = conductor current in amps

R_{ac} = ac resistance of conductor at the conductor operating temperature in ohms

(See Chapter 2 for more on ac resistance.)

This formula correctly assumes that, for modern cables rated 35kV or less, the dielectric losses are very small when compared to the conductor losses and therefore can be ignored.

A thermal resistance of 1 ohm is defined as the path through which a heat flow of 1 watt produces a temperature difference of 1°C. A thermal resistance "circuit" can be drawn that is analogous to an electrical circuit with series resistors, as shown in Figure 6-19.

*The determination of the thermal resistivity of earth is complex. It varies with type of soil, depth of burial, moisture content, and density. In IEEE Standard 835 rho (ρ) is used to express this parameter in units of thermal ohms per cm or °C – cm/watt.⁷ IEEE Standard 5-135 uses a rho equal to 90 as a nominal value and includes tables for rho equal to 60 and 120 thermal ohms per cm. Values ranging from 60 to 300 are not usual. A lower thermal resistivity results in an increased ampacity.

⁷ IEEE 835/ICEA P-46-426, "IEEE-ICEA Power Cable Ampacities, Copper Conductors, Aluminum Conductors. Revised 2000."

The thermal circuit for a single conductor shielded cable suspended in air may be represented by:

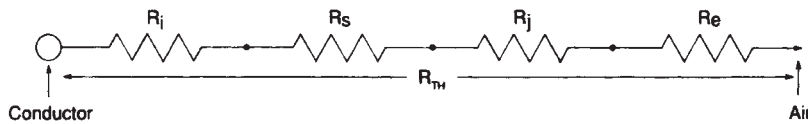

Figure 6-19

$$R_{TH} = R_i + R_s + R_j + R_e \text{ thermal ohm/foot}$$

where: R_{TH} = thermal resistance to air

R_i = thermal resistance of insulation

R_s = thermal resistance of shield

R_j = thermal resistance of jacket

R_e = thermal resistance of environment

or:

$$R_{TH} = \frac{\Delta T}{H_c} = \frac{(T_c - T_A)}{NI^2 R_{ac}} \quad (6-45)$$

solving for I:

$$I = \sqrt{\frac{T_c - T_A}{NR_{ac} R_{TH}}} \text{ amps} \quad (6-46)$$

where: T_c = conductor operating temperature in °C

T_A = ambient temperature in °C

Note that this calculated current should lead to an equilibrium condition so that T_c will not exceed the maximum temperature rating of the cable.

Adjustment for Other Temperature

It is often necessary to determine the ampacity at conditions other than those specified in published tables. Any value of ampacity may be adjusted for a change in one or one more basic parameters by using the following equations:

Copper Conductors

$$I' = I \sqrt{\frac{T'_C - T'_A}{T_C - T_A} \cdot \frac{234 + T'_C}{234 + T_C}} \text{ amps} \quad (6-47)$$

Aluminum Conductors

$$I' = I \sqrt{\frac{T'_C - T'_A}{T_C - T_A} \cdot \frac{228 + T'_C}{228 + T_C}} \text{ amps} \quad (6-48)$$

Where the primed (') values are the revised parameters.

Sample Calculation

A 90°C rated copper cable has a published ampacity of 500 amps under a given set of conditions that include an ambient temperature (T_A) of 40°C. Find the ampacity at a conductor temperature of 80°C and ambient temperature of 50°C.

Using (6-47):

$$I' = I \sqrt{\frac{T'_C - T'_A}{T_C - T_A}} \cdot \frac{234 + T_C}{234 + T'_C} \text{ amps}$$

$$I' = 500 \sqrt{\frac{80 - 50}{90 - 40}} \cdot \frac{234 + 90}{234 + 80} \text{ amps}$$

$$I' = (500) \cdot (0.787) = 393 \text{ amps}$$

Adjustment for Emergency Overloads

The NEC does not recognize overload operation of cable conductors.

ICEA recommendations for emergency overload conditions of the cable vary according to the cable rating. For 0 – 2kV cables, operation at the emergency overload temperature shall not exceed 100 hours in any twelve consecutive months nor more than 500 hours during the lifetime of the cable. For 5kV – 35kV cables, ICEA states operation at the emergency overload temperatures shall not exceed 1500 hours cumulative during the lifetime of the cable. Lower temperatures for emergency overload conditions may be required because of the type of material used in the cable joints and terminations, or because of cable environmental conditions.

Equations (6-47) and (6-48) can be developed into uprating factors for emergency operating temperatures. These uprating factors are presented in Table 6-7.

TABLE 6-7

EMERGENCY OVERLOAD UPRATING FACTORS FOR COPPER AND ALUMINUM CONDUCTORS							
Insulation Type	Voltage Class (kV)	Conductor Operating Temp. (°C)	Conductor Overload Temp. (°C)	Uprating Factors for Ambient Temperature*			
				20°C	30°C	40°C	50°C
Polyethylene (thermoplastic)	35	75	95	1.13	1.16	1.21	1.30
Polyethylene (cross-linked)	35	90	130	1.18	1.22	1.27	1.33
EPR rubber	35	90	130	1.18	1.22	1.27	1.33
Polyethylene (cross-linked), EPR	35	105	140	1.13	1.15	1.18	1.22
Chlorosulfonated polyethylene	0.6	75	95	1.13	1.16	1.21	1.30
Polyvinyl chloride	0.6	60	85	1.22	1.30	1.44	1.80
Polyvinyl chloride	0.6	75	95	1.13	1.16	1.21	1.30

*Ambient temperature of given ampacity.

Adjustments for Other Frequencies

A derating (F_f) for frequencies other than 60 Hz may be determined using the ac/dc ratio (R/R_0) as presented in Chapter 2.

$$I' = I \bullet F_f \text{ amps} \quad (6-49)$$

where: (R/R_0) = ac/dc ratio for 60 Hz

$(R/R_0)'$ = ac/dc ratio for new frequency

Revised ampacity:

$$F_f = \sqrt{\frac{(R/R_0)}{(R/R_0)'}} \quad (6-50)$$

Ampacity Tables

Ampacity tables from the 2005 NEC® are provided with a selection matrix to help choose the correct table based on installation method and cable type.

1 THROUGH 2,000 VOLT COPPER AND ALUMINUM CONDUCTORS						
Installation	Single Conductor		Three Conductor		Three-Conductor Cable	
	Table	NEC Table	Table	NEC Table	Table	NEC Table
Raceway	6-8	310.16	6-8	310.16	6-8	310.16
Direct Burial	6-9	B.310.10	6-12	B.310.9	6-15	B.310.8
Underground Duct	6-10	B.310.5	6-13	B.310.7	6-16	B.310.6
Air	6-11	310.17	6-14	310.20	6-17	B.310.3
Conduit in Air	6-8	310.16	6-8	310.16	6-18	B.310.1
Cable Tray:						
Uncovered	6-11 ¹	310.17 ¹	6-11 ¹	310.17 ¹	6-8	310.16
Covered	6-11 ²	310.17 ²	6-11 ²	310.17 ²	95% x 6-8	95%x310.16
Spaced [†]	6-11	310.17	6-14	310.20	6-17	B.310.3

†Ladder-type tray with maintained spacing between conductors.
 Tables with a "B" prefix should be used only under the supervision of a qualified engineer.
 1: AWG 1/0 through 500 kcmil, 65% x Table 6-11 (NEC Table 310.17);
 600 kcmil and over 75% x Table 6-11 (NEC Table 310.17).
 2: AWG 1/0 through 500 kcmil, 60% x Table 6-11 (NEC Table 310.17);
 600 kcmil and over, 70% x Table 6-11 (NEC Table 310.17).

2,001 THROUGH 35,000 VOLT COPPER CONDUCTORS						
Installation	Single Conductor		Three Conductors		Three-Conductor Cable	
	Table	NEC Table	Table	NEC Table	Table	NEC Table
Direct Burial	6-19	310.81	6-21	310.85	6-25	310.83
Underground Duct			6-22	310.77	6-26	310.79
Air	6-20	310.69	6-23	310.20	6-27	310.71
Conduit in Air			6-24	310.16	6-28	310.75
Cable Tray:						
Uncovered	75% x 6-20	75% x 310.69	75% x 6-20	75% x 310.69	6-28	310.75
Covered	70% x 6-20	70% x 310.69	70% x 6-20	70% x 310.69	95% x 6-28	95%x310.75
Spaced [†]	6-20	310.69	6-23	310.67	6-27	310.71

†Ladder-type tray with maintained spacing between conductors.

NEC REFERENCES FOR USE OF AMPACITY TABLES						
Installation	Single Conductor		Three Conductors		Three-Conductor Cable	
	2,000 V	2,001 – 35,000V	0-2,000 V	2,001-35,000 V	0-2,000 V	2,001-35,000 V
Direct Burial	310.15					
Underground Duct						
Air						
Conduit in Air						
Cable Tray:						
Uncovered	392.11 (B)	392.13 (B)	392.11 (B)	392.13 (B)	392.11 (A)	392.13 (A)
Covered	392.11 (B)	392.13 (B)	392.11 (B)	392.13 (B)	392.11 (A)	392.13 (A)
Spaced	392.11 (B)(3)	392.13 (B)(2)	392.11 (B)(4)	392.13 (B)(3)	392.11 (A)	392.13 (A)

TABLE 6-8 (NEC TABLE 310.16)

ALLOWABLE AMPACITIES OF INSULATED CONDUCTORS RATED 0 THROUGH 2000 VOLTS, 60°C TO 90°C (140°F TO 194°F) NOT MORE THAN THREE CURRENT-CARRYING CONDUCTORS IN RACEWAY, CABLE, OR EARTH (DIRECTLY BURIED), BASED ON AMBIENT TEMPERATURE OF 30°C (86°F)							
Temperature Rating of Conductor (See Table 310.13)							
Size (AWG or kcmil)	60°C (140°F)	75°C (167°F)	90°C (194°F)	60°C (140°F)	75°C (167°F)	90°C (194°F)	Size (AWG or kcmil)
	TYPES TW UF	TYPES RHW THHW THW THWN XHHW USE, ZW	TYPES TBS, SA, SIS, FEP, FEPB, MI, RHH, RHW-2, THHN THHW THW-2 THWN-2 USE-2, XHH, XHHW, XHHW-2, ZW-2	TYPES TW UF	TYPES RHW, THHW THW, THWN, XHHW, USE	TYPES TBS, SA, SIS, THHN, THHW, THW-2, RHH, RHW-2, THWN-2 USE-2, XHH, XHHW, XHHW-2, ZW-2	
	COPPER			ALUMINUM OR COPPER-CLAD ALUMINUM			
18	-	-	14	-	-	-	-
16	-	20	18	-	-	-	-
14*	20	25	25	-	-	-	-
12*	25	35	30	20	20	25	12*
10*	30	-	40	25	30	35	10*
8	40	50	55	30	40	45	8
6	55	65	75	40	50	60	6
4	70	85	95	55	65	75	4
3	85	100	110	65	75	85	3
2	95	115	130	75	90	100	2
1	110	130	150	85	100	115	1
1/0	125	150	170	100	120	135	1/0
2/0	145	175	195	115	135	150	2/0
3/0	165	200	225	130	155	175	3/0
4/0	195	230	260	150	180	205	4/0
250	215	255	290	170	205	230	250
300	240	285	320	190	230	255	300
350	260	310	350	210	250	280	350
400	280	335	380	225	270	305	400
500	320	380	430	260	310	350	500
600	355	420	475	285	340	385	600
700	385	460	520	310	375	420	700
750	400	475	535	320	385	435	750
800	410	490	555	330	395	450	800
900	435	520	585	355	425	480	900
1000	455	545	615	375	445	500	1000
1250	495	590	665	405	485	545	1250
1500	520	625	705	435	520	585	1500
1750	545	650	735	455	545	615	1750
2000	560	665	750	470	560	630	2000
Correction Factor							
Ambient Temp. (°C)	For ambient temperatures other than 30°C (86°F), multiply the allowable Ambient ampacities shown above by the appropriate factor shown below.						Temp. (°F)
21-25	1.08	1.05	1.04	1.08	1.05	1.04	70-77
26-30	1.00	1.00	1.00	1.00	1.00	1.00	78-86
31-35	.91	.94	.96	.91	.94	.96	87-95
36-40	.82	.88	.91	.82	.88	.91	96-104
41-45	.71	.82	.87	.71	.82	.87	105-113
46-50	.58	.75	.82	.58	.75	.82	114-122
51-55	.41	.67	.76	.41	.67	.76	123-131
56-60	-	.58	.71	-	.58	.71	132-140
61-70	-	.33	.58	-	.33	.58	141-158
71-80	-	-	.41	-	-	.41	159-176

*Unless specifically permitted elsewhere in the NEC, the overcurrent protection for conductor types shall not exceed 15 amperes for 14 AWG, 20 amperes for 12 AWG, and 30 amperes for 10 AWG copper; or 15 amperes for 12 AWG and 25 amperes for 10 AWG aluminum and copper-clad aluminum after any correction factors for ambient temperature and number of conductors have been applied.

Reprinted with permission from NFPA 70-2005, the National Electrical Code®, copyright 2005, National Fire Protection Association, Quincy MA 02269. This reprinted material is not the complete and official position of the National Fire Protection Association on the referenced subject which is represented only the standard in its entirety.

TABLE 6-9 (NEC TABLE B.310.10)

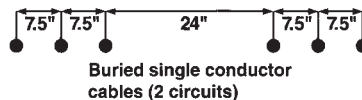
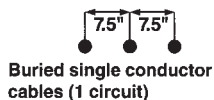

AMPACITIES OF THREE SINGLE INSULATED CONDUCTORS RATED 0 THROUGH 2000 VOLTS, DIRECTLY BURIED IN EARTH BASED ON AMBIENT EARTH TEMPERATURE OF 20°C (68°F) 100 PERCENT LOAD FACTOR, THERMAL RESISTANCE (RHO) OF 90										
Size (AWG or kcmil)	1 Circuit		2 Circuits		1 Circuit		2 Circuits		Size (AWG or kcmil)	
	60°C (140°F)	75°C (167°F)	60°C (140°F)	75°C (167°F)	60°C (140°F)	75°C (167°F)	60°C (140°F)	75°C (167°F)		
	TYPES				TYPES					
	UF	USE	UF	USE	UF	USE	UF	USE		
COPPER					ALUMINUM OR COPPER-CLAD ALUMINUM					
8	84	98	78	92	66	77	61	72	8	
6	107	126	101	118	84	98	78	92	6	
4	139	163	130	152	108	127	101	118	4	
2	178	209	165	194	139	163	129	151	2	
1	201	236	187	219	157	184	146	171	1	
1/0	230	270	212	249	179	210	165	194	1/0	
2/0	261	306	241	283	204	239	188	220	2/0	
3/0	297	348	274	321	232	272	213	250	3/0	
4/0	336	394	309	362	262	307	241	283	4/0	
250	-	429	-	394	-	335	-	308	250	
350	-	516	-	474	-	403	-	370	350	
500	-	626	-	572	-	490	-	448	500	
750	-	767	-	700	-	605	-	552	750	
1000	-	887	-	808	-	706	-	642	1000	
1250	-	979	-	891	-	787	-	716	1250	
1500	-	1063	-	965	-	862	-	783	1500	
1750	-	1133	-	1027	-	930	-	843	1750	
2000	-	1195	-	1082	-	990	-	897	2000	
Correction Factor										
Ambient Temp. (C°)	For ambient temperatures other than 20°C (68°F), multiply the ampacities shown above by the appropriate factor shown below.								Ambient Temp. (F°)	
6-10	1.12	1.09	1.12	1.09	1.12	1.09	1.12	1.09	43-5	
11-15	1.06	1.04	1.06	1.04	1.06	1.04	1.06	1.04	52-59	
16-20	1.00	1.00	1.00	1.00	1.00	1.00	1.00	1.00	61-68	
21-25	0.94	0.95	0.94	0.95	0.94	0.95	0.94	0.95	70-77	
26-30	0.87	0.90	0.87	0.90	0.87	0.90	0.87	0.90	79-86	

Reprinted with permission from NFPA 70-2005, the National Electrical Code®, copyright 2005, National Fire Protection Association, Quincy MA 02269. This reprinted material is not the complete and official position of the National Fire Protection Association on the referenced subject which is represented only the standard in its entirety.

TABLE 6-10 (NEC TABLE B.310.5)

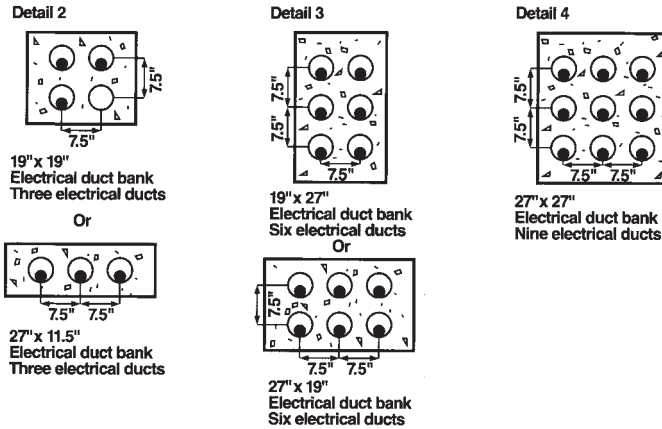

**AMPACITIES OF SINGLE INSULATED CONDUCTORS,
RATED 0 THROUGH 2000 VOLTS IN NONMAGNETIC UNDERGROUND
ELECTRICAL DUCTS (ONE CONDUCTOR PER ELECTRICAL DUCT),
BASED ON AMBIENT EARTH TEMPERATURE OF 20°C (68°F),
CONDUCTOR TEMPERATURE 75°C (167°F), 100% LOAD FACTOR,
THERMAL RESISTANCE (RHO) OF 90.**

Size (AWG or kcmil)	3 Electrical Ducts (Detail 2)	6 Electrical Ducts (Detail 3)	9 Electrical Ducts (Detail 4)	3 Electrical Ducts (Detail 2)	6 Electrical Ducts (Detail 3)	9 Electrical Ducts (Detail 4)	Size (AWG or kcmil)
	TYPES RHW, THHW THW, THWN, XHHW, USE	TYPES RHW, THHW THW, THWN, XHHW, USE	TYPES RHW, THHW THW, THWN, XHHW, USE	TYPES RHW, THHW THW, THWN, XHHW, USE	TYPES RHW, THHW THW, THWN, XHHW, USE	TYPES RHW, THHW THW, THWN, XHHW, USE	
	COPPER			ALUMINUM OR COPPER-CLAD ALUMINUM			
250	344	295	270	269	230	211	250
350	418	355	322	327	277	252	350
500	511	431	387	401	337	305	500
750	640	534	469	505	421	375	750
1000	745	617	533	593	491	432	1000
1250	832	686	581	668	551	478	1250
1500	907	744	619	736	604	517	1500
1750	970	793	651	796	651	550	1750
2000	1027	836	683	850	693	581	2000
Correction Factor							
Ambient Temp. (C°)	For ambient temperatures other than 20°C (68°F), multiply the ampacities shown above by the appropriate factor shown below						Ambient Temp. (C°)
6-10	1.09	1.09	1.09	1.09	1.09	1.09	43-50
11-15	1.04	1.04	1.04	1.04	1.04	1.04	52-59
16-20	1.00	1.00	1.00	1.00	1.00	1.00	61-68
21-25	0.95	0.95	0.95	0.95	0.95	0.95	70-77
26-30	0.90	0.90	0.90	0.90	0.90	0.90	79-86

For Ampacities based on 60 Rho, 120 Rho, and additional load factors, refer to NEC Table B.310.5
 Reprinted with permission from NFPA 70-2005, the National Electrical Code®, copyright 2005, National Fire Protection Association, Quincy MA 02269. This reprinted material is not the complete and official position of the National Fire Protection Association on the referenced subject which is represented only the standard in its entirety.

TABLE 6-11 (NEC TABLE 310.17)

ALLOWABLE AMPACITIES OF SINGLE-INSULATED CONDUCTORS, RATED 0 THROUGH 2000 VOLTS, IN FREE AIR BASED ON AMBIENT TEMPERATURE OF 30°C (86°F)							
Size (AWG or kcmil)	60°C (140°F)	75°C (167°F)	90°C (194°F)	60°C (140°F)	75°C (167°F)	90°C (194°F)	Size (AWG or kcmil)
	TYPES TW UF	TYPES RHW, THHW THW, THWN, XHHW, USE, ZW	TYPES TBS, SA, SIS, FEP, FEPB, MI, RHH, RHW-2, THHN, THHW, THW-2, THWN-2, USE-2, XHH, XHHW, XHHW-2, ZW-2	TYPES TW UF	TYPES RHW, THHW THW, THWN, XHHW, USE	TYPES TBS, SA, SIS, THHN, THHW, THW-2, RHH, RHW-2, THWN-2 USE-2, XHH, XHHW, XHHW-2, ZW-2	
	COPPER			ALUMINUM OR COPPER-CLAD ALUMINUM			
18	-	-	18	-	-	-	-
16	-	-	24	-	-	-	-
14*	25	30	35	-	-	-	-
12*	30	35	40	25	30	35	12*
10*	40	50	55	35	40	40	10*
8	60	70	80	45	55	60	8
6	80	95	105	60	75	80	6
4	105	125	140	80	100	110	4
3	120	145	165	95	115	130	3
2	140	170	190	110	135	150	2
1	165	195	220	130	155	175	1
1/0	195	230	260	150	180	205	1/0
2/0	225	265	300	175	210	235	2/0
3/0	260	310	350	200	240	275	3/0
4/0	300	360	405	235	280	315	4/0
250	340	405	455	265	315	355	250
300	375	445	505	290	350	395	300
350	420	505	570	330	395	445	350
400	455	545	615	355	425	480	400
500	515	620	700	405	485	545	500
600	575	690	780	455	540	615	600
700	630	755	855	500	595	675	700
750	655	785	885	515	620	700	750
800	680	815	920	535	645	725	800
900	730	870	985	580	700	785	900
1000	780	935	1055	625	750	845	1000
1250	890	1065	1200	710	855	960	1250
1500	980	1175	1325	795	950	1075	1500
1750	1070	1280	1445	875	1050	1185	1750
2000	1155	1385	1560	960	1150	1335	2000
Correction Factor							
Ambient Temp. (C°)	For ambient temperatures other than 20°C (68°F), multiply the ampacities shown above by the appropriate factor shown below						Ambient Temp. (C°)
21-25	1.08	1.05	1.04	1.08	1.05	1.04	70-77
26-30	1.00	1.00	1.00	1.00	1.00	1.00	78-86
31-35	0.91	0.94	0.96	0.91	0.94	0.96	87-95
36-40	0.82	0.88	0.91	0.82	0.88	0.91	96-104
41-45	0.71	0.82	0.87	0.71	0.82	0.87	105-113
46-50	0.58	0.75	0.82	0.58	0.75	0.82	114-122
51-55	0.41	0.67	0.76	0.41	0.67	0.76	123-131
56-60	-	0.58	0.71	-	0.58	0.71	132-140
61-70	-	0.33	0.58	-	0.33	0.58	141-158
71-80	-	-	0.41	-	-	0.41	159-176

*Unless specifically permitted elsewhere in the NEC, the overcurrent protection for conductor types shall not exceed 15 amperes for 14 AWG, 20 amperes for 12 AWG, and 30 amperes for 10 AWG copper; or 15 amperes for 12 AWG and 25 amperes for 10 AWG aluminum and copper-clad aluminum after any correction factors for ambient temperature and number of conductors have been applied.

TABLE 6-12 (TABLE B.310.9)

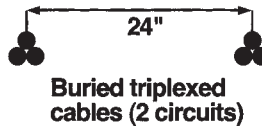

AMPACITIES OF THREE TRIPLEXED SINGLE INSULATED CONDUCTORS RATED 0 THROUGH 2000 VOLTS, DIRECTLY BURIED IN EARTH BASED ON AMBIENT EARTH TEMPERATURE OF 20°C (68°F), 100% LOAD FACTOR, THERMAL RESISTANCE (RHO) OF 90

		1 Circuit		2 Circuit		1 Circuit		2 Circuit			
		60°C (140°F)	75°C (167°F)	60°C (140°F)	75°C (167°F)	60°C (140°F)	75°C (167°F)	60°C (140°F)	75°C (167°F)		
Size (AWG or kcmil)	TYPES				TYPES				Size (AWG or kcmil)		
	UF	USE	UF	USE	UF	USE	UF	USE			
	COPPER				ALUMINUM OR COPPER-CLAD ALUMINUM						
8	72	84	66	77	55	65	51	60	8		
6	91	107	84	99	72	84	66	77	6		
4	119	139	109	128	92	108	85	100	4		
2	153	179	140	164	119	139	109	128	2		
1	173	203	159	186	135	158	124	145	1		
1/0	197	231	181	212	154	180	141	165	1/0		
2/0	223	262	205	240	175	205	159	187	2/0		
3/0	254	298	232	272	199	233	181	212	3/0		
4/0	289	339	263	308	226	265	206	241	4/0		
250	-	370	-	336	-	289	-	263	250		
350	-	445	-	403	-	349	-	316	350		
500	-	536	-	483	-	424	-	382	500		
750	-	654	-	587	-	525	-	471	750		
1000	-	744	-	665	-	608	-	544	1000		
Correction Factor											
Ambient Temp. (C°)	For ambient temperatures other than 20°C (68°F), multiply the ampacities shown above by the appropriate factor shown below								Ambient Temp. (C°)		
6-10	1.12	1.09	1.12	1.09	1.12	1.09	1.12	1.09	43-50		
11-15	1.06	1.04	1.06	1.04	1.06	1.04	1.06	1.04	52-59		
16-20	1.00	1.00	1.00	1.00	1.00	1.00	1.00	1.00	61-68		
21-25	0.94	0.95	0.94	0.95	0.94	0.95	0.94	0.95	70-77		
26-30	0.87	0.90	0.87	0.90	0.87	0.90	0.87	0.90	79-86		

TABLE 6-13 (NEC TABLE B.310.7)

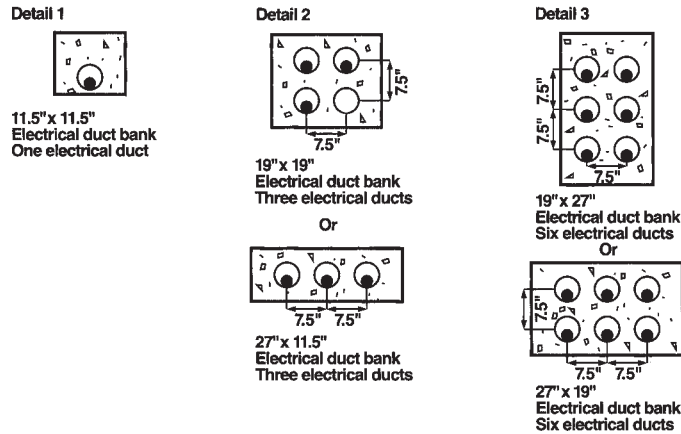

<p align="center">AMPACITIES OF THREE SINGLE INSULATED CONDUCTORS RATED 0 THROUGH 2000 VOLTS, IN UNDERGROUND ELECTRICAL DUCTS (THREE CONDUCTORS PER ELECTRICAL DUCT), BASED ON AMBIENT EARTH TEMPERATURE OF 20°C (68°F), CONDUCTOR TEMPERATURE 75°C (167°F) 100% LOAD FACTOR, THERMAL RESISTANCE (RHO) OF 90</p>							
Size (AWG or kcmil)	1 Electrical Ducts (Detail 1)	3 Electrical Ducts (Detail 2)	6 Electrical Ducts (Detail 3)	2 Electrical Ducts (Detail 1)	3 Electrical Ducts (Detail 2)	6 Electrical Ducts (Detail 3)	Size (AWG or kcmil)
	TYPES RHW, THHW THW, THWN, XHHW, USE	TYPES RHW, THHW THW, THWN, XHHW, USE	TYPES RHW, THHW THW, THWN, XHHW, USE	TYPES RHW, THHW THW, THWN, XHHW, USE	TYPES RHW, THHW THW, THWN, XHHW, USE	TYPES RHW, THHW THW, THWN, XHHW, USE	
	COPPER			ALUMINUM OR COPPER-CLAD ALUMINUM			
8	58	51	44	45	40	34	8
6	77	67	56	60	52	44	6
4	100	86	73	78	67	57	4
3	116	99	83	91	77	65	3
2	132	112	93	103	87	73	2
1	153	128	106	119	100	83	1
1/0	175	146	121	136	114	94	1/0
2/0	200	166	136	156	130	106	2/0
3/0	228	189	154	178	147	121	3/0
4/0	263	215	175	205	168	137	4/0
250	290	236	192	227	185	150	250
300	321	260	210	252	204	165	300
350	351	283	228	276	222	179	350
400	376	302	243	297	238	191	400
500	427	341	273	338	270	216	500
600	468	371	296	373	296	236	600
700	509	402	319	408	321	255	700
750	529	417	330	425	334	265	750
800	544	428	338	439	344	273	800
900	575	450	355	466	365	288	900
1000	605	472	372	494	385	304	1000
Correction Factor							
Ambient Temp. (C°)	For ambient temperatures other than 20°C (68°F), multiply the ampacities shown above by the appropriate factor shown below						Ambient Temp. (C°)
6-10	1.09	1.09	1.09	1.09	1.09	1.09	43-50
11-15	1.04	1.04	1.04	1.04	1.04	1.04	52-59
16-20	1.00	1.00	1.00	1.00	1.00	1.00	61-68
21-25	0.95	0.95	0.95	0.95	0.95	0.95	70-77
26-30	0.90	0.90	0.90	0.90	0.90	0.90	79-86

For Ampacities based on 60 Rho, 120 Rho, and additional load factors, refer to NEC Table B.310.7

TABLE 6-14 (NEC TABLE 310.20)

AMPACITIES OF NOT MORE THAN THREE SINGLE INSULATED CONDUCTORS, RATED THROUGH 2000 VOLTS, SUPPORTED ON A MESSENGER BASED ON AMBIENT AIR TEMPERATURE OF 40°C (104°F)					
Size (AWG or kcmil)	75°C (167°F)	90°C (194°F)	75°C (167°F)	90°C (194°F)	Size (AWG or kcmil)
	TYPES RHW, THHW THW, THWN, XHHW, USE, ZW	TYPES MI, RHH, RHW-2, THHN, THHW, THW-2, THWN-2, USE-2, XHHW-2, ZW-2	TYPES RHW, THHW THW, THWN, XHHW	TYPES THHN, THHW, THW-2, RHH, RHW-2, THWN-2 USE-2, XHH, XHHW, XHHW-2, ZW-2	
COPPER			ALUMINUM OR COPPER-CLAD ALUMINUM		
8	57	66	44	51	8
6	76	89	59	69	6
4	101	117	78	91	4
3	118	138	92	107	3
2	135	158	106	123	2
1	158	185	123	144	1
1/0	183	214	143	167	1/0
2/0	212	247	165	193	2/0
3/0	245	287	192	224	3/0
4/0	287	335	224	262	4/0
250	320	374	251	292	250
300	359	419	282	328	300
350	397	464	312	364	350
400	430	503	339	395	400
500	496	580	392	458	500
600	553	647	440	514	600
700	610	714	488	570	700
750	638	747	512	598	750
800	660	773	532	622	800
900	704	826	572	669	900
1000	748	879	612	716	1000
Correction Factor					
Ambient Temp. (C°)	For ambient temperatures other than 40°C (104°F), multiply the ampacities shown above by the appropriate factor shown below				Ambient Temp. (C°)
21-25	1.20	1.14	1.20	1.14	70-77
26-30	1.13	1.10	1.13	1.10	79-86
31-35	1.07	1.05	1.07	1.05	88-95
36-40	1.00	1.00	1.00	1.00	97-104
41-45	0.93	0.95	0.93	0.95	106-113
46-50	0.85	0.89	0.85	0.89	115-122
51-55	0.76	0.84	0.76	0.84	124-131
56-60	0.65	0.77	0.65	0.77	133-140
61-70	0.38	0.63	0.38	0.63	142-158
71-80	-	0.45	-	0.45	160-176

TABLE 6-15 (NEC TABLE B.310.8)



AMPACITIES OF TWO OR THREE SINGLE INSULATED CONDUCTORS RATED 0 THROUGH 2000 VOLTS, CABLED WITHIN AN OVERALL (TWO-OR-THREE-CONDUCTOR) COVERING, DIRECTLY BURIED IN EARTH, BASED ON AMBIENT EARTH TEMPERATURE OF 20°C (68°F) 100% LOAD FACTOR, THERMAL RESISTANCE (RHO) OF 90

Size (AWG or kcmil)	1 Cable		2 Cables		1 Cable		2 Cables		Size (AWG or kcmil)
	60°C (140°F)	75°C (167°F)	60°C (140°F)	75°C (167°F)	60°C (140°F)	75°C (167°F)	60°C (140°F)	75°C (167°F)	
	TYPES				TYPES				
	UF	RHW, THW, THHW, THWN, XHHW, USE	UF	RHW, THW, THHW, THWN, XHHW, USE	UF	RHW, THW, THHW, THWN, XHHW, USE	UF	RHW, THW, THHW, THWN, XHHW, USE	
COPPER				ALUMINUM OR COPPER-CLAD ALUMINUM					
8	64	75	66	70	51	59	47	55	8
6	85	100	84	95	68	75	60	70	6
4	107	125	109	117	83	97	78	91	4
2	137	161	140	150	107	126	110	117	2
1	155	282	159	170	212	142	113	132	1
1/0	177	208	181	193	138	162	129	151	1/0
2/0	201	236	205	220	157	184	146	171	2/0
3/0	229	269	232	250	179	210	166	195	3/0
4/0	259	304	263	282	203	238	188	220	4/0
250	-	333	-	308	-	261	-	241	250
350	-	401	-	370	-	315	-	290	350
500	-	481	-	442	-	381	-	350	500
750	-	585	-	535	-	473	-	433	750
1000	-	657	-	600	-	545	-	497	1000
Correction Factor									
Ambient Temp. (C°)	For ambient temperatures other than 20°C (68°F), multiply the ampacities shown above by the appropriate factor shown below								Ambient Temp. (C°)
6-10	1.12	1.09	1.12	1.09	1.12	1.09	1.12	1.09	43-50
11-15	1.06	1.04	1.06	1.04	1.06	1.04	1.06	1.04	52-59
16-20	1.00	1.00	1.00	1.00	1.00	1.00	1.00	1.00	61-68
21-25	0.94	0.95	0.94	0.95	0.94	0.95	0.94	0.95	70-77
26-30	0.87	0.90	0.87	0.90	0.87	0.90	0.87	0.90	79-86

For ampacities for UF cable in underground electrical ducts, multiply the ampacities shown in the table by 0.74

TABLE 6-16 (NEC TABLE B.310.6)

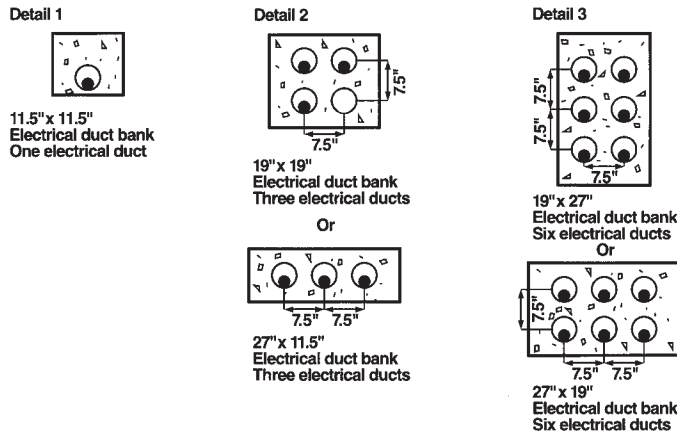

AMPACITIES OF THREE INSULATED CONDUCTORS, RATED 0 THROUGH 2000 VOLTS, WITHIN AN OVERALL COVERING (THREE CONDUCTOR CABLE) IN UNDERGROUND ELECTRICAL DUCTS (ONE CABLE PER ELECTRICAL DUCT), BASED ON AMBIENT EARTH TEMPERATURE OF 20°C (68°F), CONDUCTOR TEMPERATURE 75°C (167°F) 100% LOAD FACTOR, THERMAL RESISTANCE (RHO) OF 90

Size (AWG or kcmil)	3 Electrical Ducts (Detail 2)	6 Electrical Ducts (Detail 3)	9 Electrical Ducts (Detail 4)	3 Electrical Ducts (Detail 2)	6 Electrical Ducts (Detail 3)	9 Electrical Ducts (Detail 4)	Size (AWG or kcmil)
	TYPES RHW, THHW THW, THWN, XHHW, USE	TYPES RHW, THHW THW, THWN, XHHW, USE	TYPES RHW, THHW THW, THWN, XHHW, USE	TYPES RHW, THHW THW, THWN, XHHW, USE	TYPES RHW, THHW THW, THWN, XHHW, USE	TYPES RHW, THHW THW, THWN, XHHW, USE	
	COPPER			ALUMINUM OR COPPER-CLAD ALUMINUM			
8	54	48	42	42	37	32	8
6	71	63	54	55	49	42	6
4	93	81	69	72	63	54	4
2	121	105	89	94	82	70	2
1	140	121	102	109	94	79	1
1/0	160	137	116	125	107	90	1/0
2/0	183	156	131	143	122	102	2/0
3/0	210	178	148	164	139	116	3/0
4/0	240	202	168	187	158	131	4/0
250	265	222	184	207	174	144	250
350	321	267	219	252	209	172	350
500	389	320	261	308	254	207	500
750	478	388	314	386	314	254	750
1000	539	435	351	447	361	291	1000
Correction Factor							
Ambient Temp. (C°)	For ambient temperatures other than 20°C (68°F), multiply the ampacities shown above by the appropriate factor shown below						Ambient Temp. (C°)
6-10	1.09	1.09	1.09	1.09	1.09	1.09	43-50
11-15	1.04	1.04	1.04	1.04	1.04	1.04	52-59
16-20	1.00	1.00	1.00	1.00	1.00	1.00	61-68
21-25	0.95	0.95	0.95	0.95	0.95	0.95	70-77
26-30	0.90	0.90	0.90	0.90	0.90	0.90	79-86

For Ampacities based on 60 Rho, 120 Rho, and additional load factors, refer to NEC Table B.310.6.

TABLE 6-17 (NEC TABLE B.310.3)

AMPACITIES OF MULTICONDUCTOR CABLES WITH NOT MORE THAN THREE INSULATED CONDUCTORS, RATED 0 THROUGH 2000 VOLTS, IN FREE AIR, BASED ON AMBIENT AIR TEMPERATURE OF 40°C (104°F) (FOR TC, MC, MI, UF, AND USE CABLES)

Size (AWG or kcmil)	60°C (140°F)	75°C (167°F)	60°C (140°F)	75°C (167°F)	60°C (140°F)	75°C (167°F)	60°C (140°F)	75°C (167°F)	Size (AWG or kcmil)
	COPPER				ALUMINUM OR COPPER-CLAD ALUMINUM				
8	72	84	66	77	55	65	51	60	8
18	-	-	-	11*	-	-	-	-	18
16	-	-	-	16*	-	-	-	-	16
14	18*	21*	24*	25*	-	-	-	-	14
12	21*	28*	30*	32*	18*	21*	24*	25*	12
10	28*	36*	41*	43*	21*	28*	30*	32*	10
8	39	50	56	59	30	39	44	46	8
6	52	68	75	79	41	53	59	61	6
4	69	89	100	104	54	70	78	81	4
3	81	104	116	121	63	81	91	95	3
2	92	118	132	138	72	92	103	108	2
1	107	138	154	161	84	108	120	126	1
1/0	124	160	178	186	97	125	139	145	1/0
2/0	143	184	206	215	111	144	160	168	2/0
3/0	165	213	238	249	129	166	185	194	3/0
4/0	190	245	274	287	149	192	214	224	4/0
250	212	274	305	320	166	214	239	250	250
300	237	306	341	357	186	240	268	280	300
350	261	337	377	394	205	265	296	309	350
400	281	363	406	425	222	287	317	334	400
500	321	416	465	487	255	330	368	385	500
600	354	459	513	538	284	368	410	429	600
700	387	502	562	589	306	405	462	473	700
750	404	523	586	615	328	424	473	495	750
800	415	539	604	633	339	439	490	513	800
900	438	570	639	670	362	469	514	548	900
1000	461	601	674	707	385	499	558	584	1000

Correction Factor

Ambient Temp. (°C)	For ambient temperatures other than 40°C (104°F), multiply the ampacities shown above by the appropriate factor shown below								Ambient Temp. (°C)
21-25	1.32	1.20	1.15	1.14	1.32	1.20	1.15	1.14	70-77
26-30	1.22	1.13	1.11	1.10	1.22	1.13	1.11	1.10	79-86
31-35	1.12	1.07	1.05	1.05	1.12	1.07	1.05	1.05	88-95
36-40	1.00	1.00	1.00	1.00	1.00	1.00	1.00	1.00	97-104
41-45	0.87	0.93	0.94	0.95	0.87	0.93	0.94	0.95	106-113
46-50	0.71	0.85	0.88	0.89	0.71	0.85	0.88	0.89	115-122
51-55	0.50	0.76	0.82	0.84	0.50	0.76	0.82	0.84	124-131
56-60	-	0.65	0.75	0.77	-	0.65	0.75	0.77	133-140
61-70	-	0.38	0.58	0.63	-	0.38	0.58	0.63	142-158
71-80	-	-	0.33	0.44	-	-	0.33	0.44	160-176

*Unless specifically permitted elsewhere in the NEC, the overcurrent protection for conductor types shall not exceed 15 amperes for 14 AWG, 20 amperes for 12 AWG, and 30 amperes for 10 AWG copper; or 15 amperes for 12 AWG and 25 amperes for 10 AWG aluminum and copper-clad aluminum after any correction factors for ambient temperature and number of conductors have been applied.

TABLE 6-18 (NEC TABLE B.310.1)

**AMPACITIES OF TWO OR THREE INSULATED CONDUCTORS
RATED 0 THROUGH 2000 VOLTS, WITHIN AN OVERALL COVERING
(MULTICONDUCTOR CABLE), IN A RACEWAY IN FREE AIR BASED ON
AMBIENT TEMPERATURE OF 30°C (86°F)**

Size (AWG or kcmil)	60°C (140°F)	75°C (167°F)	90°C (194°F)	60°C (140°F)	75°C (167°F)	90°C (194°F)	Size (AWG or kcmil)
	TYPES TW UF	TYPES RH, RHW, THHW THW, THWN, XHHW, ZW	TYPES RHH, RHW-2, THHN, THHW, THW-2, THWN- 2, USE-2, XHH, XHHW, XHHW- 2, ZW-2	TYPES TW	TYPES RH, RHW, THHW THW, THWN, XHHW	TYPES THHN, THHW, THW-2, RHH, RHW-2, THWN-2 USE-2, XHHW, XHHW-2, ZW-2	
	COPPER			ALUMINUM OR COPPER-CLAD ALUMINUM			
14*	16*	18*	21*	-	-	-	14
12*	20*	24*	27*	16*	18*	21*	12
10*	27*	33*	36*	21*	25*	28*	10
8	36	43	48	28	33	37	8
6	48	58	65	38	45	51	6
4	66	79	89	51	61	69	4
3	76	90	102	59	70	79	3
2	88	105	119	69	83	93	2
1	102	121	137	80	95	106	1
1/0	121	145	163	94	113	127	1/0
2/0	138	166	186	108	129	146	2/0
3/0	158	189	214	124	147	167	3/0
4/0	187	223	253	147	176	197	4/0
250	205	245	276	160	192	217	250
300	234	281	317	185	221	250	300
350	255	305	345	202	242	273	350
400	274	328	371	218	261	295	400
500	315	378	427	254	303	342	500
600	343	413	468	279	335	378	600
700	376	452	514	310	371	420	700
750	387	466	529	321	384	435	750
800	397	497	543	331	397	450	800
900	415	500	570	350	421	477	900
1000	448	542	617	382	460	521	1000
Correction Factor							
Ambient Temp. (C°)	For ambient temperatures other than 20°C (68°F), multiply the ampacities shown above by the appropriate factor shown below						Ambient Temp. (C°)
21-25	1.08	1.05	1.04	1.08	1.05	1.04	70-77
26-30	1.00	1.00	1.00	1.00	1.00	1.00	78-86
31-35	0.91	0.94	0.96	0.91	0.94	0.96	87-95
36-40	0.82	0.88	0.91	0.82	0.88	0.91	96-104
41-45	0.71	0.82	0.87	0.71	0.82	0.87	105-113
46-50	0.58	0.75	0.82	0.58	0.75	0.82	114-122
51-55	0.41	0.67	0.76	0.41	0.67	0.76	123-131
56-60	-	0.58	0.71	-	0.58	0.71	132-140
61-70	-	0.33	0.58	-	0.33	0.58	141-158
71-80	-	-	0.41	-	-	0.41	159-176

*Unless specifically permitted elsewhere in the NEC, the overcurrent protection for conductor types shall not exceed 15 amperes for 14 AWG, 20 amperes for 12 AWG, and 30 amperes for 10 AWG copper; or 15 amperes for 12 AWG and 25 amperes for 10 AWG aluminum and copper-clad aluminum after any correction factors for ambient temperature and number of conductors have been applied.

TABLE 6-19 (NEC TABLE 310.81)

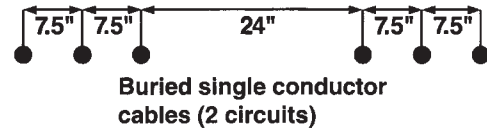
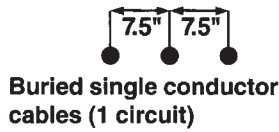

AMPACITIES OF SINGLE INSULATED COPPER CONDUCTORS DIRECTLY BURIED IN EARTH BASED ON AMBIENT EARTH TEMPERATURE OF 20°C (68°F), 100 PERCENT LOAD FACTOR THERMAL RESISTANCE (RHO) OF 90, CONDUCTOR TEMPERATURES OF 90°C (194°F) AND 105°C (221°F)

Conductor Size (AWG or kcmil)	2001-5000 Volts Ampacity		5000-35,000 Volts Ampacity	
	90°C (194°F)	105°C (221°F)	90°C (194°F)	105°C (221°F)
	Type MV-90	Type MV-105	Type MV-90	Type MV-105
One Circuit-3 Conductors				
8	110	115	-	-
6	140	150	130	140
4	180	195	170	180
2	230	250	210	225
1	260	280	240	260
1/0	295	320	275	295
2/0	335	365	310	335
3/0	385	415	355	380
4/0	435	465	405	435
250	470	510	440	475
350	570	615	535	575
500	690	745	650	700
750	845	910	805	865
1000	980	1055	930	1005
Two Circuit-6 Conductors				
8	100	110	-	-
6	130	140	120	130
4	165	180	160	170
2	215	230	195	210
1	240	260	225	240
1/0	275	295	255	275
2/0	310	335	290	315
3/0	355	380	330	355
4/0	400	430	375	405
250	435	470	410	440
350	520	560	495	530
500	630	680	600	645
750	775	835	740	795
1000	890	960	855	920

For SI units: 1 in. = 25.4 mm.

TABLE 6-20 (NEC TABLE 310.69)

AMPACITIES OF INSULATED SINGLE COPPER CONDUCTOR ISOLATED IN AIR BASED ON CONDUCTOR TEMPERATURE OF 90°C (194°F) AND 105°C (221°F) AND AMBIENT AIR TEMPERATURE OF 40°C (104°F)						
Conductor Size (AWG or kcmil)	2001-5000 Volts Ampacity		5001-15,000 Volts Ampacity		15,001-35,000 Volts Ampacity	
	90°C (194°F)	105°C (221°F)	90°C (194°F)	105°C (221°F)	90°C (194°F)	105°C (221°F)
	Type MV-90	Type MV-105	Type MV-90	Type MV-105	Type MV-90	Type MV-105
8	83	93	-	-	-	-
6	110	120	110	125	-	-
4	145	160	150	165	-	-
2	190	215	195	215	-	-
1	225	250	225	250	225	250
1/0	260	290	260	290	260	290
2/0	300	330	300	335	300	330
3/0	345	385	345	385	345	380
4/0	400	445	400	445	395	445
250	445	495	445	495	440	490
350	550	615	550	610	545	605
500	695	775	685	765	680	755
750	900	1000	885	990	870	970
1000	1075	1200	1060	1185	1040	1160
1250	1230	1370	1210	1350	1185	1320
1500	1365	1525	1345	1500	1315	1465
1750	1495	1665	1470	1640	1430	1595
2000	1605	1790	1575	1755	1535	1710

TABLE 6-21 (NEC TABLE 310.85)

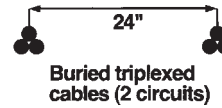

AMPACITIES OF THREE TRIPLEXED SINGLE INSULATED COPPER CONDUCTORS DIRECTLY BURIED IN EARTH, BASED ON AMBIENT EARTH TEMPERATURE OF 20°C (68°F) 100% LOAD FACTOR, THERMAL RESISTANCE (RHO) OF 90 CONDUCTOR TEMPERATURES OF 90°C (194°F) AND 105°C (221°F)

Conductor Size (AWG or kcmil)	2001-5000 Volts Ampacity		5001-35,000 Volts Ampacity	
	90°C (194°F)	105°C (221°F)	90°C (194°F)	105°C (221°F)
	Type MV-90	Type MV-105	Type MV-90	Type MV-105
One Circuit - Three Conductors				
8	90	95	-	-
6	120	130	115	120
4	150	165	150	160
2	195	205	190	205
1	225	240	215	230
1/0	255	270	245	260
2/0	290	310	275	295
3/0	330	360	315	340
4/0	375	405	360	385
250	410	445	390	410
350	490	580	470	505
500	590	635	565	605
750	725	780	685	740
1000	825	885	770	830
Two Circuits - Six Conductors				
8	85	90	-	-
6	110	115	105	115
4	140	150	140	150
2	180	195	175	190
1	205	220	200	215
1/0	235	250	225	240
2/0	265	285	255	275
3/0	300	320	290	315
4/0	340	365	325	350
250	370	395	355	380
350	445	480	425	455
500	535	575	510	545
750	650	700	615	660
1000	740	795	690	745

TABLE 6-22 (NEC TABLE 310.77)

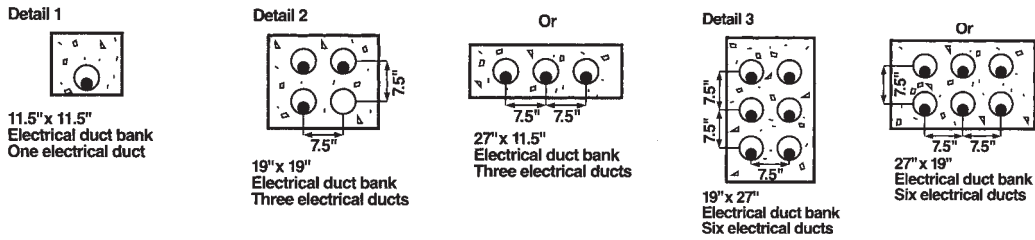

**AMPACITIES OF THREE SINGLE INSULATED COPPER CONDUCTORS
CABLED IN UNDERGROUND ELECTRICAL DUCTS
(THREE CONDUCTORS PER ELECTRICAL DUCT) BASED ON AMBIENT
EARTH TEMPERATURE OF 20°C (68°F), 100% LOAD FACTOR,
THERMAL RESISTANCE (RHO) OF 90, CONDUCTOR TEMPERATURE OF
90°C (194°F) AND 105°C (221°F)**

Conductor Size (AWG or kcmil)	2001-5000 Volts Ampacity		5001-35,000 Volts Ampacity	
	90°C (194°F)	105°C (221°F)	90°C (194°F)	105°C (221°F)
	Type MV-90	Type MV-105	Type MV-90	Type MV-105
One Circuit (Detail 1)				
8	59	64	-	-
6	78	84	88	95
4	100	110	115	125
2	135	145	150	160
1	155	165	170	185
1/0	175	190	195	210
2/0	200	220	220	235
3/0	230	250	250	270
4/0	265	285	285	305
250	290	315	310	335
350	355	380	375	400
500	430	460	450	485
750	530	570	545	585
1000	600	645	615	660
Three Circuits (Detail 2)				
8	53	57	-	-
6	69	74	75	81
4	89	96	97	105
2	115	125	125	135
1	135	145	140	155
1/0	150	165	160	175
2/0	170	185	185	195
3/0	195	210	205	220
4/0	225	240	230	250
250	245	265	255	270
350	295	315	305	325
500	355	380	360	385
750	430	465	430	465
1000	485	520	485	515
Six Circuits (Detail 3)				
8	46	50	-	-
6	60	65	63	68
4	77	83	81	87
2	98	105	105	110
1	110	120	115	125
1/0	125	135	130	145
2/0	145	155	150	160
3/0	165	175	170	180
4/0	185	200	190	200
250	200	220	205	220
350	240	270	245	275
500	290	310	290	305
750	350	375	340	365
1000	390	420	380	405

For SI units: 1 in. = 25.4 mm.

TABLE 6-23 (NEC TABLE 310.67)

AMPACITIES OF INSULATED SINGLE COPPER CONDUCTOR CABLES TRIPLEXED IN AIR BASED ON CONDUCTOR TEMPERATURE OF 90°C (194°F) AND 105°C (221°F) AND AMBIENT AIR TEMPERATURE OF 40°C (104°F)				
Conductor Size (AWG or kcmil)	2001-5000 Volts Ampacity		5001-35,000 Volts Ampacity	
	90°C (194°F)	105°C (221°F)	90°C (194°F)	105°C (221°F)
	Type MV-90	Type MV-105	Type MV-90	Type MV-105
8	65	74	-	-
6	90	99	100	110
4	120	130	130	140
2	160	175	170	195
1	185	205	195	225
1/0	215	240	225	255
2/0	250	275	260	295
3/0	290	320	300	340
4/0	335	375	345	390
250	375	415	380	430
350	465	515	470	525
500	580	645	580	650
750	750	835	730	820
1000	880	980	850	950

TABLE 6-24 (NEC TABLE 310.73)

AMPACITIES OF AN INSULATED TRIPLEXED OR THREE SINGLE- CONDUCTOR COPPER CABLES IN ISOLATED CONDUIT IN AIR BASED ON CONDUCTOR TEMPERATURE OF 90°C (194°F) AND 105°C (221°F) AND AMBIENT AIR TEMPERATURE OF 40°C (104°F)				
Conductor Size (AWG or kcmil)	2001-5000 Volts Ampacity		5001-35,000 Volts Ampacity	
	90°C (194°F)	105°C (221°F)	90°C (194°F)	105°C (221°F)
	Type MV-90	Type MV-105	Type MV-90	Type MV-105
8	55	61	-	-
6	75	84	83	93
4	97	110	110	120
2	130	145	150	165
1	155	175	170	190
1/0	180	200	195	215
2/0	205	225	225	255
3/0	240	270	260	290
4/0	280	305	295	330
250	315	355	330	365
350	385	430	395	440
500	475	530	480	535
750	600	665	585	655
1000	690	770	675	755

TABLE 6-25 (NEC TABLE 310.83)



AMPACITIES OF THREE INSULATED COPPER CONDUCTORS CABLED WITHIN AN OVERALL COVERING (THREE-CONDUCTOR CABLE) DIRECTLY BURIED IN EARTH BASED ON AMBIENT EARTH TEMPERATURE OF 20°C (68°F), 100% LOAD FACTOR, THERMAL RESISTANCE (RHO) OF 90, CONDUCTOR TEMPERATURE OF 90°C (194°F) AND 105°C (221°F)

Conductor Size (AWG or kcmil)	2001-5000 Volts Ampacity		5001-35,000 Volts Ampacity	
	90°C (194°F)	105°C (221°F)	90°C (194°F)	105°C (221°F)
	Type MV-90	Type MV-105	Type MV-90	Type MV-105
One Circuit - (Detail 5)				
8	85	89	-	-
6	105	115	115	120
4	135	150	145	155
2	180	190	185	200
1	200	215	210	225
1/0	230	245	240	255
2/0	260	280	270	290
3/0	295	320	305	330
4/0	335	360	350	375
250	365	395	380	410
350	440	475	460	495
500	530	570	550	590
750	650	700	665	720
1000	730	785	750	810
Two Circuits (Detail 6)				
8	80	84	-	-
6	100	105	105	115
4	130	140	135	145
2	165	180	170	185
1	185	200	195	210
1/0	215	230	220	235
2/0	240	260	250	270
3/0	275	295	280	305
4/0	310	335	320	345
250	340	365	350	375
350	410	440	420	450
500	490	525	500	535
750	595	640	605	650
1000	665	715	675	730

For SI units: 1 in.= 25.4 mm.

TABLE 6-26 (NEC TABLE 310.79)

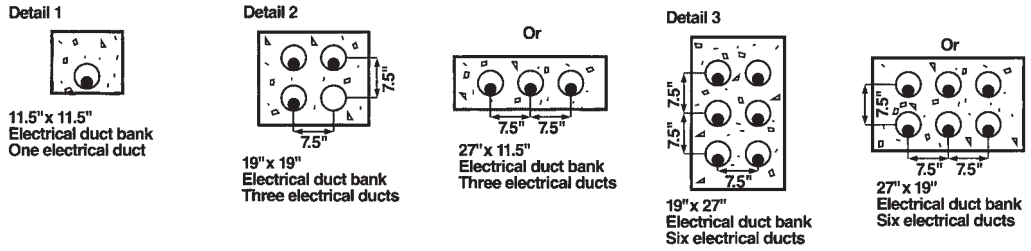

AMPACITIES OF THREE INSULATED COPPER CONDUCTORS CABLED WITHIN AN OVERALL COVERING (THREE-CONDUCTOR CABLE) IN UNDERGROUND ELECTRICAL DUCTS (ONE CABLE PER ELECTRICAL DUCT) BASED ON AMBIENT EARTH TEMPERATURE OF 20°C (68°F), 100% LOAD FACTOR, THERMAL RESISTANCE (RHO) OF 90, CONDUCTOR TEMPERATURE OF 90°C (194°F) AND 105°C (221°F)

Conductor (Size AWG or kcmil)	2001-5000 Volts Ampacity		5001-35,000 Volts Ampacity	
	90°C (194°F)	105°C (221°F)	90°C (194°F)	105°C (221°F)
	Type MV-90	Type MV-105	Type MV-90	Type MV-105
One Circuit (Detail 1)				
8	64	69	-	-
6	85	92	90	97
4	110	120	115	125
2	145	155	155	165
1	170	180	175	185
1/0	195	210	200	215
2/0	220	235	230	245
3/0	250	270	260	275
4/0	290	310	295	315
250	320	345	325	245
350	385	415	390	415
500	470	505	465	500
750	585	630	565	610
1000	670	720	640	690
Three Circuits (Detail 2)				
8	56	60	-	-
6	73	79	77	83
4	95	100	99	105
2	125	130	130	135
1	140	150	145	155
1/0	160	175	165	175
2/0	185	195	185	200
3/0	210	225	210	225
4/0	235	255	240	255
250	260	280	260	280
350	315	335	310	330
500	375	405	370	395
750	460	495	440	475
1000	525	565	495	535
Six Circuits (Detail 3)				
8	48	52	-	-
6	62	67	64	68
4	80	86	82	88
2	105	110	105	115
1	115	125	120	125
1/0	135	145	135	145
2/0	150	160	150	165
3/0	170	185	170	185
4/0	195	210	190	205
250	210	225	210	225
350	250	270	245	265
500	300	325	290	310
750	365	395	350	375
1000	410	445	390	415

For SI units: 1 in.= 25.4 mm.

TABLE 6-27 (NEC TABLE 310.71)

AMPACITIES OF AN INSULATED THREE-CONDUCTOR COPPER CABLE ISOLATED IN AIR BASED ON CONDUCTOR TEMPERATURE OF 90°C (194°F) AND 105°C (221°F) AND AMBIENT AIR TEMPERATURE OF 40°C (104°F)				
Conductor Size (AWG or kcmil)	2001-5000 Volts Ampacity		5001-35,000 Volts Ampacity	
	90°C (194°F)	105°C (221°F)	90°C (194°F)	105°C (221°F)
	Type MV-90	Type MV-105	Type MV-90	Type MV-105
8	59	66	-	-
6	79	88	93	105
4	105	115	120	135
2	140	154	165	185
1	160	180	185	210
1/0	185	205	215	240
2/0	215	240	245	275
3/0	250	280	285	315
4/0	285	320	325	360
250	320	355	360	400
350	395	440	435	490
500	485	545	535	600
750	615	685	670	745
1000	705	790	770	860

TABLE 6-28 (NEC TABLE 310.75)

AMPACITIES OF AN INSULATED THREE-CONDUCTOR COPPER CABLE ISOLATED IN AIR BASED ON CONDUCTOR TEMPERATURE OF 90°C (194°F) AND 105°C (221°F) AND AMBIENT AIR TEMPERATURE OF 40°C (104°F)				
Conductor Size (AWG or kcmil)	2001-5000 Volts Ampacity		5001-35,000 Volts Ampacity	
	90°C (194°F)	105°C (221°F)	90°C (194°F)	105°C (221°F)
	Type MV-90	Type MV-105	Type MV-90	Type MV-105
8	52	58	-	-
6	69	77	83	92
4	91	100	105	120
2	125	135	145	165
1	140	155	165	185
1/0	165	185	195	215
2/0	190	210	220	245
3/0	220	245	250	280
4/0	255	285	290	320
250	280	315	315	350
350	350	390	385	430
500	425	475	470	525
750	525	585	570	635
1000	590	660	650	725

SEQUENCE IMPEDANCE

When a low resistance path occurs between any energized phase and ground or between energized phases and ground or between energized phases, a “short circuit” or “fault” occurs. The cause of the fault may be insulation failure, an arc discharge, or contact between a low resistance object and one or more phases, creating a conducting path to ground and/or between phases. A fault study on a power system can determine the values of system voltages and currents during faulted conditions so that protective devices may be set to detect and minimize the harmful effects of the resulting short circuit current. To determine the fault current, sequence impedance data for cables is used in combination with the sequence impedances for all components, including generators, motors, and transformers. The result of the fault study are used to size, set, and coordinate system protection equipment such as circuit breakers, fuses, instrument transformers, and relays. This section introduces the use of symmetrical components to determine fault currents and provides equations to calculate the sequence impedance of shielded medium voltage cables.

Symmetrical Components

Impedance is commonly taken to be the opposition to the flow of “normal” system currents; sequence impedance is the opposition to the flow of abnormal fault currents. The method of symmetrical components is generally used to quantify fault currents. This method is a powerful tool in the evaluation of unbalanced polyphase circuits. Introduced by C.L. Fortescue⁸ in 1918, this approach shows that an unbalanced system of phasors can be resolved into a system of balanced phasors called symmetrical components. The response of each circuit element depends upon its connections and the component of the current being considered. Equivalent circuits, called “sequence circuits,” reflect the separate responses of the elements to that component of the current. Three such equivalent circuits exist for each element of a three-phase system. These circuits can be organized into three sequence networks. Solving the sequence networks for the fault conditions gives symmetrical current and voltage components. These components can be combined to show the effects of the original unbalanced fault currents on the overall system.

According to Fortescue, three unbalanced phasors of a three-phase system can be resolved into three balanced systems of phasors. The balanced set of components are:

1. **Positive-sequence components** consisting of three phasors equal in magnitude, each with a phase difference of 120 degrees and having the same phase sequence as the original phasors.
2. **Negative-sequence components** consisting of three phasors equal in magnitude, each with a phase difference of 120 degrees and having a phase sequence opposite to the original phasors.
3. **Zero-sequence components** consisting of three phasors equal in magnitude with no difference in phase between them.

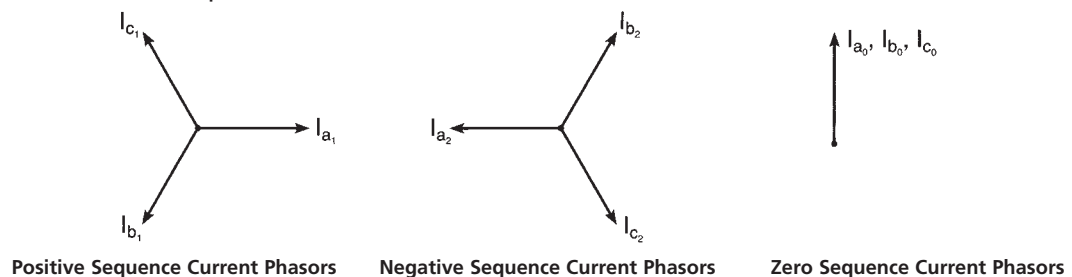

Figure 6-20

⁸ “Method of Symmetrical Coordinates Applied to the Solution of Polyphase Networks,” C.L. Fortescue, 1918, Transactions AIEE, vol. 37, pp. 1027-1140.

The parameters defining the contribution of power cables to the sequence network under analysis are the positive-sequence (Z_1) and negative-sequence (Z_2) impedance, which are equal in value and typically designated as Z_1 , and the zero-sequence impedance (Z_0). The sequence impedance is the sum of the path resistances and the effective impedance resulting from the self-inductance and mutual inductance between phase conductors and between phase conductors and any neutral and/or ground returns. Cable shields and concentric neutrals must be considered because these elements also have path resistance and effective self-inductance and mutual inductance between themselves and the metallic elements of each phase.

The fault currents (I_f), when V equals the phase-to-phase or phase-to-ground voltage, as appropriate, are given by:

$$I_f = \frac{V}{2 \bullet Z_1} \quad \text{phase-to-phase fault current in amps} \quad (6-51)$$

$$I_f = \frac{3 \bullet V}{2 \bullet Z_1 + Z_0} \quad \text{phase-to-ground fault current in amps} \quad (6-52)$$

Effect of Variables

System and equipment complexity and the lack of accurate parameters for many system components make precise calculations of fault currents difficult, but extreme precision is unnecessary. Fault current calculations do not require precise sequence impedance values to provide reasonable accuracy. Many times the same data can be used for several types of cable constructions and installations without having an appreciable effect on overall system sequence impedance values and resulting short circuit currents.

However, the effects of different variables on the final values of sequence impedance are of interest. These effects give an indication of which parameters are more or less important for a given set of conditions. Figures 6-21 through 6-24 are plots of the percentage change in sequence impedance versus selected key variables with other variables held constant. These plots are intended to show trends and are not for quantitative determinations. (Remember that phase-to-phase fault currents are inversely proportional to Z_1 , and phase-to-ground faults are inversely proportional to the sum of two times Z_1 plus Z_0 .)

The typical case used in this analysis is three single 500 kcmil copper conductors, 15kV, 133% insulation level, tape shielded and jacketed cables. In the first three plots, the cables are arranged in a triplexed configuration. In the cable spacing example, triplexed cables are compared to parallel-laid cables with spacing as indicated.

Examination of these plots leads to several general conclusions.

1. In Figure 6-21, the steep slope of the curve suggests that shield resistance is critical when determining Z_0 . Because shield resistance can vary considerably with the type, configuration, and age of the cable, systems designers should pay close attention to these values.
2. On the other hand, Figure 6-22 demonstrates that soil resistivity—which can sometimes be difficult to measure—has little impact on impedance calculations, even with significant divergence from a nominal value.

3. The flat slope and low magnitude of the curves in Figure 6-23 suggests that insulation thickness is also not a significant factor when determining either Z_1 or Z_0 . A practical result of this conclusion would be that engineers can use published sequence impedance values for 100% or 133% insulation levels interchangeably.

4. Figure 6-24 shows a nonlinear relationship between Z_1 , and separation distance of parallel-laid cables. The first increase of a couple of inches in separation causes significant increase in Z_1 , whereas a similar increase from 14 to 16 inches has considerably less impact.

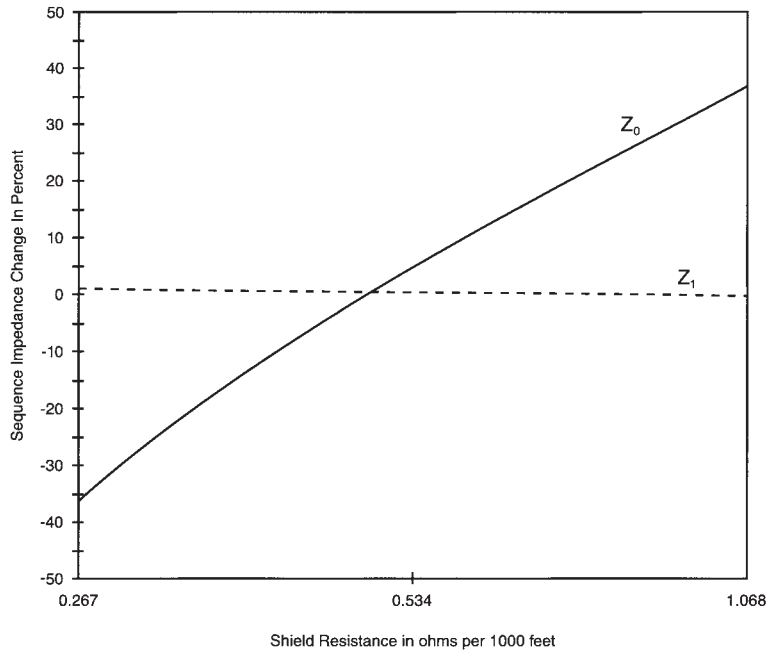

Figure 6-21
Effect of Shield Resistance on Sequence Impedance

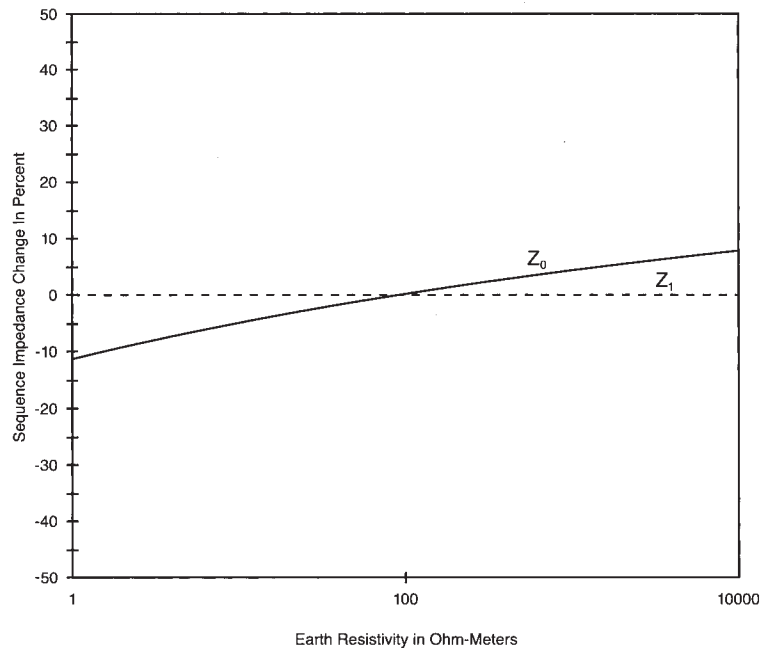

Figure 6-22
Effect of Earth Resistivity on Sequence Impedance

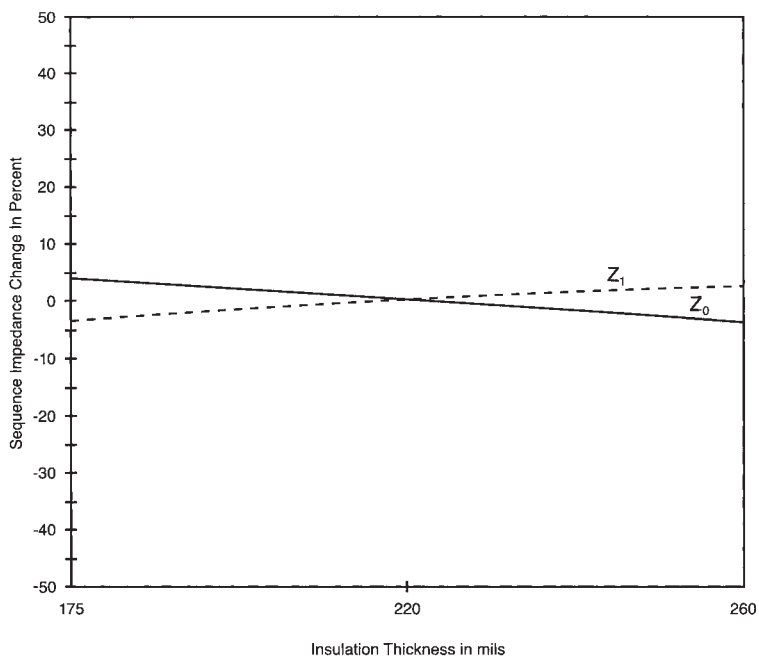

Figure 6-23
Effect of Insulation Thickness on Sequence Impedance

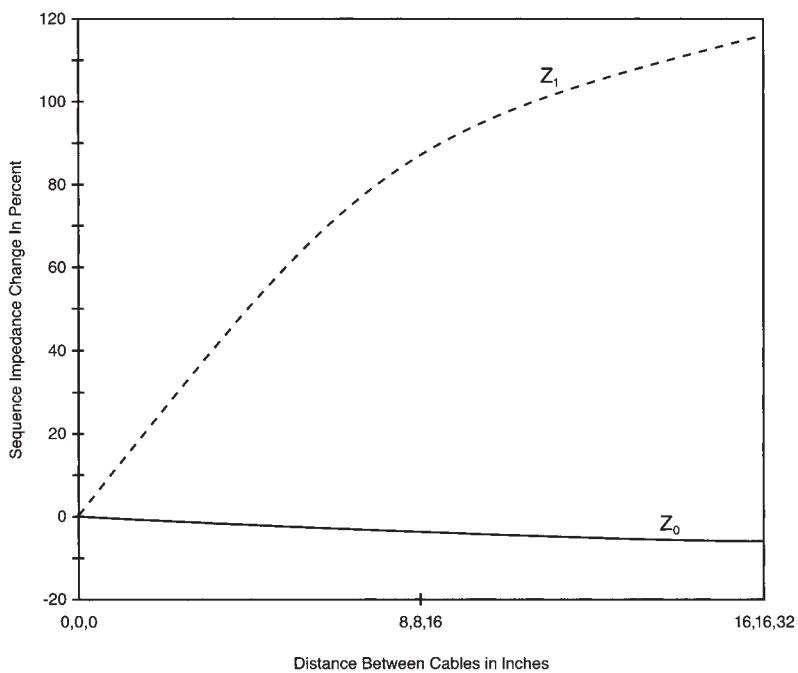

Figure 6-24
Effect of Cable Spacing on Sequence Impedance

SEQUENCE IMPEDANCE EQUATIONS

The following formulas are based on three-phase power systems having a frequency of 60 Hz. The typical case of solidly grounded shields plus an earth return is assumed. For power cables, Z_1 is equal to Z_2 ; therefore only Z_1 needs to be calculated.

Traditionally, the effect of the cable's grounding conductor(s) is not considered in the calculation of sequence impedances. The quantification of the net effect of these factors is beyond the scope of this work.

Tape Shielded Medium Voltage Cables

Three-Phase Positive- and Negative-Sequence (Z_1) And Zero-Sequence (Z_0) Impedances.⁹

$$Z_1 = Z_{aa} - Z_{ab} - \frac{(Z_{as} - Z_{ab})^2}{Z_{ss} - Z_{ab}} \quad \text{ohms / 1000 feet} \quad (6-53)$$

$$Z_0 = Z_{aa} + 2 \cdot Z_{ab} - \frac{(Z_{as} + 2 \cdot Z_{ab})^2}{Z_{ss} + 2 \cdot Z_{ab}} \quad \text{ohms / 1000 feet} \quad (6-54)$$

where: Z_{aa} = self-impedance of each phase conductor with earth return in ohms per 1000 feet

Z_{ab} = mutual impedance between phase conductors with earth return in ohms per 1000 feet

Z_{as} = mutual impedance between each phase conductor and its tape shield in ohms per 1000 feet

Z_{ss} = self-impedance of each tape shield with earth return in ohms per 1000 feet.

Self-Impedances

$$Z_{aa} = R_{\phi} + 0.0181 + 0.0529j \cdot \log_{10} \left(\frac{D_e}{GMR_{\phi}} \right) \quad \text{ohms / 1000 feet} \quad (6-55)$$

$$Z_{ss} = R_s + 0.0181 + 0.0529j \cdot \log_{10} \left(\frac{D_e}{GMR_s} \right) \quad \text{ohms / 1000 feet} \quad (6-56)$$

Mutual Impedances:

$$Z_{ab} = 0.0181 + 0.0529j \cdot \log_{10} \left(\frac{D_e}{GMD_{\phi}} \right) \quad \text{ohms / 1000 feet} \quad (6-57)$$

$$Z_{as} = 0.0181 + 0.0529j \cdot \log_{10} \left(\frac{D_e}{GMR_s} \right) \quad \text{ohms / 1000 feet} \quad (6-58)$$

⁹ Underground Transmission Systems Reference Book, 1992 edition, Electrical Power Research Institute.

- where: R_{ϕ} = ac resistance of a phase conductor at the operating temperature in ohms per 1000 feet
 R_s = effective shield resistance in ohms per 1000 feet
 D_e = mean depth of earth return current in inches
 GMR_{ϕ} = geometric mean radius of the phase conductor R in inches
 GMR_s = radius from center of phase conductor to center of shield in inches.
 GMD_{ϕ} = distance between the centers of two phase conductors in inches

Wire Shielded and Concentric Neutral Medium Voltage Cables

Three-Phase Positive- and Negative-Sequence ($Z_{13\phi}$) and Zero-Sequence ($Z_{03\phi}$) Impedances¹⁰

$$Z_{13\phi} = Z_{aa} - Z_{ab} - \frac{Z_{an/p}^2}{Z_{nn/p}} \quad \text{ohms/1000 feet} \quad (6-59)$$

$$Z_{03\phi} = Z_{aa} + 2 \cdot Z_{ab} - \frac{3 \cdot Z_{an/g_{3\phi}}^2}{Z_{nn/g_{3\phi}}} \quad \text{ohms/1000 feet} \quad (6-60)$$

- where: $Z_{13\phi}$ = positive sequence impedance of three-phase concentric neutral circuit in ohms per 1000 feet
 $Z_{03\phi}$ = zero sequence impedance of three-phase concentric neutral circuit in ohms per 1000 feet
 Z_{aa} = self-impedance of each phase conductor with earth return in ohms per 1000 feet
 Z_{ab} = mutual impedance between phase conductors with earth return in ohms per 1000 feet
 $Z_{an/p}$ = positive mutual impedance between phases and concentric neutrals in ohms per 1000 feet
 $Z_{nn/p}$ = positive self-impedance of the concentric neutrals of the three-phase circuit in ohms per 1000 feet
 $Z_{an/g_{3\phi}}$ = mutual impedance between each phase and all concentric neutrals in ohms per 1000 feet
 $Z_{nn/g_{3\phi}}$ = self-impedance of all concentric neutrals with earth return in ohms per 1000 feet

Self-Impedances:

$$Z_{aa} = R_{\phi} + 0.0181 + 0.0377j \cdot \left[4.68 + 0.610 \cdot \ln \left(\frac{1.55 \cdot \sqrt{p}}{GMR_{\phi}} \right) \right] \quad \text{ohms/1000 feet} \quad (6-61)$$

$$Z_{nn/g_{3\phi}} = \frac{R_n}{3} + 0.0181 + 0.0377j \cdot \left[4.68 + 0.610 \cdot \ln(0.129 \cdot \sqrt{p}) \right. \\ \left. + 0.610 \cdot \ln \left(\frac{5.24}{\sqrt[3]{GMD_{\phi}^2}} \right) + 0.610 \cdot \frac{1}{3 \cdot N} \right. \\ \left. \cdot \left[\ln \left(\frac{12}{GMR_n} \right) + (N-1) \cdot \ln \left(\frac{12}{K_n \cdot GMR_s} \right) \right] \right] \quad \text{ohms/1000 feet} \quad (6-62)$$

¹⁰ Electrical Transmission and Distribution System Analysis and Design Programs, Version 3.50, August 1992, EDSA Micro Corporation, Bloomfield Hills, MI.

$$Z_{m/p} = R_n + 0.0377j \cdot 0.610 \cdot \left[\frac{N-1}{N} \cdot \ln \left(\frac{12}{K_n \cdot GMR_s} \right) + \frac{1}{N} \cdot \ln \left(\frac{12}{GMR_n} \right) - \ln \left(\frac{12}{GMD_\phi} \right) \right] \text{ ohms / 1000 feet} \quad (6-63)$$

Mutual Impedances:

$$Z_{ab} = 0.0181 + 0.0377j \cdot \left[4.68 + 0.610 \cdot \ln \left(\frac{1.55 \cdot \sqrt{\rho}}{GMD_\phi} \right) \right] \text{ ohms / 1000 feet} \quad (6-64)$$

$$Z_{an/g_\phi} = 0.0181 + 0.0377j \cdot \left[4.68 + 0.610 \cdot \ln \left[\frac{1.55 \cdot \sqrt{\rho}}{\sqrt[3]{GMR_s \cdot GMD_\phi^2}} \right] \right] \text{ ohms / 1000 feet} \quad (6-65)$$

$$Z_{an/p} = 0.0377j \cdot 0.610 \cdot \left[\ln \left(\frac{12}{GMR_s} \right) - \ln \left(\frac{12}{GMD_\phi} \right) \right] \text{ ohms / 1000 feet} \quad (6-66)$$

where: R_ϕ = ac resistance of a phase conductor at the operating temperature in ohms per 1000 feet

R_n = effective resistance of the concentric neutral (or wire shield) in ohms per 1000 feet

ρ = earth resistivity in ohms-meter

GMR_ϕ = geometric mean radius of the phase conductor in inches

GMR_s = radius from center of phase conductor to center of shield in inches

GMR_n = geometric mean radius of a single neutral strand in inches

GMD_ϕ = distance between the centers of two phase conductors in inches

N = the number of shield or neutral wires

K_n = spacing factor of concentric neutral wires

Single-Phase Laterals

Single-phase lateral circuits require modifications of the three-phase formulas because only phase-to-ground faults are applicable.¹¹ As shown in Formula 6-52, I_f is dependent upon Z_1 and Z_0 . Z_1 and Z_0 are dependent upon Z_{ab} , which is in turn dependent upon the geometric mean distance (GMD_ϕ) between nonexistent phases. This contraction does not present a practical problem because the Z_{ab} terms cancel in the calculation of single-phase fault currents and can therefore be removed from the formula for $Z_{1\phi}$ and $Z_{0\phi}$.

$$Z_{1\phi} = Z_{ad_{1\phi}} \text{ ohms / 1000 feet} \quad (6-67)$$

¹¹ Distribution-System Protection Manual, McGraw-Edison.

$$Z_{01\phi} = Z_{aa1\phi} - \frac{3 \cdot Z_{an/g1\phi}^2}{Z_{nn/g1\phi}} \text{ ohms/1000 feet} \quad (6-68)$$

where: $Z_{11\phi}$ = positive sequence impedance of single-phase lateral concentric neutral circuit in ohms per 1000 feet

$Z_{01\phi}$ = zero sequence impedance of single-phase lateral concentric neutral circuit in ohms per 1000 feet

$Z_{aa1\phi}$ = self-impedance of phase conductor with earth return in ohms per 1000 feet

$Z_{an/g1\phi}$ = mutual impedance of a lateral phase conductor in ohms per 1000 feet

$Z_{nn/g1\phi}$ = self-impedance of a concentric neutral lateral with earth return in ohms per 1000 feet

Self-Impedances:

$$Z_{aa1\phi} = R_{\phi} + 0.0181 + 0.0377j \cdot \left[4.68 + 0.610 \cdot \ln \left(\frac{1.55 \cdot \sqrt{\rho}}{GMR_{\phi}} \right) \right] \text{ ohms/1000 feet} \quad (6-69)$$

$$Z_{nn/g1\phi} = R_n + 0.0181 + \frac{0.0377j}{N} \cdot \left[4.68 + 0.610 \cdot \ln \left(\frac{1.55 \cdot \sqrt{\rho}}{GMR_n} \right) \right. \\ \left. + (N-1) \cdot 4.68 + (N-1) \cdot 0.610 \cdot \ln \left(\frac{1.55 \cdot \sqrt{\rho}}{K_n \cdot GMR_s} \right) \right] \text{ ohms/1000 feet} \quad (6-70)$$

Mutual Impedance:

$$Z_{an/g1\phi} = 0.0181 + 0.0377j \cdot \left[4.68 + 0.610 \cdot \ln \left(\frac{1.55 \cdot \sqrt{\rho}}{GMR_s} \right) \right] \text{ ohms/1000 feet} \quad (6-71)$$

where: R_{ϕ} = ac resistance of a phase conductor at the operating temperature in ohms per 1000 feet

R_n = effective resistance of the concentric neutral (or wire shield) in ohms per 1000 feet

ρ = earth resistivity in ohms-meter

GMR_{ϕ} = geometric mean radius of the phase conductor in inches

GMR_n = geometric mean radius of a single neutral strand in inches

GMR_s = radius from center of phase conductor to center of shield in inches

N = the number of shield or neutral wires

K_n = spacing factor of concentric neutral wires

Variables for Sequence Impedance Equations

Conductor Resistance (R_{ϕ})

The conductor's ac resistance (R_{ϕ}) is calculated by determining the dc resistance, multiplying by the ac/dc ratio, and then adjusting for temperature. The conductor dc resistance and ac/dc ratio are available in Chapter 2 of this manual.

$$R_{\phi} = R_{dcT} \cdot R_{ac/dc} \text{ ohms}/1000 \text{ feet} \quad (6-72)$$

For Copper:

$$R_{dcT} = R_{dc} \cdot \left[\frac{234 + T_c}{234 + T_i} \right] \text{ ohms}/1000 \text{ feet} \quad (6-73)$$

For Aluminum:

$$R_{dcT} = R_{dc} \cdot \left[\frac{228 + T_c}{228 + T_i} \right] \text{ ohms}/1000 \text{ feet} \quad (6-74)$$

where: R_{dcT} = dc resistance of the phase conductor adjusted for temperature in ohms per 1000 feet

$R_{ac/dc}$ = ac/dc resistance ratio of the phase conductor (Chapter 2, Table 2-7)

R_{dc} = dc resistance of a phase conductor at 25°C in ohms Per 1000 feet (Chapter 2, Table 2-6)

T_c = operating temperature of the conductor in degrees C

T_i = initial or reference temperature of the dc resistance in degrees C

Shield Resistance

The shield resistance is calculated by determining the effective shield resistance in accordance with ICEA P-45-432 and then adjusting for temperature. As a practical matter, it is not necessary to adjust the dc shield resistance for ac effects. The shield tape thickness and wire diameters are small, resulting in negligible 60 cycle skin effect.

Helically Applied Copper Tape (R_s)

$$R_s = R_{dcT} \text{ ohms}/1000 \text{ feet} \quad (6-75)$$

$$R_{dcT} = R_{dc} \cdot \left(\frac{234 + T_s}{234 + T_i} \right) \text{ ohms}/1000 \text{ feet} \quad (6-76)$$

$$R_{dc} = \frac{\rho_c}{A_s} \cdot 1000 \text{ ohms}/1000 \text{ feet} \quad (6-77)$$

$$A_s = 4 \cdot b \cdot d_m \cdot \sqrt{\frac{100}{2 \cdot (100 - L)}} \text{ cmils} \quad (6-78)$$

where: R_s = effective shield resistance in ohms per 1000 feet

R_{dcT} = dc resistance of tape shield, corrected for temperature, in ohms per 1000 feet

T_s = operating temperature of the shield in degrees C

T_i = initial or reference temperature dc resistance in degrees C

R_{dc} = dc resistance of tape shield at 25°C in ohms per 1000 feet

ρ_c = resistivity of copper tape shield in ohms-cmil per foot (10.575 for uncoated copper at 25°C)

- A_s = effective area of shield in circular mils
 B = thickness of shield tape in mils
 d_m = mean diameter of shield in mils (d_m equals diameter under the metallic shield plus two times tape thickness)
 L = lap of tape shield in percent

Helically Applied Copper Wire Shield or Concentric Neutral (R_n)

$$R_n = R_{ndcT} \text{ ohms / 1000 feet} \quad (6-79)$$

$$R_{ndcT} = R_{ndcL} \cdot \left[\frac{234 + T_n}{234 + T_i} \right] \text{ ohms / 1000 feet} \quad (6-80)$$

$$R_{ndcL} = R_{ndc} \cdot \frac{LF + \Pi}{LF} \text{ ohms / 1000 feet} \quad (6-81)$$

$$R_{ndc} = \frac{\rho_c \cdot 1000}{N \cdot (1000 \cdot D_n)^2} \text{ ohms / 1000 feet} \quad (6-82)$$

where: R_n = effective resistance of the concentric neutral (or wire shield) in ohms per 1000 feet

R_{ndcT} = dc resistance of the concentric neutral, adjusted for temperature, in ohms per 1000 feet

T_n = operating temperature of the concentric neutral wires in degrees C

T_i = initial or reference temperature for dc resistance in degrees C

R_{ndcL} = dc resistance of the concentric neutral, adjusted for lay length, in ohms per 1000 feet

R_{ndc} = dc resistance of the concentric neutral in ohms per 1000 feet

LF = the lay factor of the helically applied shield tape or shield wires, as applicable

ρ_c = resistivity of copper tape shield in ohms-cmil per foot (10.575 for uncoated copper at 25°C)

N = the number of shield or neutral wires

D_n = diameter of an individual shield or neutral wire in inches

Longitudinally Corrugated Copper Tape Shield (R_s)

$$R_s = R_{tdcT} \text{ ohms / 1000 feet} \quad (6-83)$$

$$R_{tdcT} = R_{tdc} \cdot \left[\frac{234 + T_s}{234 + T_i} \right] \text{ ohms / 1000 feet} \quad (6-84)$$

$$R_{tdc} = \frac{\rho_c \cdot F}{A_s} \cdot 1000 \text{ ohms / 1000 feet} \quad (6-85)$$

$$A_s = 1270 \cdot [\Pi \cdot (D_i \cdot 0.050) + B] \cdot b \text{ cmil} \quad (6-86)$$

where: R_s = effective shield resistance in ohms per 1000 feet
 R_{dcT} = dc resistance of a tape shield, corrected for temperature, in ohms per 1000 feet
 T_s = operating temperature of the shield in degrees C
 T_i = initial or reference temperature for dc resistance in degrees C
 R_{dc} = dc resistance of a tape shield at 25°C in ohms per 1000 feet
 ρ = resistivity of copper tape shield in ohms-cmil per foot (10.575 for uncoated copper at 25°C)
 F = the increase in length factor for longitudinally corrugated tapes (LCT)
 A_s = effective area of shield in circular mils
 D_i = diameter under the metallic shield in inches
 B = longitudinal tape overlap in inches
 b = thickness of shield tape in mils

A typical value for longitudinal tape overlap (B) is 0.5 inches. The increase in length factor (F) takes into account the tape corrugations and is typically 1.2.

Mean Depth of Earth Return (D_e)

$$D_e = 3346 \cdot \sqrt{\rho} \quad \text{ohms-meter} \quad (6-87)$$

where: ρ = earth resistivity in ohms-meter

An average earth resistivity of 100 ohms-meter is often used in these calculations. Soil resistivity can vary with temperature and moisture content. The typical range is from 0.1 ohms-meter for sea water to 1,000 ohms-meter for dry soil.

Concentric Neutral or Wire Shield Spacing Factor (K_n)

$$K_n = N^{\frac{1}{1-N}} \quad (6-88)$$

where: N = the number of shield or neutral wires

Geometric Mean Distance (GMD_ϕ)

Three Conductor Cables

$$GMD_\phi = D_0 \quad \text{inches} \quad (6-89)$$

Triplexed Single Cables

$$GMD_\phi = OD \quad \text{inches} \quad (6-90)$$

Parallel-Laid Cables

$$GMD_\phi = \sqrt[3]{d_{ab} \cdot d_{bc} \cdot d_{ac}} \quad \text{inches} \quad (6-91)$$

where: D_0 = diameter over the metallic shield in inches
 OD = overall single cable diameter in inches
 d_{ab}, d_{bc}, d_{ac} = center-to-center distance between respective phases a, b, and c in inches

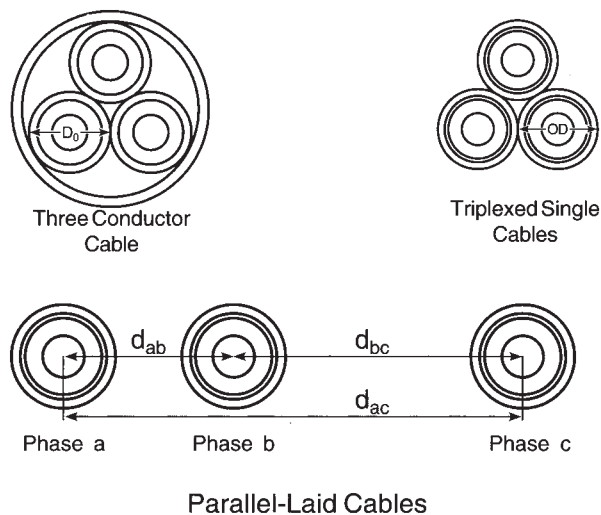

Figure 6-25
Conductor Spacing

Geometric Mean Radius (GMR_{ϕ})

Phase Conductor (GMR_{ϕ})

TABLE 6-29

GMR OF CLASS B STRANDED COPPER AND ALUMINUM CONDUCTORS				
Conductor Size (AWG or kcmil)	No. of Strands	Round (inches)	Compressed (inches)	Compact (inches)
8	7	0.053	-	-
6	7	0.067	-	-
4	7	0.084	-	-
2	7	0.106	0.105	-
1	19	0.126	0.124	0.117
1/0	19	0.141	0.139	0.131
2/0	19	0.159	0.156	0.146
3/0	19	0.178	0.175	0.165
4/0	19	0.200	0.197	0.185
250	37	0.221	0.216	0.203
350	37	0.261	0.256	0.240
500	37	0.312	0.305	0.287
750	61	0.383	0.377	0.353
1000	61	0.442	0.435	0.413

Metallic Shield (GMR_s)

$$GMR_s = \frac{D_i + 2T}{2} \text{ inches} \quad (6-92)$$

where: D_i = diameter under the metallic shield in inches

T = thickness of shield tape in inches

Single Neutral Strand (GMR_n)

$$GMR_n = 0.3894 \cdot D_n \text{ inches} \quad (6-93)$$

where: D_n = diameter of an individual shield or neutral wire in inches

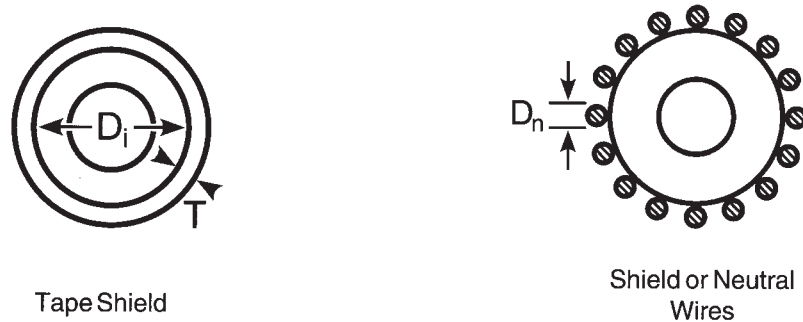

Figure 26
Shield Diameters

Typical Calculation

The following calculations illustrate how to determine the positive-, negative-, and zero-sequence impedances for three 15kV (133%) rated medium voltage cables arranged in a horizontal spaced configuration with center-to-center distances of 8, 8, and 16 inches respectively. The individual single conductor cables have a 500 kcmil stranded bare compressed copper conductor, a 0.220 inch wall of EPR insulation, a shield of 0.005 inch thick helically applied copper tape with a lap of 12.5%, and an overall jacket. The typical case of bonded and grounded shield(s) plus earth return shall apply.

1. Determine the effective conductor resistance (R_{ϕ}):

- a. Determine the operating temperature of the conductor (T_o) and the reference temperature (T_i):

$$T_i \text{ given as } 25^{\circ}\text{C, and } T_o \text{ as } 90^{\circ}\text{C}$$

- b. Next, determine the dc conductor resistance (R_{dc}) by first determining the dc resistance per the published conductor tables in Chapter 2:

$$R_{dc} = 0.0216 \text{ ohms per 1000 ft. at } 25^{\circ}\text{C}$$

- c. Adjust the conductor resistance for the operating temperature (R_{90}) using equation 6-73:

$$\begin{aligned} R_{90} &= R_{dc} \cdot \left[\frac{234 + T_o}{234 + T_i} \right] \\ &= 0.0216 \cdot \frac{234 + 90}{234 + 25} \\ &= 0.0270 \text{ ohms / 1000 feet} \end{aligned}$$

- d. Adjust the dc conductor resistance (R_{90}) for ac skin and proximity effects ($R_{ac/dc}$) using equation 6-72. $R_{ac/dc}$ is found in Table 2-7 of Chapter 2. In this calculation, $R_{ac/dc}$ is equal to 1.06.

$$\begin{aligned} R_{\phi} &= R_{90} \cdot R_{ac/dc} \\ &= 0.0270 \cdot 1.06 \\ &= 0.0286 \text{ ohms per 1000 feet} \end{aligned}$$

2. Determine the shield resistance of the helically applied copper tape shield (R_s):

a. Determine the "effective area" of the helically applied copper tape shield (A_s):

Convert the shield tape thickness (b) to mils:

$$\begin{aligned} b &= 1000 \cdot T \\ &= 1000 \cdot 0.005 \\ &= 5 \text{ mils} \end{aligned}$$

Determine the mean diameter of the shield (d_m):

$$\begin{aligned} d_m &= 1000 \cdot (D_i + 2 \cdot T) \\ &= 1000 \cdot [1.400 + (2 \cdot 0.005)] \\ &= 1410 \text{ mils} \end{aligned}$$

Determine the effective area of the shield (A_s) using equation 6-78:

$$\begin{aligned} A_s &= 4 \cdot b \cdot d_m \cdot \sqrt{\frac{100}{2 \cdot (100 - L)}} \\ &= 4 \cdot 5 \cdot 1410 \cdot \sqrt{\frac{100}{2 \cdot (100 - 12.5)}} \\ &= 21,320 \text{ circular mils} \end{aligned}$$

b. Determine the dc resistance of the tape shield (R_{tdc}) using equation 6-77:

$$\begin{aligned} R_{tdc} &= \frac{\rho_c}{A_s} \cdot 1000 \\ &= \frac{10.575}{21,320} \cdot 1000 \\ &= 0.496 \text{ ohms per 1000 feet} \end{aligned}$$

c. Determine the operating temperature of the shield (T_s), and the reference temperature (T_i):

T_i is given as 25°C, and T_s as the typical value of 45°C

d. Adjust the shield resistance for an operating temperature of 45°C (R_{t45}) using equation 6-76:

$$\begin{aligned} R_{t45} &= R_{tdc} \cdot \left[\frac{234 + T_s}{234 + T_i} \right] \\ &= 0.496 \cdot \left[\frac{234 + 45}{234 + 25} \right] \\ &= 0.534 \text{ ohms per 1000 feet} \end{aligned}$$

- e. As a practical matter, it is not necessary to adjust the dc shield resistance for ac effects (R_s) because tape shields are very thin when compared to the 60 cycle skin depth, therefore:

$$R_s = R_{t45} = 0.534 \text{ ohms per 1000 feet}$$

3. Determine the mean depth of the earth return (D_e), where the earth resistivity (ρ) is 100 ohm-meters, using equation 6-87:

$$\begin{aligned} D_e &= 3346 \cdot \sqrt{\rho} \\ &= 3346 \cdot \sqrt{100} \\ &= 33,460 \text{ inches} \end{aligned}$$

4. Determine the geometric mean distance (GMD_ϕ) between phase conductors using equation 6-91:

$$\begin{aligned} d_{ab} &= 8 \text{ inches, } d_{bc} = 8 \text{ inches, } d_{ac} = 16 \text{ inches} \\ GMD_\phi &= \sqrt[3]{d_{ab} \cdot d_{bc} \cdot d_{ac}} \\ &= \sqrt[3]{8 \cdot 8 \cdot 16} \\ &= 10.079 \text{ inches} \end{aligned}$$

5. Determine the geometric mean radius of the conductor (GMR_o) and the shield (GMR_s).
- a. Determine the geometric mean radius (GMR_o) of the compressed conductor from Table 6-29:

$$GMR_o \text{ of 500 kcmil, 37 strand conductor} = 0.305 \text{ inches}$$

- b. Determine the geometric mean radius (GMR_s) of the shield. GMR_s is measured from the center of the phase conductor to the middle of the tape shield. Given an innermetallic shield diameter (D_i) of 1.4 inches, calculate the GMR_s using equation 6-92:

$$\begin{aligned} GMR_s &= \frac{D_i + 2 \cdot T}{2} \\ &= \frac{1.400 + 2 \cdot 0.005}{2} \\ &= 0.705 \text{ inches} \end{aligned}$$

6. Calculate individual impedances of Z_{aa} , Z_{ab} , Z_{asr} and Z_{ssr} in ohms per 1000 feet, using the equations for tape shielded medium voltage cables (6-55, 6-56, 6-57, and 6-58):

$$Z_{aa} = 0.047 + 0.267j$$

$$Z_{ab} = 0.018 + 0.186j$$

$$Z_{as} = 0.018 + 0.247j$$

$$Z_{ss} = 0.552 + 0.247j$$

7. Finally calculate the positive- and negative-sequence (Z_1) and zero-sequence (Z_0) impedances, in ohms per 1000 feet, using the equations for tape shielded medium voltage cables (6-53 and 6-54):

$$Z_1 = 0.036 + 0.080j$$

$$Z_0 = 0.333 + 0.262j$$

5kV

TABLE 6-30

CABLE SEQUENCE IMPEDANCE DATA IN OHMS/1000 FEET				
Size (AWG or kcmil)	Three Single Conductor Cables		Three Conductor Cable	
	Positive/Negative	Zero	Positive/Negative	Zero
2	0.210+j0.103	0.487+j0.506	0.205+j0.044	0.057+j0.555
1	0.168+j0.099	0.452+j0.488	0.163+j0.042	0.521+j0.531
1/0	0.134+j0.097	0.428+j0.462	0.129+j0.042	0.493+j0.495
2/0	0.108+j0.094	0.406+j0.444	0.103+j0.040	0.469+j0.473
3/0	0.087+j0.091	0.389+j0.426	0.082+j0.039	0.449+j0.449
4/0	0.070+j0.089	0.376+j0.407	0.065+j0.038	0.433+j0.425
250	0.060+j0.087	0.369+j0.387	0.055+j0.038	0.422+j0.401
350	0.046+j0.083	0.357+j0.355	0.040+j0.036	0.404+j0.363
500	0.035+j0.079	0.344+j0.314	0.029+j0.034	0.384+j0.316
750	0.027+j0.074	0.329+j0.268	0.021+j0.032	0.361+j0.265
1000	0.023+j0.070	0.317+j0.237	0.017+j0.031	0.343+j0.233

15kV

Size (AWG or kcmil)	Three Single Conductor Cables		Three Conductor Cable	
	Positive/Negative	Zero	Positive/Negative	Zero
2	0.210+j0.103	0.518+j0.412	0.205+j0.052	0.574+j0.428
1	0.168+j0.099	0.478+j0.396	0.164+j0.049	0.531+j0.410
1/0	0.134+j0.097	0.445+j0.383	0.129+j0.048	0.496+j0.394
2/0	0.108+j0.094	0.419+j0.368	0.103+j0.046	0.468+j0.376
3/0	0.087+j0.091	0.398+j0.352	0.082+j0.044	0.444+j0.358
4/0	0.070+j0.089	0.381+j0.334	0.065+j0.043	0.424+j0.338
250	0.060+j0.087	0.370+j0.316	0.055+j0.039	0.412+j0.317
350	0.046+j0.083	0.351+j0.291	0.040+j0.040	0.386+j0.289
500	0.035+j0.079	0.334+j0.261	0.029+j0.038	0.364+j0.258
750	0.027+j0.074	0.315+j0.227	0.021+j0.036	0.339+j0.222
1000	0.023+j0.070	0.301+j0.201	0.017+j0.034	0.320+j0.195

25kV

Size (AWG or kcmil)	Three Single Conductor Cables		Three Conductor Cable	
	Positive/Negative	Zero	Positive/Negative	Zero
1	0.168+j0.099	0.480+j0.374	0.164+j0.051	0.529+j0.383
1/0	0.134+j0.097	0.446+j0.361	0.129+j0.050	0.493+j0.368
2/0	0.108+j0.094	0.419+j0.347	0.103+j0.048	0.463+j0.352
3/0	0.087+j0.091	0.397+j0.328	0.082+j0.046	0.438+j0.330
4/0	0.070+j0.089	0.379+j0.311	0.065+j0.045	0.416+j0.312
250	0.060+j0.087	0.366+j0.296	0.055+j0.044	0.402+j0.295
350	0.046+j0.083	0.347+j0.273	0.040+j0.041	0.378+j0.270
500	0.035+j0.079	0.329+j0.246	0.029+j0.039	0.356+j0.241
750	0.027+j0.074	0.308+j0.211	0.021+j0.038	0.329+j0.206
1000	0.023+j0.070	0.296+j0.190	0.018+j0.035	0.313+j0.184

35kV

Size (AWG or kcmil)	Three Single Conductor Cables		Three Conductor Cable	
	Positive/Negative	Zero	Positive/Negative	Zero
1/0	0.134+j0.097	0.442+j0.316	0.130+j0.053	0.480+j0.316
2/0	0.108+j0.094	0.414+j0.304	0.103+j0.051	0.449+j0.303
3/0	0.087+j0.091	0.391+j0.291	0.082+j0.049	0.424+j0.289
4/0	0.070+j0.089	0.371+j0.277	0.065+j0.048	0.402+j0.274
250	0.060+j0.087	0.358+j0.263	0.055+j0.046	0.386+j0.259
350	0.046+j0.083	0.338+j0.243	0.040+j0.044	0.363+j0.238
500	0.035+j0.079	0.317+j0.217	0.029+j0.043	0.338+j0.212
750	0.027+j0.074	0.297+j0.190	0.021+j0.040	0.314+j0.184
1000	0.023+j0.070	0.283+j0.172	0.017+j0.037	0.298+j0.166

- Tables are based on the following:
- Three single conductor cables spaced horizontally 7.5 inches center to center.
 - Three conductor cables triplexed, paralleled or cradled.
 - Conductor temperature of 90°C with a shield temperature of 45°C.
 - Copper tape shield resistivity of 10.575 ohms/cmil-ft at 25°C.
 - Earth resistivity of 100 ohms-meter.
 - Tape Shield thickness of 0.005 inches helically applied with 12.5% lap.

CABLE INSTALLATION

Cables installed into conduits or trays have installation parameters such as maximum pulling tensions, sidewall pressure, clearance, and jamming, which must be considered. Other installations, such as buried and aerial, have different installation parameters. Most installations involve some general considerations, such as field handling, storage, training of ends, and junction box sizes. These and other considerations can make the difference between a good installation and one resulting in damaged cable.

Cable damaged during installation can cause service failures. Mechanical stresses during installation are generally more severe than those encountered while in service.

The following information provides guidance in recognizing these conditions and provides a methodology to aid in keeping them within acceptable limits.

GENERAL FIELD PRACTICES

Introduction

The small details can make the difference between successful installations and having to remove damaged cable. In preparing for a cable pull, it is just as important to cover the small details as it is to assure that the cable does not exceed maximum sidewall pressure; minimum bending radii and maximum pulling tensions. General field practices are provided to aid in preparing for large and small cable installations.

Preplanning

Preplanning for a pull is very important and should include the following steps:

1. Review all applicable local, state, and federal codes.
2. Consult local inspector.
3. Consult applicable information provided by national standards, cable manufacturers, and accessory and other suppliers.
4. Check cable for:
 - a. Correct size and type
 - b. Shipping damage
 - c. End seals
 - d. Special instructions
5. Check reels for:
 - a. Damage
 - b. Protruding nails that might damage cable
 - c. Staples

6. Consult equipment and cable manufacturer for approval of proper pulling equipment:
 - a. When using wood reels, use reel jack stands to support an axle through the arbor hole during payoff.
 - b. Steel reels or special reinforced wood reels are acceptable for use with electric roller payoff methods. *Caution: Electric rollers can severely damage or completely collapse non-reinforced wood reels during installation.*

Low Ambient Temperature

Low temperatures are a cause for concern when installing cables. Cable should be handled more carefully and pulled more slowly during cold weather. When cables are to be installed in cold weather, they should be kept in heated storage for at least 24 hours before installation. Cables should not be installed at ambient temperatures lower than the following:

Type of Insulation or Jacket	Minimum Temperature for Installation	
PVC	-10°C	14°F
EPR	-40°C	-40°F
PE	-40°C	-40°F
XLPE	-40°C	-40°F
SOLONON	-40°C	-40°F
PVC (Arctic)	-40°C	-40°F
CSPE (Hypalon®) or CPE	-20°C	-4°F

In climates where there are large temperature swings either intermittently or from summer to winter, jacket movement and shrinkback can occur at splices and terminations. This is probably due to a ratcheting effect associated with the expansion and contraction cycles of the environment and cable. Under certain conditions, terminations may allow entry of moisture and contaminants into the cable, thus precipitating insulation failure. Mechanical restraints, such as hose clamps and shrinkable sleeves that extend over part of the jacket and termination, that apply pressure at those points, have proven to be effective at restraining the jacket movement.¹

Equipment

Some of the equipment and arrangements used to install cable are illustrated in the following figures:

- a) At the feed-in, the curvature of the cable feed is in the same continuous arc with no reverse bends. At the pull-out, the pulling rope exits the duct directly to a pulling sheave.

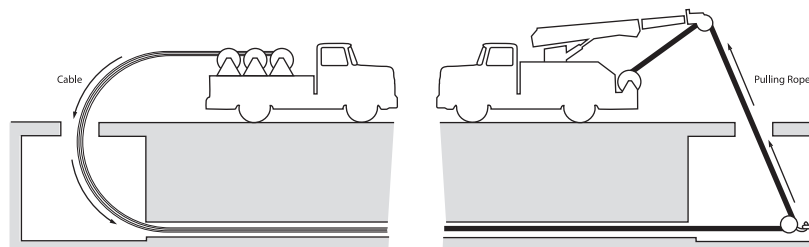

Figure 7-1
Pulling Cable in Duct

¹ IEEE 532-1993 "Guide for Selecting and Testing Jackets for Underground Cables."

- b) The cable is fed from the cable reel directly into the conduit at floor level. The cable is fed from the bottom of the reel so that its curvature is continuous with no reversed bends.

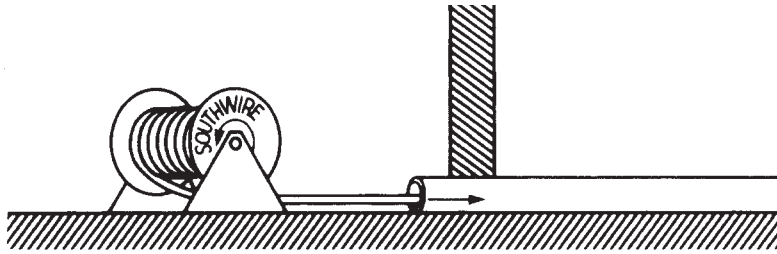

Figure 7-2
Cable Feed into Conduit at Floor Level

- c) From cable reel to cable tray, the cable is fed from the top of the reel to maintain required curvature. Sheaves, or a shoe, may be used to guide the cable into the tray.

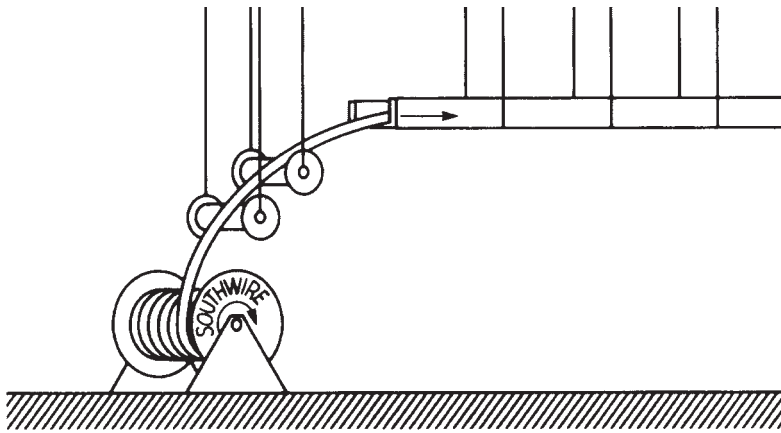

Figure 7-3
Cable Feed into Cable Tray

- d) Cable sheaves or a shoe may be used to guide cable into the desired direction, maintain minimum bend radius, and reduce friction. Examples of proper and improper sheave arrangements are illustrated in the following figures.

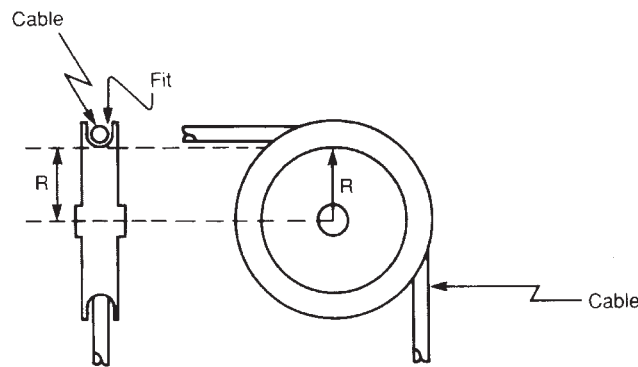

Figure 7-4
Single Sheave for 90° Change of Direction
(R is radius used to calculate sidewall pressure, SP)

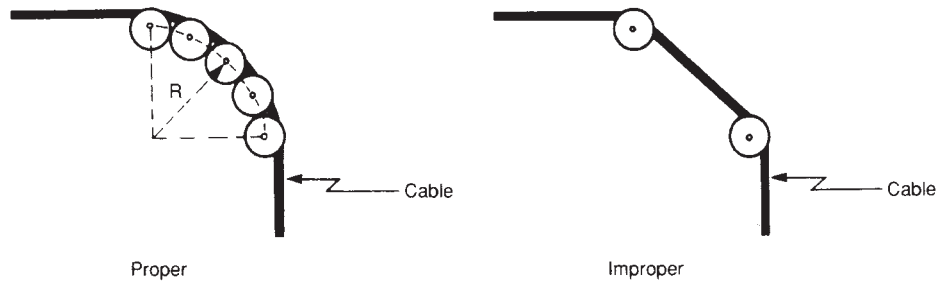

Figure 7-5
Multiple Sheaves

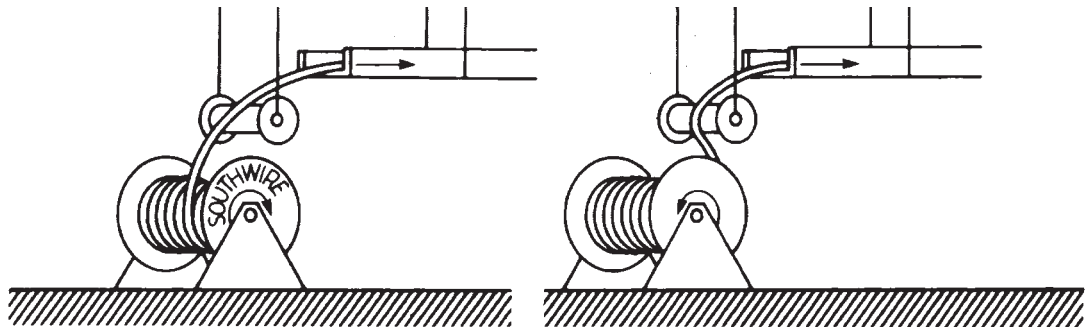

Figure 7-6
Sheave Arrangements for Feeding into Cable Tray

Training Radius

The training radius is the final positioning of cable ends after the cable has been placed in the raceway. These limits should not be used for cables subjected to pulling tensions during installation.

Larger bend radii shall be considered for conduit bends, sheaves, or other curved surfaces around which the cable may be pulled under tension while being installed, due to sidewall bearing pressure limits (Table 7-1) of the cable.

TABLE 7-1
600 VOLT CABLE CONSTRUCTIONS
RECOMMENDED MINIMUM BENDING RADII

Cable Construction	Multiple of Cable O.D.
Type MC (Metal Clad) Cables (NEC 330.24)	
a) Interlocked or Corrugated Sheath	7
b) Smooth Sheath	
- Max diameter 0.750 inches	10
- Max diameter 1.500 inches	12
- Diameter larger than 1.500 inches	15
c) Shielded Conductors	12/7*
Type TC (Tray Cable) (NEC 336.24) Single or Multiconductor Assembly (ICEA S-95-658)	
a) Diameter 1.0 inch or less	4
b) Diameter between 1.0 inch to 2.0 inches	5
c) Diameter larger than 2.0 inches	6
d) Metallic Shielding	12

*12 times individual shielded conductor diameter or 7 times overall cable diameter, whichever is greater.

TABLE 7-2

OVER 600 VOLT CABLE CONSTRUCTIONS RECOMMENDED MINIMUM BENDING RADII	
Single and Multiple Conductors (NEC 300.34)	Multiple of Cable O.D.
Shielded and Lead Covered	12
Nonshielded and Nonarmored	8
Multiconductor or Multiplexed Cable	12/7*

*12 times individual shielded conductor diameter or 7 times overall cable diameter, whichever is greater.

A nonshielded cable can tolerate a sharper bend than a shielded cable. When bent too sharply, helical metal tapes can separate, buckle, and cut into the insulation. This problem is compounded by jackets concealing such damage. Corona problems related to metal shield damage may be initially masked by the semiconductive shielding bedding tapes or extruded polymers.

Handling and Storage Guidelines

- Unloading equipment should not come in contact with the cable or its protective covering.
- If a crane is used to unload cable, a shaft through the arbor hole or a cradle supporting both reel flanges should be used.
- Forklifts must lift the reel by contacting both flanges.
- Ramps must be wide enough to support both reel flanges.
- Store reels on hard surface so that the flanges will not sink and allow reel weight to rest on cable.

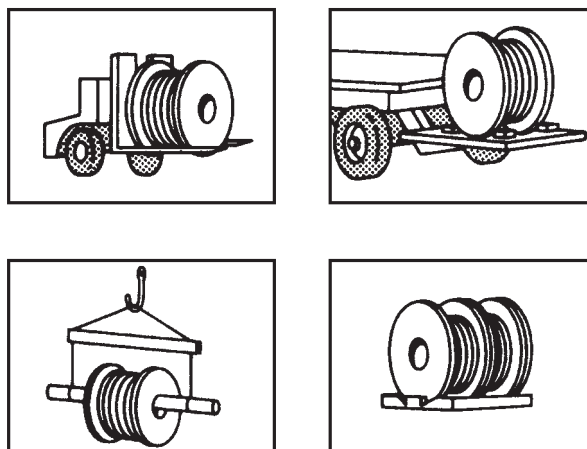

Figure 7-7
Proper Reel Handling

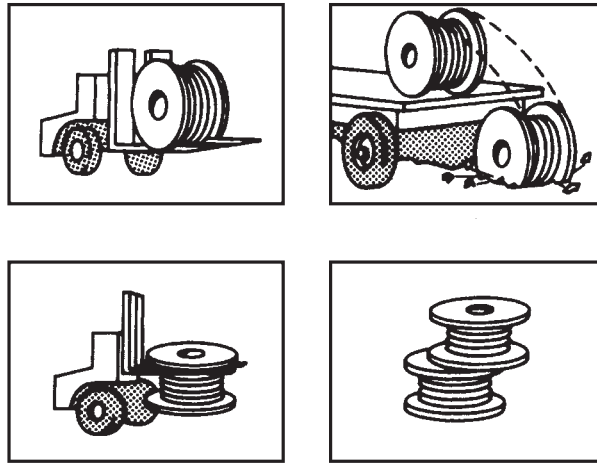

Figure 7-8
Improper Reel Handling

- f. Reels should be stored out of harm's way. Consider both physical and environmental hazards.
- g. Cable ends must always be sealed to prevent the entrance of moisture, etc.
- h. Remove temporary cable lashing.
- i. While pulling, in order to eliminate sharp bend and crossovers, always have a person feed the cable(s) straight into the conduit by hand or, for larger cables, over a large diameter sheave.

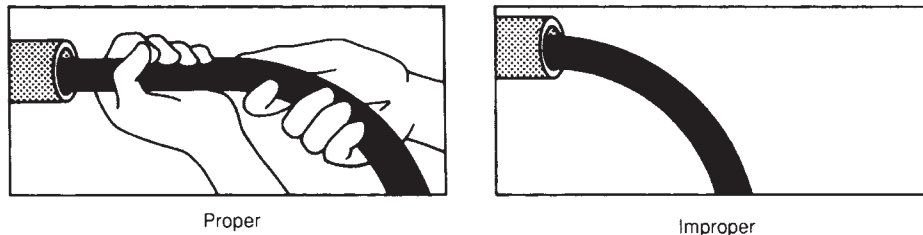
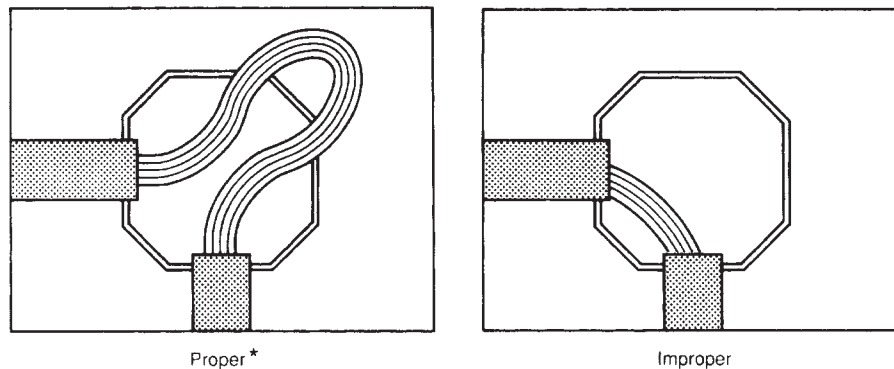

Figure 7-9
Feed Into Conduit

- j. Do not pull cable directly across short, sharp angles. After pulling completely out of one side of the enclosure, feed cable into the other side of the enclosure and pull that segment.



*Caution: Minimum bending radii must be maintained.

Figure 7-10
Pull-Through Enclosure

Dynamometer Corrections

The dynamometer reading (R) is dependent upon the angle of pulling line (β) from the cable to the dynamometer idler and then to the pulling mechanism; therefore, a correction to the dynamometer reading may be required to obtain the actual pulling tension (T).

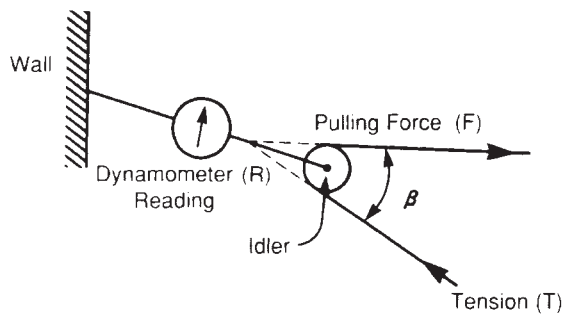

Figure 7-11
Variables for Dynamometer Correction Equation

$$T = R \cdot \left[\frac{1}{2 \cos\left(\frac{\beta}{2}\right)} \right] - W \quad (7-1)$$

where: R = dynamometer reading, in pounds
 β = angle between pulling line, in degrees
 W = tare weight of idler pulley assembly, in pounds

Example:

What is the actual pulling tension of a cable pull where the dynamometer reading is 5000 pounds, the angle of the pulling line is 45° , and the tare weight of the idler assembly is 15 pounds? Using (7-1):

$$T = 5,000 \cdot \left[\frac{1}{2 \cos\left(\frac{45}{2}\right)} \right] - 15$$

$$T = 2,690 \text{ pounds}$$

Diameters of Nonjacketed Cable Assemblies

The overall diameters of the cables in a multiple conductor assembly are used in determining the circumscribed diameter of that assembly

$$D_A = d \cdot \text{Factor} \tag{7-2}$$

where: D_A = circumscribed diameter of assembly

d = diameter of one cable of assembly

Factor = for the following list

Number of Cables	Factor
1	1.000
2	2.000
3	2.155
4	2.414
5	2.700
6	3.000
7	3.000
8	3.310
9	3.610

Pull Boxes

To estimate the size of a pull box, take the greater of:

For Straight Pulls

$$L \geq 48xD_S$$

$$L \geq 32xD_N$$

For Angle or "U" Pulls

$$L_o \geq (24xD_N) + (D_1 + D_2 + \dots)$$

$$L_o \geq (24xD_N) + (D_1 + D_2 + \dots)$$

$$L_A \geq 36xD_S$$

$$L_A \geq 24xD_N$$

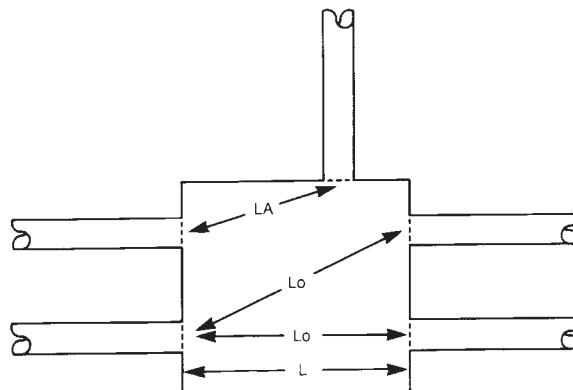

Figure 7-12
Pull Box Dimensions

where: L = minimum box length, in inches

L_o = minimum distance between cable entry and exit on the the opposite side of the box, in inches

L_A = minimum distance between the cable entry and the exit of the adjacent walls of the box, in inches

D_s = diameter of the largest shielded cable, in inches

D_N = diameter of the largest nonshielded cables, in inches

D, D_2, \dots = diameters of the remaining cable entering through the same wall of the box, in inches

For more information on sizing of pull and junction boxes, refer to the NEC Article 314. Information on spacing of conductors at pull and junction boxes is presented in Table 7-3.

TABLE 7-3

CONDUIT SPACING (INCHES)												
CENTER-TO-CENTER SPACING												
Size	1/2	3/4	1	1 1/4	1 1/2	2	2 1/2	3	3 1/2	4	5	6
1/2	1.38											
3/4	1.50	1.62										
1	1.75	1.88	2.00									
1 1/4	2.00	2.12	2.25	2.50								
1 1/2	2.12	2.25	2.38	2.62	2.75							
2	2.38	2.50	2.75	3.00	3.12	3.38						
2 1/2	2.62	2.75	3.00	3.25	3.38	3.00	4.00					
3	3.00	3.12	3.38	3.62	3.75	4.00	4.38	4.75				
3 1/2	3.38	3.50	3.62	3.88	4.00	4.38	4.62	5.00	5.38			
4	3.69	3.88	4.00	4.25	4.38	4.75	5.00	5.38	5.62	6.00		
5	4.38	4.50	4.62	4.88	5.00	5.38	5.62	6.00	6.25	6.62	7.25	
5	5.00	5.12	5.25	5.50	5.62	6.00	6.25	6.62	7.00	7.25	8.00	8.62

Cable Lubrication Selection

1. Reducing the coefficient of friction is the primary factor in the selection of a lubricant.
2. Compatibility of the lubricant with cable and conduit is extremely important. The lubricant should not have any deleterious effects on the conduit or on the physical or electrical properties of the cable insulation, semiconducting, or jacket materials.
3. The lubricant and its residue should not propagate flame.
4. The lubricant should be UL or CSA listed.
5. The lubricant should contain no waxes or greases.

Use

The cable jacket and/or conduit walls should be completely lubricated. The lubricant should be applied immediately before, and/or, during the pull. This quantity should be increased as needed for difficult pulling situations.

An estimate of the quantity of required lubricant can be determined from.²

$$Q = (0.0015) \cdot L \cdot D \quad (7-3)$$

where: Q = quantity, in gallons

L = conduit length, in feet

D = outside diameter of cable or inside diameter of conduit, in inches

INSTALLATION IN CONDUIT

Calculations should be made to indicate whether the pull looks “easy” or “impossible,” making the decision to pull an obvious choice. When a “marginal” situation is encountered, the entire pull should be reviewed. This review may include more rigorous calculations or trial pulls. A final decision should be made based on installation factors known to the end user and installer.

The sizes of the conduit are determined based on the calculations of the clearances, jamming, and fill. Pulling tensions may then be evaluated by determining the maximum tension based on the pulling device used and the maximum tension that can be applied to the conductors. The lesser of these two values is the maximum allowable tension (T_m).

The pulling tension (T) required to pull the cable through the conduit is then calculated and compared to the maximum allowable tension. If the pulling tension exceeds the allowable tension, then conditions should be changed to ensure a successful pull.

After calculating pulling tensions, sidewall pressures (SP) may be calculated.

For further study on this subject, AEIC Publication G5-90 and IEEE Standard 1185 present additional details.³

Allowable Tension on Pulling Device

Do not exceed the allowable tension stated by the manufacturer of the pulling eye or 10,000 pounds, whichever is less. Traditional conservative practices limit the allowable tension of a basket grip to 1,000 pounds. Under specific conditions, this limit can be safely exceeded.

Maximum Tension on Cable Conductors

The conductors of the cable are generally the only members that can bear the pulling forces without damage. Do not use metallic shielding wires, tapes, braids or armor not designed for the purpose in pulling tension calculations.

² Polywater, “Technical Talk,” volume 4.

³ AEIC Publication no G5-90, “Underground Extruded Power Cable Pulling, AEIC Task Group 28,” 2nd edition, May 2001; and IEEE Standard 1185-1994, “Guide for Installation Methods for Generating Station Cables.”

Definitions for the following equations and examples:

- T_c = tension on each conductor, in pounds
- S = allowable stress from Table 7-4, in pounds/cmil
- A = area of each conductor, in cmil
- N = number of conductors
- T_{cable} = maximum allowable tension in the cable in pounds
- T_{device} = maximum allowable tension on device in pounds
- T_m = maximum allowable tension is the lesser of T_{device} or T_{cable} in pounds

TABLE 7-4

MAXIMUM ALLOWABLE CONDUCTOR STRESS (S)			
Cable Type	Material	Temper	lb/cmil
All	Copper	Soft	0.008
Power	Aluminum	Hard	0.008
Power	Aluminum	3/4 Hard	0.006
Power	Aluminum	AA-8000*	0.006
URD	Aluminum	1/2 Hard	0.003
Solid	Aluminum	Soft	0.002

*3/4 hard aluminum is allowed for power cable. The 2005 NEC defines use of AA-8000 for solid (8, 10, and 12 AWG) and stranded (8 AWG through 1000 kcmil) conductors.

TABLE 7-5

CONDUCTOR AREA			
Size	Cross-Sectional Area		
AWG or kcmil	cmil	inches²	mm²
14	4110	0.00323	2.082
12	6530	0.00513	3.308
10	10,380	0.00816	5.261
8	16,510	0.01297	8.368
7	20,820	0.01635	10.55
6	26,240	0.02061	13.30
5	33,090	0.02599	16.77
4	41,740	0.03278	21.15
3	52,620	0.04133	26.66
2	66,360	0.05212	33.63
1	83,690	0.06573	42.41
1/0	105,600	0.08291	53.49
2/0	133,100	0.1045	67.42
3/0	167,800	0.1318	85.03
4/0	211,600	0.1662	107.2
250	250,000	0.1963	126.6
300	300,000	0.2356	152.0
350	350,000	0.2749	177.4
400	400,000	0.3142	202.7
450	450,000	0.3534	228.0
500	500,000	0.3927	253.4
550	550,000	0.4320	278.7
600	600,000	0.4712	304.0
650	650,000	0.5105	329.4
700	700,000	0.5498	354.7
750	750,000	0.5890	380.0
800	800,000	0.6283	405.4
900	900,000	0.7069	456.1
1000	1,000,000	0.7854	506.7

Single Conductors

$$T_c = S \cdot A \text{ pounds} \quad (7-4)$$

$$T_{cable} = T_c$$

Example:

Power Cable, single conductor, 4/0 AWG aluminum, hard

$$T_{cable} = (0.008) \cdot (211,600) \text{ pounds}$$

$$T_{cable} = 1,693 \text{ pounds}$$

Multiple Conductors

Multiple conductors in parallel, or multiplexed, and multiple conductor cables.

Three or fewer conductors

$$T_{cable} = N T_c \text{ pounds} \quad (7-5)$$

Example 1: Power cable, two single conductor, 4/0 AWG aluminum, hard

$$T_{cable} = (2) \cdot (1,693) = 3,386 \text{ pounds}$$

Example 2: Power Cable, three-conductor, 4/0 AWG aluminum, hard

$$T_{cable} = (3) \cdot (1,693) = 5,079 \text{ pounds}$$

More than three conductors

$$T_{cable} = (0.8) \cdot N T_c \text{ pounds} \quad (7-6)$$

Example 3: Control Cable, four conductor, 6 AWG copper

Using equation (E-4):

$$T_{cable} = S \cdot A = (0.008) \cdot (26,240) = 210 \text{ pounds}$$

Using equation (E-6)

$$T_{cable} = (0.8) \cdot N T_c \text{ pounds}$$

$$T_{cable} = (0.8) \cdot 4 \cdot (210) = 672 \text{ pounds}$$

CAUTION:

Pulling different conductor sizes at the same time is not recommended if the conductor size or other cable characteristics are significantly different.

If you must pull different size conductors, it must be done with care. For example, if a run requires three 350 kcmil and three 8 AWG single conductor cables, it would be preferable, though not necessarily ideal, to pull the three 350 kcmil single conduct cables and one three conductor 8 AWG multiple conductor cable at the same time.

Pulling additional cables into an existing conduit system is generally not recommended. If this must be done, extreme caution must be taken. Of special concern is the cutting action of the tensioned pulling rope.

Equations for Pulling Tension

The following equations are used to calculate pulling tension. They include the following variables:

- T_{in} = tension into a section in pounds
- T_{out} = tension out of a section in pounds
- w = weight correction factor, dimensionless
- μ = coefficient of dynamic friction, dimensionless
- W = total cable assembly weight on pounds/foot
- L = straight section length in feet
- θ = straight section angle from horizontal in radians
- ϕ = bend section angle in radians
- R = bend section radius in feet
- e = 2.71 natural logarithm base

Horizontal Straight Section

$$T_{out} = w\mu WL + T_{in} \quad (7-7)$$

Inclined and Vertical Straight Section

Pulling Up a Straight Section

$$T_{out} = WL(\sin\theta + w\mu \cos\theta) + T_{in} \quad (7-8)$$

Pulling Down a Straight Section

$$T_{out} = -WL(\sin\theta - w\mu \cos\theta) + T_{in} \quad (7-9)$$

Horizontal Bend Section

$$T_{out} = T_{in} (\cosh w\mu\phi) + (\sinh w\mu\phi) \cdot \sqrt{T_{in}^2 + (WR)^2} \quad (7-10)$$

Vertical Concave Up Bend

Pulling Up Through a Bend

$$T_{out} = T_{in} e^{w\mu\phi} - \frac{WR}{1+(w\mu)^2} \cdot [2w\mu \sin\phi - (1-(w\mu)^2) \cdot (e^{w\mu\phi} - \cos\phi)] \quad (7-11)$$

Pulling Down Through a Bend

$$T_{out} = T_{in} e^{w\mu\phi} - \frac{WR}{1+(w\mu)^2} \cdot [2w\mu e^{w\mu\phi} \sin\phi + (1-(w\mu)^2) \cdot (1 - e^{w\mu\phi} \cos\phi)] \quad (7-12)$$

Vertical Concave Down Bend

Pulling Up Through a Bend

$$T_{out} = T_{in} e^{w\mu\phi} + \frac{WR}{I + (w\mu)^2} \cdot [2w\mu e^{w\mu\phi} \sin\phi + (I - (w\mu)^2) \cdot (I - e^{w\mu\phi} \cos\phi)] \quad (7-13)$$

Pulling Down Through a Bend

$$T_{out} = T_{in} e^{w\mu\phi} + \frac{WR}{I + (w\mu)^2} \cdot [2w\mu \sin\phi - (I - (w\mu)^2) \cdot (e^{w\mu\phi} - \cos\phi)] \quad (7-14)$$

Commonly Used Approximation for Bends

It is common practice to use the following approximation in lieu of bend equations 7-10, 7-11, 7-13, 7-14, and 7-15

$$T_{out} = T_{in} \cdot e^{w\mu\phi} \quad (7-15)$$

Coefficient of Friction

The coefficient of dynamic friction (μ) is a measure of the friction between a moving cable and the conduit. The coefficient of friction can have a large impact on the tension calculation. It can vary from 0.1 to 1.0 with lubrication and can exceed 1.0 for unlubricated pulls. Typical values for the coefficient of friction are presented in Table 7-2. Pulls should never be stopped and restarted because the coefficient of static friction will always be higher than the coefficient of dynamic friction.

TABLE 7-6

TYPICAL COEFFICIENTS OF DYNAMIC FRICTION (μ) ADEQUATE CABLE LUBRICATION DURING PULL ^(A)				
Cable Exterior	Type of Conduit ^(B)			
	M	PVC	FIB	ASB
PVC – Polyvinyl Chloride	0.4	0.35	0.5	0.5
PE – Low Density HMW Polyethylene	0.35	0.35	0.5	0.5
PO – SOLONON™ (Polyolefin)	0.35	0.35	0.5	0.5
CSPE – Hypalon® (Chlorosulfonated Polyethylene)	0.5	0.5	0.7	0.6
XLPE – Cross-Linked PE	0.35	0.35	0.5	0.5
Nylon	0.4	0.35	0.5	0.5
CPE – Chlorinated PE	0.5	0.5	0.7	0.6

(A) These represent conservative values for use in lieu of more exact information.⁴

(B) Conduit Codes:

- M = metallic, steel or aluminum
- PVC = polyvinyl chloride, thin wall or heavy schedule 40
- FIB = fiber conduit—Orangeburg or Nocrete
- ASB = asbestos cement—Transite or Korduct

The coefficient of friction between a cable exterior (jacket/sheath) and conduit varies with the type of jacket or sheath, type and condition of conduit, type and amount of pulling lubricant used, cable temperature, and ambient temperature. High ambient temperatures (80°F and above) can increase the coefficient of dynamic friction for cable having a nonmetallic jacket.

Pulling lubricants must be compatible with cable components and be applied while the cable is being pulled. Pre-lubrication of the conduit is recommended by some lubricant manufacturers.

⁴Gene C. Neetz, "Coefficient of Friction Measurement Between Cable and Conduit Surfaces Under Varying Loads," in 1985 IEEE Transactions on Power Apparatus and Systems, vol. PAS-104, no. 1, pp. 16-21.

Configuration

The configuration of three single-conductor cables in a conduit is determined by the ratio of the conduit inner diameter (D) to the outer diameter (d) of one of the single cables (D/d ratio).

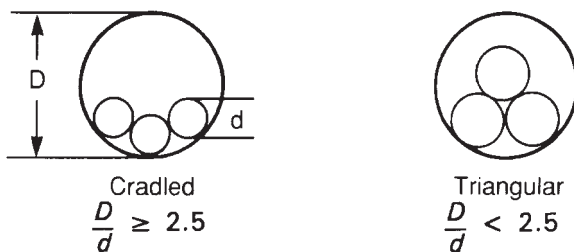

Figure 7-13
Configuration of Three Single Conductors

A cradled configuration develops when three single-conductor cables are pulled into a conduit where the D/d ratio is 2.5 or greater. A triangular configuration develops when three single conductor cables are pulled into a conduit where the D/d ratio is less than 2.5. These cables may be pulled from individual reels, tandem reels, or a single reel with parallel wound cables.

Weight Correction Factor

The configuration of cables can affect cable tension. A weight correction factor (w) is used in the tension equations to account for this effect. The value for the weight correction factor is determined from the equations that follow:

1 cable (single)

$$w = 1 \tag{7-16}$$

3 cables (triangular)

$$w = \frac{1}{\sqrt{1 - \left(\frac{d}{D-d}\right)^2}} \tag{7-17}$$

3 cables (cradles)

$$w = 1 + \frac{4}{3} \cdot \left(\frac{d}{D-d}\right)^2 \tag{7-18}$$

4 cables or more (complex)

$$w = 1.4 \tag{7-19}$$

where: *w* = weight correction factor
D = inner diameter of conduit
d = outside diameter of the cable

Note: When pulling dual cables, use the conservative three-cable (triangular) factor.

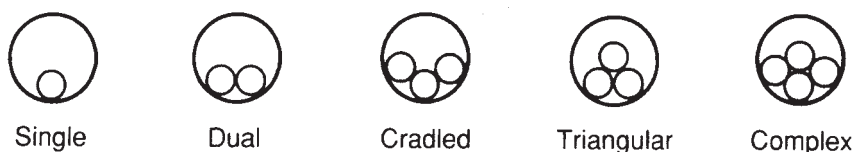

Figure 7-14
Cable Configurations

Sidewall Pressure

Sidewall Pressure (SP) is exerted on a cable as it is pulled around a bend. Excessive sidewall pressure can cause cable damage and is the most restrictive factor in many installations.

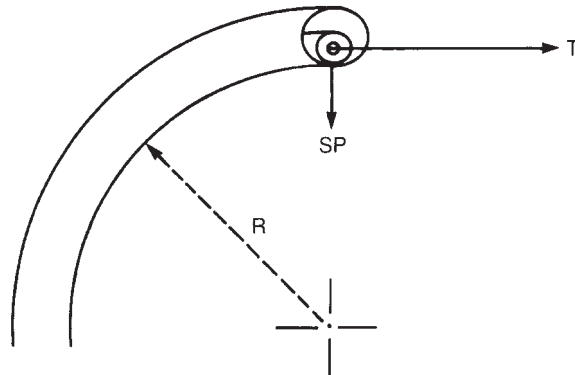

Figure 7-15
Sidewall Pressure Factors

Sidewall pressure is calculated as follows:

For one single-conductor cable or multiple-conductor cable under a common jacket

$$SP = \frac{T}{R} \tag{7-20}$$

For three single-conductor cables, cradled

$$SP = (3w - 2) \cdot \frac{T}{3R} \tag{7-21}$$

For three single-conductor cables, triangular

$$SP = w \cdot \frac{T}{2R} \tag{7-22}$$

where: T = tension coming out of the bend in pounds
(See Table 7-9 for sweep elbows only)

R = bend radius, in feet

w = weight correction factor, dimensionless

SP = sidewall pressure in pounds/foot

Recommended maximum sidewall pressures are provided in Table 7-7 in the range of 300 to 500 pounds per foot, depending on type of cable. The AEIC publication "Underground Extruded Power Cable Pulling Guide" provides maximum sidewall pressures ranging from 1,000 to 2,000 pounds per foot depending on construction. Consult the cable manufacturer prior to using these higher values.

TABLE 7-7

RECOMMENDED MAXIMUM SIDEWALL PRESSURES	
Cable Type	SP lbs/ft
600V 1 kV nonshielded power	500
5-15 kV power	500
25-35 kV power	300
Interlocked armored cable (All Voltage Classes)	300

Clearance

Clearance is the distance between the top of the uppermost cable in the conduit and the inner top surface of the conduit. It should be at least 10% of the conduit inner diameter or one inch for large cables or installations involving numerous bends.

Equations for calculating clearance (CL) are presented as follows:

For single cable

$$CL = D - d \tag{7-23}$$

For three cables, triplexed, triangular

$$CL = \frac{D}{2} - 1.366d + \frac{D-d}{2} \cdot \sqrt{1 - \left(\frac{d}{D-d}\right)^2} \tag{7-24}$$

For three cables, cradles

$$CL = \frac{D}{2} - \frac{d}{2} + \frac{D-d}{2} \cdot \sqrt{1 - \left(\frac{d}{2(D-d)}\right)^2} \tag{7-25}$$

where: D = conduit inner diameter, in inches

d = cable outer diameter, in inches

When calculating clearance, ensure all cable diameters are equal. If in doubt, use the triplexed configuration equation. The cables may be single or multiple-conductor construction.

Jamming

Jamming is the wedging of three or more cables when pulled into a conduit. This usually occurs because of crossovers when the cables twist or are pulled around bends. The jam ratio is the ratio of the conduit inner diameter (D) and the cable outside diameter (d).

$$\text{Jam Ratio} = \frac{D}{d} \tag{7-26}$$

The probability for jamming is presented in Figure 7-16

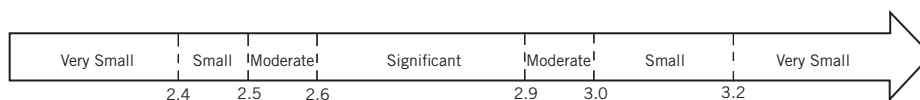

Figure 7-16
Jamming Probabilities Using the Jam Ratio

In calculating jamming probabilities, a 5% factor was used to account for the oval cross-section of conduit bends.

The cable diameters should be measured, since actual diameters may vary from the published nominal values.

Conduit Fill

Conduit fill is the percentage of the area inside the conduit taken up by the cable(s). Consult applicable codes, industry standards, and manufacturers' data for further information on fill. Dimensions and percent area of conduit and tubing are provided in Table 7-8. Dimensions for additional types of conduits can be found in Chapter 9 of the 2005 National Electrical Code.

$$Fill = \left[\frac{d}{D} \right]^2 \cdot N \cdot 100 \text{ percent} \quad (7-27)$$

where: d = outside diameter of the cable in inches

D = inside diameter of the conduit in inches

N = number of cables

**TABLE 7-8
DIMENSIONS AND PERCENT AREA CONDUIT AND TUBING
ELECTRICAL METALLIC TUBING (EMT)**

Trade Size		Internal Diameter		Total Area	2 Wires	Over 2 Wires	1 Wire
Inches	mm	Inches	mm	100% Sq. In.	31% Sq. In.	40% Sq. In.	53% Sq. In.
1/2	16	0.622	15.8	0.304	0.094	0.122	0.161
3/4	21	0.824	20.9	0.533	0.165	0.213	0.283
1	27	1.049	26.6	0.864	0.268	0.346	0.458
1 1/4	35	1.380	35.1	1.496	0.464	0.598	0.793
1 1/2	41	1.610	40.9	2.036	0.631	0.814	1.079
2	53	2.067	52.5	3.356	1.040	1.342	1.778
2 1/2	63	2.731	69.4	5.858	1.816	2.343	3.105
3	78	3.356	85.24	8.846	2.742	3.538	4.688
3 1/2	91	3.834	97.38	11.545	3.579	4.618	6.119
4	103	4.334	110.1	14.753	4.573	5.901	7.819

RIGID PVC CONDUIT SCHEDULE 40 AND HDPE CONDUIT

Trade Size		Internal Diameter		Total Area	2 Wires	Over 2 Wires	1 Wire
Inches		Inches	mm	100% Sq. In.	31% Sq. In.	40% Sq. In.	53% Sq. In.
1/2		0.602	15.3	0.285	0.088	0.114	0.151
3/4		0.804	20.4	0.508	0.157	0.203	0.269
1		1.029	26.1	0.832	0.258	0.333	0.441
1 1/4		1.360	34.5	1.453	0.450	0.581	0.770
1 1/2		1.590	40.4	1.986	0.616	0.794	1.052
2		2.047	51.99	3.291	1.020	1.316	1.744
2 1/2		2.445	62.10	4.695	1.455	1.878	2.488
3		3.042	77.27	7.268	2.253	2.907	3.852
3 1/2		3.521	89.43	9.737	3.018	3.895	5.161
4		3.998	101.5	12.554	3.892	5.022	6.654
5		5.016	127.4	19.761	6.126	7.904	10.473
6		6.031	153.2	28.567	8.856	11.427	15.141

TABLE 7-8 (CONTINUED)

RIGID PVC CONDUIT, SCHEDULE 80						
Trade Size	Internal Diameter		Total Area	2 Wires	Over 2 Wires	1 Wire
Inches	Inches	mm	100% Sq. In.	31% Sq. In.	40% Sq. In.	53% Sq. In.
1/2	0.526	13.4	0.217	0.067	0.087	0.115
3/4	0.722	18.3	0.409	0.127	0.164	0.217
1	0.936	23.8	0.688	0.213	0.275	0.365
1 1/4	1.255	31.88	1.237	0.383	0.495	0.656
1 1/2	1.476	37.49	1.711	0.530	0.684	0.907
2	1.913	48.59	2.874	0.891	1.150	1.1523
2 1/2	2.290	58.71	4.119	1.277	1.647	2.183
3	2.864	72.75	6.442	1.997	2.577	3.414
3 1/2	3.326	84.48	8.688	2.693	3.475	4.605
4	3.786	96.16	11.258	3.490	4.503	5.967
5	4.768	121.1	17.855	5.535	7.142	9.463
6	5.709	145.0	25.598	7.935	10.239	13.567

FLEXIBLE METAL CONDUIT						
Trade Size	Internal Diameter		Total Area	2 Wires	Over 2 Wires	1 Wire
Inches	Inches	mm	100% Sq. In.	31% Sq. In.	40% Sq. In.	53% Sq. In.
3/8	0.384	9.75	0.116	0.036	0.046	0.061
1/2	0.635	16.1	0.317	0.098	0.127	0.168
3/4	0.824	20.9	0.533	0.165	0.213	0.282
1	1.020	25.91	0.817	0.256	0.327	0.433
1 1/4	1.275	32.39	1.277	0.396	0.511	0.677
1 1/2	1.538	39.07	1.857	0.576	0.743	0.984
2	2.040	51.82	3.269	1.013	1.307	1.732
2 1/2	2.500	63.50	4.909	1.522	1.964	2.602
3	3.000	76.20	7.069	2.191	2.827	3.746
3 1/2	3.500	88.90	9.621	2.983	3.848	5.099
4	4.000	101.6	12.566	3.896	5.027	6.660

Calculation Procedure

The following is a recommended procedure for calculating installation parameters for cables in conduit:

- a. Select conduit size based on required fill, clearance, jamming, and applicable codes and standards.
- b. Select values for conduit type, bend radii, and coefficient of friction. Table 7-9 lists the inside radius for manufactured rigid steel conduit sweep elbows.
- c. Determine cable weight (W) from manufacturers' data sheets.
- d. Calculate weight correction factor (w).
- e. Calculate maximum allowable tension.
- f. Calculate pulling tension (T) and sidewall pressure (SP) for each segment.
- g. Compare calculated results to established limits.
- h. If limits are exceeded, consider one or more of the following:
 - 1) Increase bend radii
 - 2) Decrease fill
 - 3) Reduce number of bends
 - 4) Reverse pull
 - 5) Pull in stages
 - 6) Decrease length of pull

TABLE 7-9
SWEEP ELBOW RADIUS

Elbow Centerline Radius (inches)								
	12	15	18	24	30	36	42	48
Conduit Size	Elbow Centerline Radius (feet)							
1	0.96	1.21	1.46	1.96	2.46	2.96	3.46	3.96
1 1/4	0.94	1.19	1.44	1.94	2.44	2.94	3.44	3.94
1 1/2	0.93	1.18	1.43	1.93	2.43	2.93	3.43	3.93
2	0.91	1.16	1.41	1.91	2.41	2.91	3.41	3.91
2 1/2		1.15	1.40	1.90	2.40	2.90	3.40	3.90
3			1.37	1.87	2.37	2.87	3.37	3.87
3 1/2			1.35	1.85	2.35	2.85	3.35	3.85
4				1.83	2.33	2.83	3.33	3.83
5					2.29	2.79	3.29	3.79
6						2.75	3.25	3.75

INSTALLATION IN CABLE TRAY

When pulling cable into cable trays the same approach should be used for cable installed into conduit. Care must be given to the run lengths, number of cable turns, and cable sheave size to ensure the cable's maximum pulling tension, minimum bending radius, and maximum allowable sidewall pressure are not exceeded, subjecting the cable to possible damage.

Rollers and Sheaves

When pulling around bends in cable tray, excessive sidewall pressure can damage the cable. Sidewall pressure can be reduced by using a large radius sheave. Many times, a large radius sheave cannot be used and an assembly of multiple smaller sheaves is used. Care should be given to prevent damage due to high sidewall pressure on the individual sheaves. The individual sheaves should have a minimum inside radius of 1.25 inches with at least one sheave per 20° of the bend. A three-sheave assembly for a 90° bend should never be used.

Rollers and sheaves must be well-maintained and lubricated to achieve the lowest possible coefficient of friction.

Roller Mounting

- Rollers must be properly spaced to prevent the cable from touching the tray.
- Rollers must be free-turning.
- When the tray changes direction, vertically or horizontally, sheave radii must be large enough to meet the minimum bending and maximum allowable sidewall pressure limits.

Roller Spacing

Roller spacing will vary with:

- Cable weight
- Cable tension
- Cable construction
- Roller height above the tray

To estimate roller spacing, the following equation can be used:

$$s = \sqrt{\frac{8hT}{w}} \text{ feet} \quad (7-28)$$

where: s = distance between rollers, in feet

h = height of top roller above the tray bottom, in feet

T = tension, in pounds

w = weight of cable, per foot

The distance will be conservative for armored cable because the equation assumes a perfectly flexible cable. When possible, a length of cable should be used to determine maximum spacing under no tension, as a check for the calculated values.

Pulling Tensions

Calculations of pulling tensions for cable trays are similar to those for pulling cable in conduit, adjusting the coefficient of friction to reflect using rollers and sheaves.

Horizontal Straight Sections

The tension for a horizontal straight section of cable tray can be estimated with the following equation:

$$T_{out} = \mu WL + T_{in} \text{ pounds} \quad (7-29)$$

where: T_{out} = tension out of a section, in pounds

μ = coefficient of dynamic friction ($\mu = 0.15$)

W = total cable assembly weight, in pounds/foot

L = straight section length, in feet

T_{in} = tension into a section, in pounds

The coefficient of friction (μ) equal to 0.15 accounts for the low-rolling friction of well-maintained rollers.

Inclined Straight Sections

Use the following equation for pulling **up** an inclined straight section:

$$T_{out} = WL(\sin\theta + \mu \cos\theta) + T_{in} \text{ pounds} \quad (7-30)$$

Use the following equation for pulling **down** an inclined straight section:

$$T_{out} = -WL(\sin\theta - \mu \cos\theta) + T_{in} \text{ pounds} \quad (7-31)$$

where: T_{out} = tension out of a section, in pounds

W = total cable assembly weight, in pounds/foot

θ = straight section angle from horizontal, in radians

L = straight section length, in feet

μ = coefficient of dynamic friction ($\mu = 0.15$)

T_{in} = tension into a section, in pounds

Vertical Sections

When pulling straight up or down, the equation for inclined pulls simplifies to the following equations:

Pulling Straight Up

$$T_{out} = WL + T_{in} \text{ pounds} \quad (7-32)$$

Pulling Straight Down

$$T_{out} = -WL + T_{in} \text{ pounds} \quad (7-33)$$

where: W = total cable assembly weight, in pounds/foot

L = straight vertical section length, in feet

Tension in Bends

If the sheaves in the bends in cable trays are well-maintained, they will not have the multiplying effect on tension that bends in conduit have. The sheaves will turn with the cable, allowing the coefficient of friction to be assumed zero. This results in the commonly-used approximation for conduit bend equation ($e^{\mu\theta}$), becoming one. Even though cable tray bends produce no multiplying effect, it is essential for heavier cables to include the force required to bend the cable around the sheave. A 200-pound adder per bend should be used for a three-conductor 500 kcmil copper conductor armored cable. If the sheaves are not well-maintained, the bend will have a multiplying effect. The tension in the pull must then be calculated using the same equations used for installations in conduit.

Tension Entering Cable Tray

Because the tension entering the cable tray is rarely zero, it is critical that the tension required to remove the cable from the reel be used to calculate the total tension for

the installation.

Many times it is difficult to know the location of the reel of cable until the cable is being installed. The following equations are used to approximate the tension entering the cable tray and can be used to determine how critical the reel position will be for the cable pull.

Feeding Off Reel Horizontally

When the cable reel can be elevated so that the cable can be pulled directly into the tray, the following equation should be used to approximate the tension required to remove the cable from the reel:

$$T_{reel} = 25W \text{ pound} \quad (7-34)$$

where: T_{reel} = tension, in pounds

W = total cable assembly weight, in pounds/foot

Feeding Off Reel Vertically

When the cable reel must be positioned directly below the cable tray the following equation should be used to approximate the tension required to pull the cable into the tray.

$$T = WL \text{ pounds} \quad (7-35)$$

where: W = total cable assembly weight, in pounds/foot

L = straight vertical section length, in feet

The tension can now be approximated for pulling the cable into the tray from a horizontal position when the reel is placed directly under the tray. To estimate the tension entering the cable tray when the reel must be placed away from and below the entrance to the tray, use the equation for feeding off the reel vertically where the height (L) is the vertical distance between the reel and cable tray. To allow for bending forces as the cable comes off the reel, the minimum tension added should be $25W$.

TYPICAL CALCULATION FOR CABLES IN CONDUIT

Example:

Three THHN single-conductor 4/0 AWG copper

Single-conductor diameter (d) = 0.626 inches

Cable weight (W) = 3×0.711 lbs/ft = 2.13 lbs/ft

Pulling device (T_{device}) = 10,000 pound eye

EMT conduit, trade size 2 inch

Bends 1-2, 3-4, and 5-6 are 90° (1.57 radians)

Use 36-inch sweep elbows (inside radius 2.91 feet)

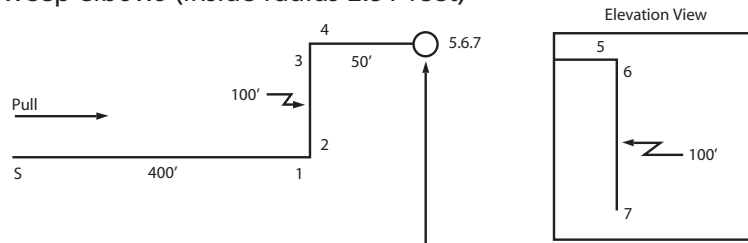

Figure 7-17
Conduit Layout

1. Select conduit size based on required fill, clearance, jamming, and applicable codes and standards.

a) EMT trade size 2 inch: $D = 2.067$ inches from Table 7-4

b) Conduit fill, using equation (E-27):

$$Fill = \left[\frac{d}{D} \right]^2 \cdot N \cdot 100 \text{ percent}$$

$$Fill = \left[\frac{0.626}{2.067} \right]^2 \cdot 3 \cdot 100 \text{ percent}$$

$$Fill = 27.5\%$$

Within limits, if we assume 40% fill as the maximum specification requirements.

c) Configuration, jamming, clearance

First determine **configuration** (See Figure 7-13)

$$\frac{D}{d} = \frac{2.067}{0.626} = 3.3$$

Because:

$$\frac{D}{d} = \text{is greater than } 2.5$$

Configuration will be cradled.

Jamming can now be evaluated using equation (7-25)

$$\frac{D}{d} = 3.3$$

Jamming is acceptable because the probability for jamming is very small since:

$$\frac{D}{d} \text{ is greater than } 3.2$$

Clearance can be determined using equation (7-22)

$$CL = \frac{D}{2} - \frac{d}{2} + \frac{D-d}{2} \cdot \sqrt{1 - \left[\frac{d}{2(D-d)} \right]^2}$$

$$CL = \frac{2.067}{2} - \frac{0.626}{2} + \frac{2.067 - 0.626}{2} \cdot \sqrt{1 - \left[\frac{0.626}{2(2.067 - 0.626)} \right]^2}$$

$$CL = 1.424 \text{ inches}$$

Clearance is acceptable because clearance is significantly greater than 10% of the conduit inside diameter, and is also greater than 1 inch.

2. Select values for conduit type, bend radii, and coefficient of friction.

EMT conduit, trade size 2 inch from Table 7-8

All bends are 90° (= 1.57 radians)

36-inch sweep elbow from Table 7-9

Bend radii = 2.91 feet

Coefficient of friction (μ) = 0.4 from Table 7-6

3. Calculate weight correction factor (w) using equation (7-18), three cables, cradled.

$$w = 1 + \frac{4}{3} \cdot \left(\frac{d}{D-d} \right)^2$$

$$w = 1 + \frac{4}{3} \cdot \left(\frac{0.626}{2.067 - 0.626} \right)^2$$

$$w = 1.25$$

4. Calculate maximum allowable tension (T_m) using equations (7-4) and (7-5):

$$T_c = S \cdot A = (0.008) \cdot (211,600) = 1,693 \text{ pounds}$$

$$T_{cable} = N \cdot T_c = (3) \cdot (1,693) = 5,079 \text{ pounds}$$

$$T_{device} = 10,000 \text{ pounds}$$

Because T_{cable} is less than T_{device}

$$T_m = T_{cable} = 5,079 \text{ pounds}$$

5. Calculate pulling tension for each segment of the cable run.

- a) Tension at point S, assuming no reel drag.

$$T_s = T_{in} \approx 0 \text{ pounds}$$

- b) Segment S to 1

For horizontal straight section using equation (7-7), calculate tension T_{out} at point 1.

$$T_{out} = w\mu WL + T_{in}$$

$$T_{out} = (1.25) \cdot (0.4) \cdot (2.13) \cdot (400) + 0$$

$$T_{out} = 426 \text{ pounds}$$

Within limits, below 5,079 lbs. (T_m)

c) Segment 1 to 2

For horizontal bend section using approximate equation (7-18), calculate tension T_{out} at point 2.

$$T_{out} = T_{in} \cdot e^{w\mu\phi}$$

$$T_{out} = (426) \cdot e^{[(1.25) \cdot (0.4) \cdot (1.57)]}$$

$$T_{out} = 934 \text{ pounds}$$

Within limits, below 5,079 lbs. (T_m)

d) Segment 2 to 3

For horizontal straight section using equation (7-7), calculate tension T_{out} at point 3.

$$T_{out} = wuWL + T_{in}$$

$$T_{out} = (1.25) \cdot (0.4) \cdot (2.13) \cdot (100) + 934$$

$$T_{out} = 1,041 \text{ pounds}$$

Within limits, below 5,079 lbs. (T_m)

e) Segment 3 to 4

For horizontal bend section using approximate equation (7-15), calculate tension T_{out} at point 4.

$$T_{out} = T_{in} \cdot e^{w\mu\phi}$$

$$T_{out} = (1,041) \cdot e^{[(1.25) \cdot (0.4) \cdot (1.57)]}$$

$$T_{out} = 2,282 \text{ pounds}$$

Within limits, below 5,079 lbs. (T_m)

f) Segment 4 to 5

For horizontal straight section using equation (7-7), calculate tension T_{out} at point 5.

$$T_{out} = w\mu WL + T_{in}$$

$$T_{out} = (1.25) \cdot (0.4) \cdot (2.13) \cdot (50) + 2,282$$

$$T_{out} = 2,335 \text{ pounds}$$

Within limits, below 5,079 lbs. (T_m)

g) Segment 5 to 6

Vertical concave downbend using approximate equation (7-15), calculate tension T_{out} at point 6.

$$T_{out} = T_{in} \cdot e^{w\mu\phi}$$

$$T_{out} = (2,335) \cdot e^{[(1.25) \cdot (0.4) \cdot (1.57)]}$$

$$T_{out} = 5,119 \text{ pounds}$$

CAUTION:

Probably acceptable even through slightly above 5,079 lbs. (T_m)

h) Segment 6 to 7

Pulling down vertical straight section using equation (7-9),
calculate tension T_{out} at point 7.

$$T_{out} = -WL(\sin\theta - w\mu \cos\theta) + T_{in}$$

$$T_{out} = -(2.13) \cdot (100) \cdot [(1) - (1.25) \cdot (0.4) \cdot (0)] + 5,119$$

$$T_{out} = 4,906 \text{ pounds}$$

Within limits, below 5,078 lbs. (T_m)—**caution is advised.**

6. Calculate sidewall pressures (SP) at each bend of the pull for cradled configuration (E-18) and a maximum value of 500 pounds per foot from Table 7-7.

a) Segment 1 to 2

$$SP = (3w - 2) \cdot \frac{T}{3R}$$

$$SP = [(3 \cdot 1.25) - 2] \cdot \left[\frac{934}{3 \cdot 2.91} \right]$$

$$SP = 187 \text{ pounds/ft}$$

Within limits, less than 500 pounds per foot.

b) Segment 3 to 4

$$SP = [(3 \cdot 1.25) - 2] \cdot \left[\frac{2,282}{3 \cdot 2.91} \right]$$

$$SP = 457 \text{ pounds/ft}$$

Within limits.

c) Segment 5 to 6

$$SP = [(3 \cdot 1.25) - 2] \cdot \left[\frac{5,119}{3 \cdot 2.91} \right]$$

$$SP = 1,026 \text{ pounds/ft}$$

Exceeds limits. Not Acceptable: For possible solutions, refer to page 7-19, Calculation Procedure section.

CABLES BURIED DIRECTLY IN EARTH

The NEC, NESC, and IEEE provide basic information regarding direct burial of electrical cables.⁵

Depth of Burial

1. The depth of burial shall be sufficient to protect the cable from damage imposed by expected surface usage.
2. Burial depths as indicated in Table 7-6 are considered adequate for supply cables or conductors, except as noted in a, b, or c.

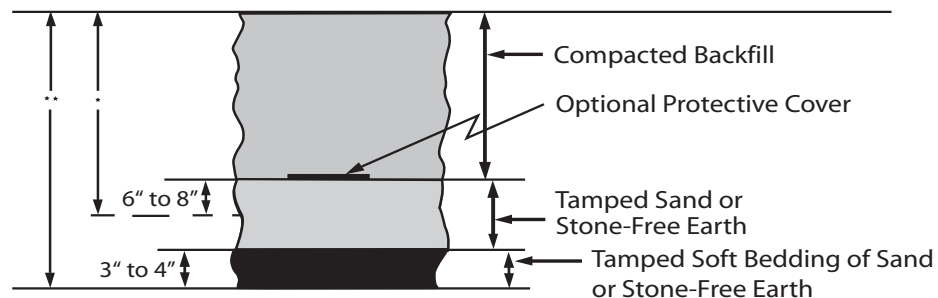

Figure 7-18
Typical Burial Cross-Section

TABLE 7-10

NESC TABLE 352-1 SUPPLY CABLE OR CONDUCTOR BURIAL DEPTH		
Voltage Phase to Phase	Depth of Burial	
	(in)	(mm)
0 to 600	24	600
601 to 50,000	30	750
50,001 and above	42	1070

EXCEPTION: Street light cables operating at not more than 150 V to ground may be buried at a depth not less than 18 in. (450mm).

- a. In area where frost conditions could damage cables, burial depths should be greater.
- b. Lesser depths may be used where supplemental protection is provided. The supplemental protection should be sufficient to protect the cable from damage imposed by expected surface usage.
- c. Where the surface is not to final grade, the cable should be placed to meet or exceed the requirements indicated above, both at the time of installation and when the surface is to final grade.

Trenching

The bottom of the trench should be smooth, undisturbed, well-tamped earth or sand. When excavation is in rock or rocky soils, the cable should be laid on a protective layer of well-tamped backfill. Backfill within 4 inches of the cable should be free of materials that may damage the cable. Backfill should be adequately compacted. Machine compaction should not be used within 6 inches of the cable.

A protective covering above the cable will warn excavators of the presence of an underlying cable.

⁵NEC, section 300.5; National Electrical Safety Code (NESC), 2002 edition, section 35; ANSI C2-2002, Secretariat IEEE."

Plowing

Plowing of cable should not result in damage to the cable from rocks or other solid materials. The design of cable plowing equipment and the plowing of cable should not damage the cable by exceeding bend, sidewall pressure, cable tension, or other allowable limits.

Supplemental Information

A jacketed multiconductor is preferable to the installation of single-conductor cables to ease installation and avoid crossovers.

Under vehicular and pedestrian traffic ways, it is good practice to pull cable through a conduit.

AERIAL INSTALLATION

Sag and Tension

This information is intended for initial design information only. The cable manufacturer can supply detailed data, which include thermal expansion and creep. These factors increase the arc length after initial stringing, resulting in an increased sag.

The calculation for sag and tension is based on the equation for parabolas. This equation closely approximates a catenary curve for small deflections, as given by:

$$T_H = \frac{s^2 w}{8d} \text{ pounds} \quad (7-36)$$

where: T_H = horizontal tension in conductor or messenger, in pounds

s = length of span between supports, in feet

w = weight of cable assembly, includes supporting conductor/messenger, saddles, lashings, etc., in pounds per foot

d = sag, in feet

The total messenger tension, at its support, consists of a horizontal and a vertical component. The vertical component has been neglected.

The tension shall not exceed:

- a) 50% of rated breaking strength of the messenger under the assumed ice and wind loading
- b) 25% of rated breaking strength for final unloaded tension at 60°F (15°C)

Ice and Wind Loading

Ice and wind loading on aboveground cables and conductors are determined by location. The NESC divides the United States into three loading districts—Light, Medium, and Heavy.

The weight of the ice, force of the wind, and resultant weight of the cable can be calculated by the following equations.⁶

$$i = (1.24) \cdot (t) \cdot (D + t) \quad (7-37)$$

$$h = \frac{P(D + 2t)}{12} \quad (7-38)$$

$$W_L = \sqrt{(w + i)^2 + h^2} + K \quad (7-39)$$

where: i = weight of ice, in pounds per foot

t = thickness of ice, in inches

D = outside diameter of cable, in inches

h = force of wind, in pounds per foot

P = horizontal wind pressure, in pounds per square foot

W_L = resultant weight of loaded cable, in pounds per foot

W = weight of cable only (i.e. without ice), in pounds per foot

K = constant from NESC Table 251-1

Values of t , P , and K are presented in Table 7-11. This information is extracted from Tables 250-1 and 251-1 of the NESC.

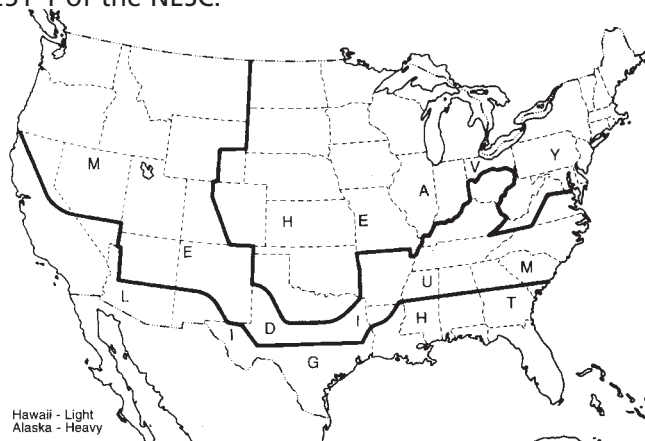

Figure 7-19
NESC Loading District Boundaries

⁶Archer E. Knowlton, ed. Standard Handbook for Electrical Engineers, 8th edition (McGraw-Hill, 1949).

TABLE 7-11

LOADING DISTRICT VARIABLES			
Variables	Loading District*		
	Heavy	Medium	Light
t, radial thickness of ice (in)	0.50	0.25	0
**P, horizontal wind pressure (Pa)	4	4	9
K, a constant (lb/ft)	0.30	0.20	0.05
Temperature (°F)	0	15	30

*Figure 7-19 presents Loading District boundaries.

** For horizontal wind velocity of 70 mph and above, refer to NESC Table 250-2.

Additional Information

Additional information can be found in ICEA Publication P-79-561 "Guide for Selecting Aerial Cable Messengers and Lashing Wires."⁷

Typical breaking strengths of messengers are presented in the following table:

TABLE 7-12

MESSENGER CHARACTERISTICS			
Nominal Messenger Size (inch)	Number of Strands	EHS Galvanized Steel	
		Weight (lb/ft)	Breaking Strength (lbs)
1/4	7	0.121	6,650
5/16	7	0.205	11,200
3/8	7	0.273	15,400
7/16	7	0.399	20,800
1/2	7	0.512	26,900
9/16	7	0.671	35,000
9/16	19	0.637	33,700

CABLES UNDER VERTICAL TENSION

ICEA Support Requirements

ICEA suggests that for supported vertical installations, such as vertical shafts or risers and bore holes, the supporting member may be the conductor(s) or the armor wires in wire armored cables.⁸ Strength requirements are expressed in terms of a minimum safety factor (F_s), which is the ratio of rated cable strength to supported cable weight. The equation is:

$$F_s = \frac{NAT}{W\ell} \quad (7-40)$$

where: F_s = safety factor, per Table 7-9

N = number of conductors

A = cross-sectional area of one conductor or one armor wire, in square inches

T = tensile stress allowed on supporting member from Table 14, in psi

W = weight of cable, in pounds/foot

ℓ = length of cable, in feet

⁷ ICEA P-79-561-1985, "Guide for Selecting Aerial Cable Messengers and Lashing Wires."

⁸ ICEA S-95-658 (NEMA WC70-1999) "Nonshielded Power Cables Rated 2000 Volts or Less For The Distribution of Electrical Energy" and ICEA S-93-639 (NEMA WC 74-2000): "5 - 46 kV Shielded Power Cable for Use in the Transmission & Distribution of Electric Energy."

TABLE 7-13

SAFETY FACTOR FOR CABLES UNDER VERTICAL TENSION	
Cable Type	Safety Factor F_s
Unarmored	7
Armored Riser & Shaft	7
Armored Borehole	5

TABLE 7-14

MAXIMUM STRESS ALLOWED ON SUPPORTING MEMBERS	
Materials	Tensile Stress, (T) psi
Annealed Copper	24,000
Medium Hard Copper	40,000
Aluminum 1350	17,000
Armor Wire, Galvanized Steel	50,000

Support can be achieved by cable clamps that will not damage cable components. The spacing (S) of clamps can be determined by using the following equation which results in an approximate value.

$$S = \frac{9DL}{W} \text{ feet} \quad (7-41)$$

where: D = outer diameter of cable in inches

L = length of clamp along cable axis in inches

W = weight of cable in pounds/foot

NEC Support Requirements

The NEC defines support in vertical raceways—one vertical support at the top, or as close as practical, plus a support for each spacing interval as defined in Table 7-15.

TABLE 7-15

NEC TABLE 300.19 (A) SPACING FOR CONDUCTOR SUPPORTS*			
Size of Wire AWG or kcmil	Support of Conductors in Vertical	Aluminum or Copper-Clad Aluminum	Copper
18 AWG through 8 AWG	Not Greater Than	100 feet	100 feet
6 AWG through 1/0 AWG	Not Greater Than	200 feet	100 feet
2/0 AWG through 4/0 AWG	Not Greater Than	180 feet	80 feet
Over 4/0 AWG through 350 kcmil	Not Greater Than	135 feet	60 feet
Over 350 kcmil through 500 kcmil	Not Greater Than	120 feet	50 feet
Over 500 kcmil through 750 kcmil	Not Greater Than	95 feet	40 feet
Over 750 kcmil	Not Greater Than	85 feet	35 feet

* Reprinted with permission from NFPA 70-2-5, the National Electric Code®, Copyright 2005, National Fire Protection Association, Quincy, MA 02269. This reprinted material is not the complete and official position of the National Fire Protection Association on the referenced subject which is represented only in the standard in its entirety.

FIELD REMOVAL OF MOISTURE FROM POWER CABLES

Normally, cable ends are sealed until the cable is installed to prevent moisture from entering the cable. When open cable ends are submerged or exposed, water can migrate inside the cable. If water remains in a medium-voltage cable, it can accelerate insulation deterioration and lead to premature failure.

You can remove water from wet cable by purging the cable with dry nitrogen gas under pressure. Any wire or cable product that does not contain fillers and is suitable for wet locations, can be purged under engineering supervision.

If you do have to purge a length of wire or cable, always test it before you energize it. At a minimum, conduct an insulation resistance test with a megohm-meter.

NOTE: The purging procedures described here assume the water in the wire or cable does **not** contain unusually high concentrations of oils or chemicals, such as may be found in floodwaters. If you suspect that water inside a cable carries unusual contaminants, consult the manufacturer before deciding to continue using the wire or cable. If you are not certain about the source of water in cable, water samples from the cable, the work site, and the manufacturer can be analyzed for mineral content. Comparing mineral contents can, many times, identify the source of the water.

Required Materials

The medium for purging moisture from cable is dry nitrogen gas, available at most welding supply houses. You will need:

1. A cylinder of dry nitrogen gas with a dew point of -60°C .
2. A regulator to reduce the gas pressure to approximately 15 psi.
3. Some 1/4" gas hose—and some hose clamps—to run between the tank and the cable end.
4. A hose nipple to connect the hose to the regulator.
5. A cable cap that fits the cable end and a radiator hose clamp that fits the end cap.
6. An automobile tire valve stem assembly—with no valve core installed—to connect the hose to the cable cap.
7. Plastic bags to enclose gas-exit end of the cable. One-gallon bags are a good size.
8. Color indicating desiccant: anhydrous cupric sulfate or Silica Gel desiccant. Cupric sulfate is available from laboratory supply houses. These desiccants absorb water and change color—to either off-white or pink—when exposed to moisture.

General Purging Process

The purging setup is shown in Figure 7-20. To purge several cables at once, connect them to the gas supply with a manifold, as shown in Figure 7-21. If only one end of the cable contains water, apply purging gas to the dry end. If the whole cable is wet, apply purging gas to the higher end.

Always purge the cable shield separately from the insulated strands. If you try to do them at the same time, the gas will flow only through the path offering the least resistance.

Before purging installed cables, remove cable terminations and splices. Do not try to purge across or through splices.

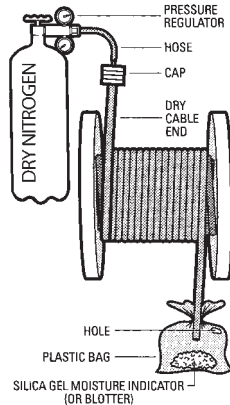

Figure 7-20
Cable Purging Setup

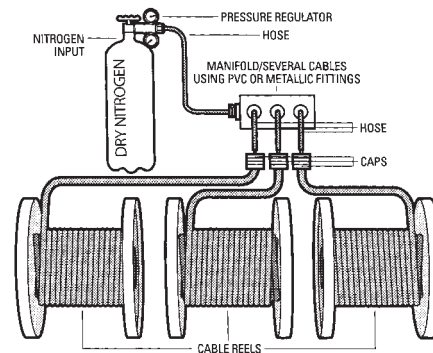

Figure 7-21
Multiple Cable Purging Setup

Purging Cable Conductors

1. Select an end cap that fits over the cable core.
2. Cut a hole in the end cap for the valve stem and install the valve stem.
3. At the dry (or higher) cable end, apply two layers of half-lapped high voltage insulating tape as a sealing cushion for the end cap.
4. Install the end cap on the cable using the radiator hose clamp.
5. Connect the low pressure side of the nitrogen regulator to the end cap with the gas hose.
6. Turn on the nitrogen and adjust the regulator to 15 psi.
7. If water is not running or dripping out of the open cable end, sprinkle a tablespoon of color-indicating desiccant into a plastic bag and tape or clamp the bag to the open cable end.
8. Check to make sure the bag is filling with nitrogen. If it is, make a small vent hole by clipping off one corner of the bag.
9. After a few hours, check the desiccant to see if it has changed from the blue to off-white or pink. This indicates moisture coming out of the cable. If the desiccant has changed color, replace it with fresh desiccant and continue purging. (You can also check for moisture by holding a piece of tissue or blotter paper next to the vent hole for a few minutes. If the paper gets damp, moisture is still coming out of the cable.)
10. Change the desiccant every few hours until it stops changing color. When you have gone several hours with no sign of moisture, you can assume the cable is dry. Depending on how much moisture is in the cable, purging may take up to eight hours—occasionally even longer. One cylinder of nitrogen should be enough for at least one cable run.

You can also drive water vapor from conductor strands by lightly loading the cable with low voltage and low current. This process does **not** dry out the shield assembly. The cable terminations must have an open strand design or terminations must be removed to let the water vapor escape.

Purging Cable Shield

You can purge cable shield systems by following the conductor purging process with the following exceptions: (1) block the conductor strands so no gas can pass through them, and (2) place end caps over the jacket rather than the cable core. Apply gas pressure and check for moisture as before. Do not exceed 15 psi maximum.

Cable on Reels

You will have to unlash the cable ends to connect the purging set-up to cables on reels. If you find water in only one end of a reel of cable, position the reel so the wet end is in its lowest possible elevation. If you see moisture at both ends of the cable, position the inside end of the cable as low as possible and purge from the outer end of the cable.

DESIGN AND INSTALLATION OF CABLE ACCESSORIES

NOTE: IEEE Standard 404 distinguishes a splice and a joint differently from the way these terms appear in this text.¹ The common phraseology in the industry today is to refer to the connection of two pieces of cable in the field as a splice. We have therefore chosen to use the term “splice” in this manual.

GENERAL

The foundation for understanding the principals of cable accessories is dependent upon understanding the “Basics of Insulated Power Cable Construction” presented in Chapter 1 of this manual.

CABLE ACCESSORIES

Cable accessories included in this section are limited to terminations and splices of shielded and nonshielded cable systems for extruded dielectric cables through 35kV.

Design Concepts

The following items are basic to all methods of terminating or splicing power cables, shielded or nonshielded.

The compatibility of the accessory is dependent on matching the cable’s electrical, chemical, and physical characteristics as closely as possible. A terminal or splice connector should maintain the resistive and thermal capability of the cable conductor. The insulation materials employed should be chemically and physically compatible with the cable materials.

Construction of an accessory is actually a systematic destruction of the cable cross-section and a systematic reconstruction of a dielectric system to maintain cable circuit continuity with an acceptable level of service reliability. A strict adherence to design, construction principals, specified installation procedures, and cleanliness of the cable and accessory materials is required during installation of the accessory.

¹ IEEE Standard 404-2000, “IEEE Standard for Extruded and Laminated Dielectric Shielded Cable Joints Rated 2,500V through 500,000V.”

Basis of Electrical Design

Design must embody both theoretical and practical considerations. The theoretical considerations are those primarily of dielectric stress control. The practical considerations are those associated with environmental conditions such as mechanics of assembly, ambient conditions, and economics.

Dielectric Stress Control

Dielectric stresses within a cable and its accessories must be held within tolerable limits. Stresses are influenced by the characteristics of the dielectrics employed and are generally classified as follows:

Cable

Due to its generally uniform construction, radial stresses are the prime consideration in the cable.

Accessory

Although equipotential and electrostatic lines within a cable and an accessory are similar (except for magnitude), the stresses in an accessory are more complex than in a cable. In addition to radial stresses, contour changes in the components of an accessory produce stresses that are radial, longitudinal, and tangential. These stresses are more critical in accessories associated with shielded cables.

Environmental Conditions

The environment and cable operating conditions have an effect on the design of a cable accessory. Direct burial or duct installation, ambient temperature, and corrosive environment are some of the factors that will have an effect. Also, because the accessory is installed in the field under less than ideal conditions, it is very important that the installers be proficient in their craft.

Characteristics of Components

Conductor connections should prevent the possibility of thermal and physical damage of the accessory and cable insulation during its operating life.

The geometry of the accessory insulation and its interface with the cable insulation must prevent partial discharge at operating voltages and safely withstand the stresses to which it is subjected.

The resistivity of shield materials must be adequate to conduct the electrostatically induced voltages, charging currents, and leakage currents to ground.

Electromagnetically induced currents and fault currents must be safely handled across the splice area.

The outer protective cover of a splice must provide physical strength and rigidity, protection against moisture entry into the splice dielectric, and resistance to attack by other environmental contaminants.

The outer covering of a termination must resist electrical tracking, provide protection to the cable insulation from ultraviolet attack, and prevent moisture entry into the cable system.

Design Testing

An indication of service performance can be obtained by subjecting specific designs to selected test levels. The materials used in these designs are also subjected to certain tests to determine their suitability for design incorporation.

Engineering economics preclude testing of all designs for field installation. Reliable results are attained by subjecting specific designs to selected tests to determine operating criteria. The testing of accessory design is an area of study by itself.

Terminations of Nonshielded Cables

Terminations of nonshielded cable are not complex. Primary considerations are compatibility of connectors with the conductor material and any added insulating material with existing cable insulation.

Terminations of Shielded Cables

Terminating shielded cables is more complex than terminating nonshielded cables. Shielded cable terminations require closer attention to details.

Design

In addition to the compatibility of the connector with the conductor and insulating materials with the existing insulation, the electrical function of the various materials used in making the termination must be considered.

Flashover

Flashover is an electrical arc that can occur between the exposed insulation shield and the exposed cable conductor. To prevent flashover, the insulation shield must be removed for a specified distance.

Dielectric Voltage Stresses

As discussed in Chapter 1, the dielectric field in a shielded power cable is symmetrical. No abnormal voltage stresses in the insulation are present as long as the cable components remain intact. When terminating a cable, it becomes necessary to disrupt these components. As stated above, the insulation shield must be removed for a specified distance to prevent flashover. Removal of this shield results in severe distortion of the dielectric field. This distortion creates abnormally high voltage stresses in the insulation at the edge of the insulation shield (see Fig. 8-1). These stresses must be relieved in order to prevent cable terminal failure.

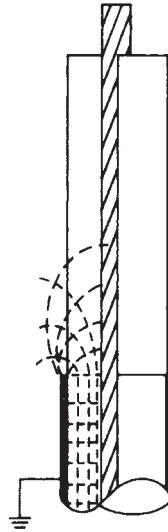

Fig. 8-1
Dielectric Field - No Stress Relief

Stress Relief

Stress relief is the common term applied to the control or relief of the high voltage stresses in the insulation at the edge of the insulation shield. Stress relief can be achieved by either of two methods:

- a. The classical method is the use of a receding ground plane (see Fig. 8-2). The receding ground plane is commonly supported by a cone of insulating material that is compatible with the cable insulation. The conical shape of the receding ground plane gives rise to the term "stress relief cone."

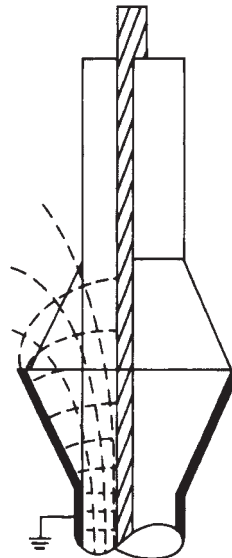

Fig. 8-2
Dielectric Field - Receding Ground Plane - Stress Relief Cone

- b. Another method with proven reliability is the use of a material that controls the voltage gradient at the edge of the insulation shield (see Fig. 8-3). This method does not require the use of a stress cone and results in a termination with a slender profile.

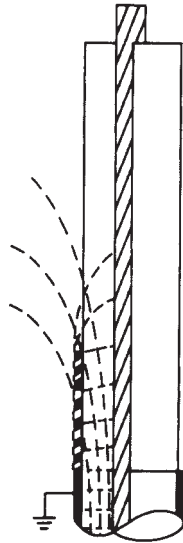

Fig. 8-3
Dielectric Field-Voltage Gradient (Material)-Stress Relief

In the preceding figures, the representations of the dielectric fields neglect the differences between the dielectric constants of the cable dielectric, the stress relief materials, and the surrounding air.

Materials

Upon establishing the design requirements for terminations, it is necessary to determine the materials to be used that will result in meeting the design requirements.

Terminal Connector

The connector to be installed on the conductor must be compatible with the conductor. Connectors for use only with copper conductors should be marked CU. SOL or STR markings indicate use with solid or stranded conductors, respectively. Connectors for use only with aluminum should be marked AL and either SOL or STR. Connectors for use with either copper or aluminum conductors are marked AL-CU or CU-AL and either SOL or STR. All terminal connectors may be either compression, solder-sweat, or mechanical types.

Conductor Shield

In a termination, the conductor shield cable component loses its functional significance and requires no special treatment other than removal for installing the connector.

Insulation

The important consideration for the cable insulation is a control of the voltage stresses in the insulation at the edge of the insulation shield.

In the receding ground plane method of stress relief, an insulating base for the receding ground plane is applied over the exposed cable insulation. This field-applied insulation must be compatible with the cable insulation. It may be a butyl rubber, polyethylene, or an ethylene-propylene rubber based compound.

Similarly, the materials used in the voltage gradient material method of stress relief must be compatible with the cable insulation.

Insulation Shield

The treatment of the edge of the cable insulation shield is critical to the successful function of the termination.

In the receding ground plane method, the receding ground plane is an extension of the cable insulation shield.

The resistivity of the material used must be adequate to function as an extension of the cable insulation shield. It is usually a polymer having a butyl rubber or ethylene propylene rubber base. Additionally, the applied conducting polymer must be compatible with the cable insulation, the cable insulation shield, and the insulating material applied over the cable insulation to support the receding ground plane.

Jacket or Outer Covering

For outdoor or contaminated areas, it is absolutely necessary to seal the cable conductor to prevent entry of water and to provide a track resistant covering over the termination. This requirement is considered good practice for other areas.

Performance Requirements

After the termination design is determined and the proper selection of materials is made, the termination must be tested to establish its functional reliability.

Design tests should be performed by the manufacturer. These tests must meet or exceed the requirements of IEEE Standard No.48².

Splices of Nonshielded Cables

As with terminations, splices of nonshielded cables are not complex. Primary considerations are compatibility of connectors with the conductor material and any added insulating material with the existing cable insulation.

Splices of Shielded Cables

The basic concept to be remembered in splicing two cables is that the cable splice is in fact a short piece of cable that is fabricated in the field. As such, the splice must have the same components as the cables.

Design

For shielded cables, the splice design must take into consideration not only compatibility of materials, but also the continuation of each cable component in order to keep abnormal voltage stresses to a minimum.

² IEEE Standard 48-2003. "Standard for Test Procedures and Requirements for Alternating Current Cable Terminations 2.5kV through 765kV.

Dielectric Voltage Stresses

The cable components must be disrupted to make a splice. The splice results in a distortion of the dielectric field, producing nonsymmetrical voltage stresses in the insulation. The design of the splice will control these voltage stresses and should prevent splice failure. The dielectric voltage stresses in splices are radial, tangential, and longitudinal (see Fig. 8-4 and 8-5).

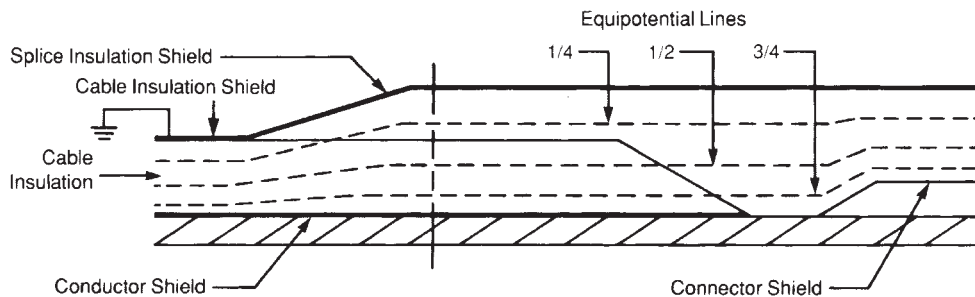

Fig. 8-4
Dielectric Field-Equipotential Lines-Tape Type Splice

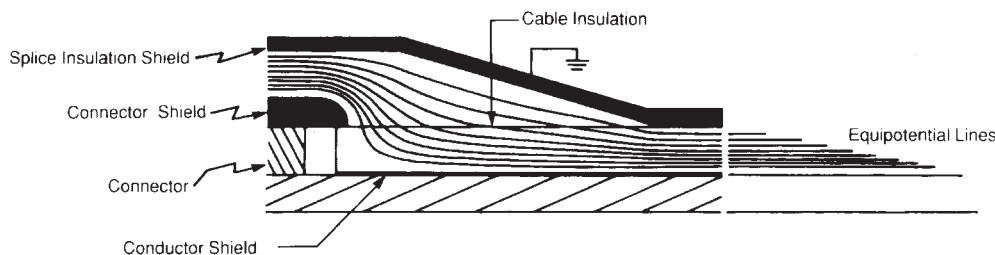

Fig. 8-5
Dielectric Field-Equipotential Lines-Premolded Splice

In the preceding figures, the representations of the dielectric fields neglect the differences between the dielectric constants of the cable dielectric and the splice materials.

Radial Voltage Stresses

Radial stresses were defined earlier and exist throughout the splice. Of primary concern are the maximum radial stresses that occur at the areas of minimum diameters at the cable conductor shield and the shield applied over the connector.

Tangential Voltage Stresses

Tangential stresses occur because of a change in the dielectric field due to a change in the geometry of the components. The areas of critical tangential stresses are at the base of the cable insulation where the insulation was penciled, the shoulder of the connector shield for tape splices, and at the base of the applied splice insulation belt taper for both tape and premolded splices.

Longitudinal Voltage Stresses

Longitudinal stresses exist along the interface of the cable insulation and the applied splice insulation material.

A properly designed splice takes into consideration all the above voltage stresses.

Materials

Upon establishing the design requirements for splices, it is necessary to determine the materials to be used that will result in meeting the design requirements. Additionally, the materials must be compatible with the cable components as they relate to the function of the splice.

Conductor Connector

The splice connector must be compatible with the conductor as previously outlined for terminations. Also, the contour of the splice connector must be smooth and preferably with tapered ends for tape-type splices.

Connector Shield

The resistivity of the material applied over the connector and exposed cable conductor must remain stable throughout the temperature range of the conductor and connector. This material is usually a polymer having a butyl rubber or ethylene-propylene rubber base. Additionally, the material must be compatible with the cable conductor, connector, cable conductor shield, cable insulation, and the insulation applied to insulate the splice.

Insulation

The insulation applied over the conductor shield must be highly compatible with the cable insulation and capable of interfacing with the cable insulation in a manner that will prevent failure along the interface.

The thickness of the applied insulation must be sufficient to prevent insulation failure and still not impose a thermal limit on the cable being spliced. This material may be a polymer with a butyl rubber, polyethylene, or ethylene-propylene rubber base.

Insulation Shield

The resistivity of the material applied over the splice insulation, the cable insulation, and the cable insulation shield must remain stable throughout the temperature range of the splice. Additionally, the material must be compatible with the splice insulation, cable insulation, and cable insulation shield. The material is usually a polymer having a butyl rubber or ethylene-propylene rubber base. In most applications, a metallic tape or braid is applied over the polymeric material to provide adequate conductance to keep the shield at a safe potential.

Jacket or Outer Covering

A jacket or outer covering of appropriate material should be applied for environmental protection.

Performance Requirements

After the splice design is determined and the proper selection of materials is made, the splice must be tested to establish its functional reliability.

Design tests should be performed by the manufacturer. These tests must meet or exceed the requirements of IEEE Standards 404 and 592.³

³ IEEE Standard 404-2000, "Standard for Extruded and Laminated Dielectric Shielded Cable Joints Rated 2,500V through 500,000V and "IEEE 592-1996 "Standard for Exposed Semiconducting Shields on High voltage Cable Joints and Separate Insulated Conductors."

FIELD INSTALLATION

Good installation practices include cleanliness, cable and preparation, conductor connections, dielectric system application, and personnel qualification. It is of prime importance that the installer explicitly adhere to the installation instructions and good installation practices.

Cable Component Identification

To assist in the field reconstruction of a short length of cable, it is appropriate to identify the components of typical cables.

Nonshielded Cable

Components identified in Fig. 8-6 can be related to Fig. 1-1 in Chapter 1.

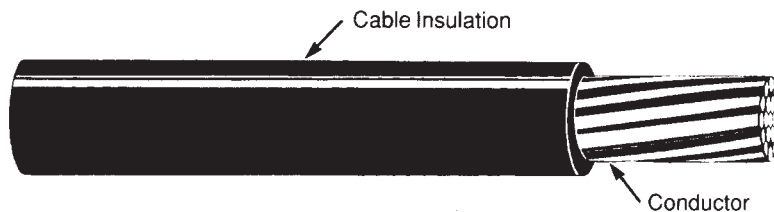

Fig. 8-6
Nonshielded Cable

Some nonshielded cables may have a jacket that is not integral to the cable dielectric.

Shielded Cable

Components identified in Figs. 8-7 and 8-8 can be related to Chapter 1.

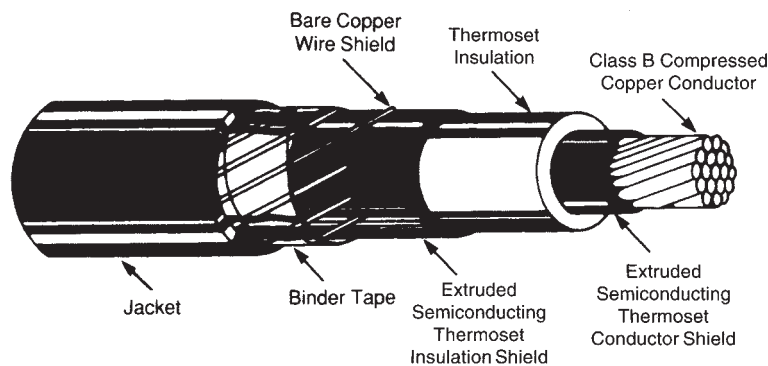

Fig. 8-7
Shielded Cable - Wire Primary Shield

Observe the additional components in comparison to the nonshielded cable. The metallic shielding may be tape instead of wire.

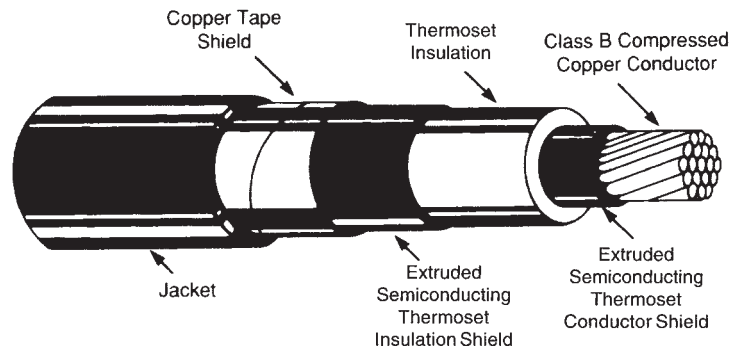

Fig. 8-8
Shielded Cable - Metal Tape Primary Shield

This cable has a metal tape as the primary shield, while the cable in Fig. 8-7 has wires as the primary shield. Both cables have an extruded semiconducting layer as an auxiliary shield.

Cleanliness

The manufacture of cable within the factory is in accordance with high standards of cleanliness to meet electrical insulation requirements. The field reconstruction of the cable for a termination or a splice installation must follow the same principles. Cleanliness of materials, tools, and immediate work area will minimize contamination possibilities of the termination and splice installation.

Cable End Preparation

The foundation of a good termination or splice is proper cable end preparation. Cable ends should be straight and squarely cut. If insulation pencils are required, they should be made to the proper length. All exposed cable insulation should be smooth and free of nicks, gouges, and contaminants.

Construction drawings and instructions should be available for on-site reference by the installer. These instructions are typified by the following procedural steps.

Removal of Protective Jacket

The protective jacket should be removed to expose the underlying primary metallic shield. This shield may be either wires or tape. Observe the condition of the shield to obtain indications of the presence of moisture in the cable. If moisture is discovered, follow the procedures given in Chapter 7 for the field removal of moisture in the cable.

Removal of the Primary Shield

The wires or tape should be untwisted for the specified distance and secured.

Removal of the Auxiliary Semiconducting Shield

Great care and caution is required to avoid damage to underlying cable insulation when removing the auxiliary shield. The auxiliary shield should be removed and terminated at the specified distance and with the specified geometry.

Preparation of Cable Insulation Surface

The cable accessory manufacturer's instruction usually specifies use of abrasive cloths having a nonconducting grit and with a specific grit size. The cloth is to be used to buff or polish the cable insulation surface, which must be smooth and free of nicks, gouges, and contaminants. The surface is then wiped clean with a solvent-dampened, lint-free, cloth. The solvent should be compatible with the cable insulation. The cable insulation and conductor shield are then removed from the end of the cable to accommodate the required connector or terminal lug.

Protection of Prepared Cable End

Some installation procedures may require temporary protection of prepared cable ends until they are covered by permanent materials.

Conductor Connections

The conductor connector or terminal lug may be crimped, compressed, sweated with solder, or heat-fused. In certain applications, mechanical connections provide satisfactory performance.

Care should be used in the selection of connectors to verify that they are approved for the type and size conductor being used.

Aluminum Conductor Connections

The Aluminum Association Guide No. 51 provides guidance for selection of connectors for insulated aluminum conductors.⁴

Aluminum conductors oxidize rapidly. This oxide has an insulating value and it must be penetrated to ensure an effective connection. Though not mandatory, it is good practice to use oxide inhibitors when terminating aluminum conductors.

- a. **Crimped or Compressed** - Connectors and terminal lugs have an inhibitor compound within their bore. This compound generally contains particles, which break down the oxide film of the conductor strand surfaces when the connection is crimped. The compound prevents reforming of the oxide film. Some instructions may require wire brush cleaning of the aluminum conductor strands before their insertion into the connector. For shielded cable splices, the indentations from the crimps may require filling with conducting material.
- b. **Solder Sweated** - Special solders and techniques can be employed to achieve a solder sweated connection.
- c. **Heat-Fusion** - Heat-fusion connections use heat to achieve a fusion of metal between conductor ends and within the conductor strands. Special techniques of welding or thermite-type procedures, such as the Cadweld[®], have been successfully used.

⁴ Aluminum Association Guide no. 51, "Aluminum Building Wire Installation Manual and Design Guide."

- d. **Mechanical** - This type of connection is not typically used for splicing because of its inherent bulk. A mechanical connection lends itself more to termination applications. An inhibitor compound, such as that used in the crimped or compressed connection, must be used.
- e. **Large Sizes of Solid Aluminum** - Large sizes of solid aluminum conductors require special crimped or soldered connectors.

Copper Conductor Connections

Oxides also form on the surface of copper conductors. Typically, they do not have as high of an insulating value as the oxides that form on the surface of aluminum conductors. Also, copper oxides form at a much slower rate than aluminum oxides. This property results in somewhat simpler preparation and completion of a copper conductor connection.

- a. **Crimped or Compressed** - The gentle abrasion of the conductor strand surface before insertion into the connector or terminal lug is the recommended practice for copper connections. This type of connection should meet the performance requirements of EEI-TD-161.⁵ The indentations caused by crimping of the connector may require filling with conducting material for shielded cable connections.
- b. **Solder-Sweated** - EEI-TD-160 provides performance requirements of a split tinned copper connector.⁶
- c. **Heat-Fusion** - This type of connection uses heat to achieve fusion of metal between conductor ends and within conductor strands. Welding, brazing, silver-solder, and thermite techniques can be used.
- d. **Mechanical** - This type of connection is not usually used for splicing because of its inherent bulk. The mechanical connection lends itself more to terminating applications.

Dielectric Systems Materials

The materials used for the dielectric system can be classified as: 1) self-amalgamating, 2) premolded slip-on, 3) field-molded, and 4) shrinkable.

Self-Amalgamating

Self-amalgamating materials require the field applications of tape-type laminates to achieve a homogeneous dielectric profile. Tensioning during application is usually required to achieve self-amalgamation.

Each component of the dielectric system must be refabricated as generally outlined below:

- a. For shielded splices, the indentations or crimps of compression connectors may require filling with a conducting material. The shoulder formed at the connector and the conductor may also require filling with a conducting material to prevent failures because of high dielectric stresses.
- b. The insulating material must be applied within specified profile parameters in order to obtain acceptable dielectric stresses, both radial and tangential.
- c. The auxiliary semiconducting shield must be refabricated over the insulation to obtain an acceptable dielectric stress control.

⁵ EEI-TD-161, "Specifications for Straight Compression Type Connectors for Insulated Copper Conductors."

⁶ EEI-TD-160, "Specification for Solder-Sweated Split Tinned Copper Connectors."

- d. For continuity of the primary shield of the cable, a metallic component should be applied over the auxiliary semiconducting shield.
- e. The jacketing material used for environmental protection of the cable must be refabricated over the completed splice. A track-resistant material is used over the termination to replace the removed jacket.

The above material may consist of tapes of rubber or plastic compound, which may be purchased as kits or bulk material.

Premolded Slip-On

A premolded splice or termination is a factory-produced device using heat-amalgamated materials, which are molded into unitized modular components for rapid field assembly. The devices include in their cross section the design concept components identified for self-amalgamating cable accessories. These devices are diameter sensitive and must be correctly sized for specific construction dimensions. Because of their ease of use, their major application is to meet large volume requirements in the marketplace.

Field Molded

A field molded splice or termination is the field application of heat-amalgamated materials, usually in tape form as used in the self-amalgamating method. Heat is required with special equipment and techniques to achieve field molded profiles. Economics usually favor this method for transmission cable voltages.

Shrinkable

A shrinkable splice or termination is an assembly of materials, either heat or mechanically expanded, to achieve shrink down to prepared cable ends. They are available for both nonshielded and shielded cable systems. Repair sleeves to seal damaged cable jackets are also available.

CABLE END PREPARATION TOOLS

For extruded dielectric cables, tools are specially designed for the preparation of the cable ends during terminating and splicing. These are in addition to the normal complement of hacksaw, pliers, knives, files, ruler, diameter tape, calipers, etc.

Templates, provided by some accessory manufacturers, facilitate verifying proper dimensions.

Special tools are available for removal of cable insulation and insulation shield. A partial list of manufacturers follows:

Adalet/PLM	Cleveland, OH
G&W Electric	Blue Island, IL
Ripley/Utility Tool	Cromwell, CT
Speedsystems	Brookfield, WI

These should not to be interpreted as Southwire recommendations or as the only manufacturers or suppliers of the tools.

HARDWARE FOR INTERLOCKED ARMOR CABLES

Southwire does not make individual recommendations or approvals for this type of hardware. A partial list of manufacturers follows:

Adalet/PLM	Cleveland, OH
Appleton Elec. Co.	Chicago, IL
O-Z/Gedney	Terryville, CT
Hubbell/Kellems	Stonington, CT
Preformed Line Products	Cleveland, OH

CABLE ACCESSORIES MANUFACTURERS

Southwire does not make individual recommendations or approvals of products for terminating or splicing. A partial list of manufacturers follows:

Adalet/PLM	Cleveland, OH
Amerace/Elastimold	Hackettstown, NJ
G&W Electric	Blue Island, IL
ITT Blackburn	St. Louis, MO
Joslyn	Chicago, IL
MAC Products	Kearney, NJ
3M Co.	Austin, TX
O-Z/Gedney	Terryville, CT
Plymouth/Bishop	Canton, MA
Raychem/Sigmaform	Menlo Park/Santa Clara, CA

FIELD TESTING

The purpose of this chapter is to summarize procedural and technical information for the performance of field testing of cable systems. The procedural aspects cover subjects related to personnel and safety, but are not intended to be all-inclusive.

Manufacturers perform various electrical tests on finished wire and cable products to ensure they can safely handle their maximum voltage and current ratings. Some installation procedures- such as pulling through conduit, installation into cable trays, or framing members- can damage conductors and cables enough to create an electrical hazard. For example, incorrect calculations of pulling force, sidewall pressure, or conduit fill may lead to tearing of a conductor's insulation as it is pulled through conduit. Because post-installation testing is a good general practice, some installation contracts may require testing by the installer.

SAFETY

Electrical tests can be dangerous and should be conducted by personnel who are qualified to perform the tests. Both low potential and high potential testing have inherent hazards to personnel and equipment. Thus, a thorough understanding of the safety rules, test equipment, wiring system, and connected equipment is essential in preventing damage to the conductors and equipment, and in preventing electrical shock to the persons performing the tests. IEEE Standard 510 typifies recommended industry practices for safely conducting field testing.¹

PREPARATION FOR TESTING

Before conducting tests on any cable system, verify that the cable system is properly de-energized. If the cable system has been previously energized, you must follow the prescribed rules for conducting the switching necessary to de-energize, lock-out, tag, and ground the cable system.

High voltage conductors that are energized can induce voltage in ungrounded conductors in close proximity. It is good practice to disconnect cables from non-cable system equipment and to ground all conductors not under test for safety concerns and to prevent erroneous test results. In the case of High Voltage testing, disconnecting the cable will prevent damage to equipment and apparatus.

Check that adequate physical clearances exist between the cable ends and other equipment, other energized conductors, and to electrical ground.

At all ends remote from where the test equipment is to be connected, position a personnel guard or barricade the area to prevent unauthorized access to the cable system under test.

Note: Verify the procedures are taken to clear all tap(s) or lateral(s) in the circuit. Remove grounds from the cable phase to be tested. Phases not under test are to remain grounded at all ends.

¹ IEEE Standard 510-1992, "Recommended Practices for Safety in High Voltage and High Power Testing."

CONDUCTING TEST

Follow the instructions provided by the manufacturer of the test equipment for its proper operation.

Conduct test in accordance with prescribed procedures and instructions.

Record test results and retain for future reference.

CONCLUSION OF TESTING

Maintain grounds on all conductors until the test equipment is disconnected and packed for removal.

Caution: For HVDC tests, the accumulation of a potentially dangerous voltage can remain on the cable system if the conductors have not been grounded for a sufficient time period after the completion of the test. A rough guide is to maintain the grounds for one to four times the test duration before they are removed and the cable are reconnected into the circuit.²

Follow prescribed procedures to return or place the cable circuit into service.

FIELD ACCEPTANCE TESTS

Cable System Integrity

During the design of the power cable system, it is appropriate to evaluate the requirements of the field acceptance tests that can determine the integrity of the installed system. The following types of tests may be readily conducted.

Conductor Continuity

Tests for conductor continuity can include a simple check with an ohmmeter, 500 Volt megohm meter, or a device that measures conductor resistance. This test determines if the conductors complete an electrical circuit by ensuring the conductor metal has not been broken.

Dielectric Condition of the Cable

The electrical integrity of the system dielectric can be measured by the use of ohmmeters or megohm meters for insulation resistance. A more complex high voltage dc test, commonly referred to as a dc high-pot test, can also be done to evaluate "leakage currents."

² IEEE Standard 400-1991. "Guide for Field Testing and Evaluation of the Insulation of Shielded Power Cable Systems."

Metallic Shield Condition

For shielded cables, the metallic component of the insulation shield of jacketed cables can be tested for its condition. A continuity test can be accomplished with an ohmmeter or megohm meter tester. A more complex test arrangement is required to measure the value of the shield resistance. A comparison of the shield resistance value can then be made against specified values.

Jacket Integrity

Insulating jackets of directly buried or water-submerged cables can be tested for insulation resistance (IR). It may be possible to test integrity of conductive, nonmetallic jackets or sheaths.

Low Potential Testing of Dielectric

Insulation Resistance (IR)

The IR of the insulation components of the cable system is commonly tested using an unidirectional (dc) potential as opposed to using the ac operating frequency. Low voltage, nonshielded cables can be tested using a battery-powered ohmmeter. The reading from an ohmmeter for shielded higher voltage cables may be questionable as it does not have the capability to promote an inherent defect into an electrical fault, even though it can detect a low-resistance or bolted fault.

A megohm meter is commonly employed for the detection of questionable conditions in shielded and nonshielded cables.

Equipment and Voltage Output

Hand-held ohmmeters generally have outputs from 6 to 24 volts. They are excellent for detecting direct "shorts" such as bolted faults and low resistance measurements in the kilohm range.

Manual- or motor-driven megohm meters are available for a range of fixed dc voltages. Typical fixed dc voltages are 500, 1000, 2500, and 5000 volts. These instruments are also available with multi-voltage selections within the same device.

Interpretation of Results

Industry practice recognizes tests with a dc potential of 500 or 1000 volts dc. The insulation resistance reading should be taken after 1 minute to allow the reading to stabilize.

- For spot short time readings, IR readings should be evaluated with respect to the test conditions to determine if the results should be considered acceptable. IR readings can vary greatly depending on the environmental conditions. Conditions such as humidity, moisture in the conduits, and leftover residue on the conductor from pulling compounds are among some of the factors that influence IR readings and make detection of problems more difficult. The following "2 to 50 Megohm Rule" is a good indicator to use for evaluating IR readings.

Acceptable: A megohm meter reading of 50 megohms or higher should be considered acceptable.

Investigate: A megohm meter reading of 2 to 50 megohms may be used for deciding when to investigate the cable installation. In most cases, a 2 to 50 megohm reading does not indicate the insulation quality, therefore, 2 to 50 megohms should not be specified as a pass/fail value. These readings are usually associated with long circuit lengths, moisture, or contamination. Ends of conductors that are dirty or damp may need to be cleaned and dried.

Unacceptable: Readings less than 2 megohms will most likely indicate damaged insulation or severe test conditions.

- A more technically oriented evaluation is to use the “time resistance” technique. Good insulation shows an increasing IR with respect to time at a constant dc voltage. This is commonly called an “absorption” test.
- Some credence is given to determining the “dielectric absorption ratio.” This is the ratio of the 60-second megohm meter reading divided by the 30-second reading. This method is common for coil insulation, but is not widely accepted for cable system insulation.
- Some standards recognize a “polarization index.” This method typically is a 10-minute reading divided by the 1-minute reading.
- For tests requiring several seconds to minutes, it is important that the voltage be constant. Typically, a motor-driven megohm meter is used.

If further sophistication is desired, use the previous techniques at varying voltage levels. A downward trend of results at a higher voltage(s) is an indication of a questionable condition.

High Voltage Withstand Testing

High voltage withstand tests help determine whether a conductor can withstand a prescribed test voltage without breakdown or failure. One way to ensure that a conductor is free from major defects or installation damage is to test it at a higher ac or dc voltage than the maximum operating voltage of the conductor. The cable either withstands the voltage or it breaks down. The test does not indicate how close the cable came to failure.

High Potential DC Testing of Dielectric

The normal high potential testing procedure is to employ direct current voltages.² The use of alternating current voltages requires that the test equipment be of sufficient kVA capacity to supply the charging

current requirements of the circuit under test. Direct current voltage test equipment is much smaller and lighter than ac test equipment of equivalent test voltage output. Thus, for reasons of economics and handling, dc test equipment is predominantly used.

It is common practice when conducting high potential testing to use high voltage direct current levels (HVDC). For these situations, personnel should be familiar with IEEE Standard 400.²

² IEEE Standard 400-1991. “Guide for Field Testing and Evaluation of the Insulation of Shielded Power Cable Systems.”

Withstand Test

During Installation

Tests should be conducted on the cable prior to installation for damage that may have occurred during transit and subsequent handling. This minimizes labor and productivity losses. Applicable cable specifications define limitations on voltage and time of test. These limitations are generally within those presented in IEEE Standard 400.

Field Acceptance

After installation of the cable and prior to installing terminations or splices, it is recommended to test the cable for possible damage that may have occurred during installation. This test can be performed at a reduced level as defined in the applicable specification. The cable system may be subjected to a final acceptance test after the system is assembled, terminated, and spliced, and before connection to any non-cable equipment or devices. This test will reveal any errors in final termination of the cable system. As for the previous test, applicable specifications define voltage and time limits. These specifications also are generally within those presented in IEEE Standard 400.

Periodic Maintenance

Although not a design criteria, this topic is presented here for completeness on the types of HVDC tests that can be conducted. After the system has been in service, some organizations conduct periodic tests as a maintenance procedure to evaluate any possible deterioration of the system dielectric.

Interpretation of Results

With any HVDC testing, it is highly recommended that IEEE Standard 400 be understood and that the manufacturers of the cables, terminals, and splices concur prior to the performance of any proposed testing.

The test voltages and times for HVDC tests are defined in IEEE Standard 400. For convenience, Table 9-1 is a reproduction of a part of Table 1 of IEEE Standard 400.

TABLE 9-1

FIELD TEST VOLTAGES FOR SHIELDED POWER CABLE SYSTEMS FROM 5 KV TO 35 KV SYSTEM VOLTAGE			
System Voltage (kV rms) (phase-phase)	System BIL (kV) (crest)	Acceptance Test Voltage* (kV dc) (cond-gnd)	Maintenance Test Voltage* (kV dc) (cond-gnd)
5	75	28	23
8	95	36	29
15	110	56	46
25	150	75	61
28	170	85	68
35	200	100	75

*Acceptance test voltage duration is normally 15 minutes. Maintenance test voltage duration is normally not less than 5 minutes or more than 15 minutes.

IEEE Standard 400 tests are “go, no-go” tests. The system is required to withstand the specified voltage for the specified time duration. These tests will normally reveal gross imperfections resulting from improper field handling such as excessive bending or air gaps between the insulation and shield interfaces.

TABLE 9-2

DC TEST VOLTAGES AFTER INSTALLATION PER ICEA³			
Rated Circuit Voltage (Phase-to-Phase Voltage in Volts)	Conductor Size (AWG or kcmil)	Maximum dc Field Test Voltage (kV)	
		100 Percent Insulation Level	133 Percent Insulation Level
2001-5000	8-1000	28	28
	1001-3000	28	36
5001-8000	6-1000	36	44
	1001-3000	36	44
8001-15000	2-1000	56	64
	1001-3000	56	64
15001-25000	1-3000	80	96
25001-28000	1-3000	84	100
28001-35000	1/0-3000	100	124
35001-46000	4/0-3000	132	172

DC test voltages are applied to discover gross problems such as improperly installed accessories or mechanical damage. DC testing is not expected to reveal deterioration due to aging in service. Evidence exists that dc testing of aged cables can lead to early cable failure. For alternative testing methods to dc testing, consult IEEE P-400. The dc voltage proof test shall be made immediately after installation not exceeding the maximum specified value. The voltage shall be applied between the conductor and the metallic shield with the shield and all other metallic components of the cable grounded. The rate of increase from the initially applied voltage to the specified test voltage shall be approximately uniform and shall not be more than 100 percent in 10 seconds nor less than 100 percent in 60 seconds. The duration of the dc voltage test shall be 15 minutes.

Time-Leakage Test

For more sophisticated evaluations, it is important to recognize the components of dc “leakage” current. The output current of the test set into the cable is not the true leakage current. The output current is the sum of three currents: geometric capacitance, absorption, and true leakage current. The absolute value of output current is not of primary importance. This value is virtually impossible to predict and is dependent upon the previously mentioned factors, which can affect the resultant output current from a few to hundreds of microamperes.

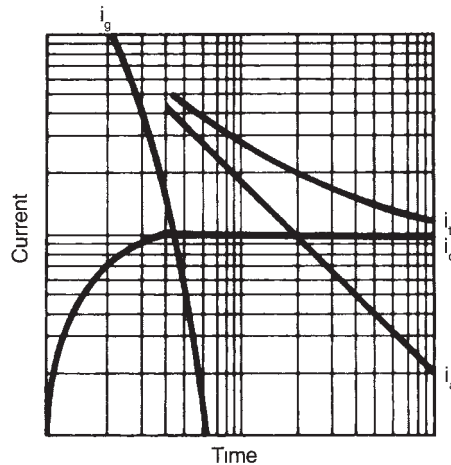

Figure 9-1
Components of DC Test Output Current

³ ICEA S-93-639 (NEMA WC 74-2000): “5 - 46 kV Shielded Power Cable for Use in the Transmission & Distribution of Electric Energy.”

where: $i_t = i_a + i_g + i_c$

i_g = geometric capacitance current

i_a = absorption current

i_c = leakage/conduction current

i_t = total current

The shape of the total current curve (i_t) with respect to time indicates the condition of the dielectric. A drop-off of current with respect to time is an indication of sound insulation. A distinct or fast rising current is an indication of questionable condition or impending failure. A flat curve is generally a result of test conditions.

The output current variation with respect to time of voltage application is generally considered more indicative than the absolute value. The characteristic shapes of the time-leakage current curve and probable causes are outlined below.

1. A **fast rising leakage curve at a steady voltage** may be indicative of faulty insulation. However, other leakage paths (over porcelain surfaces and through insulating fluids) can contribute to such a result.
2. A **falling leakage curve** is indicative of good insulation characteristics especially if it is at similar levels for all phases.
3. A **flat leakage curve** at low value is generally indicative of acceptable insulation. Flatness may be influenced by circuit length, cable geometry, and possible presence of moisture or contaminants over terminal surfaces.
4. A **flat leakage curve** at high value may indicate any of the following conditions:
 - a. presence of moisture
 - b. contaminants over terminal surfaces or other creepage surfaces
 - c. surface leakage greater than volume leakage
 - d. moist laminated insulation
 - e. condition of insulating fluids
 - f. air ionization losses (corona) from projections
5. **Dissimilar leakage curves** are indicative of non-uniformity of circuit insulation. The characteristic curve of each phase should be analyzed to determine the cause of dissimilarity. Air ionization losses from projections may affect one phase more than the others, dependent upon corona shielding (such as at terminals), temperature and humidity transients, air movement, and the like.

Generally speaking, the increase of current with test voltage is approximately linear for sound insulation. Care should be exercised to prevent terminal corona and minimize terminal surface leakage as these can mask test results.

APPENDIX RELATED INFORMATION

The appendix provides related information for power cable selection and purchasing. Included are sample calculations and many of the conversion factors or equivalents that may be encountered when working within this field.

CAPACITY AND DRUM DIAMETER OF REELS

Reel Capacity Equation

The rigorous formula for calculating footage capacities of reels for a round cable is shown as follows. A 5% nesting factor and a 95% traverse utilization have been built into the equation. Therefore, cables must be wound evenly to obtain uniformity, compactness, and the nesting of successive turns and layers.

$$F = \frac{\Pi}{12} \cdot \left\{ \left[B + \left[\frac{A - 2x - B}{1.9D} \right] \cdot 0.95D \right] \cdot \left[\frac{A - 2x - B}{1.9D} \right] \cdot \left[\frac{0.95C}{D} \right] \right\} \quad (A-1)$$

where: F = feet of cable on reel

A = flange diameter, inches

B = drum diameter, inches

C = inside traverse, inches

D = cable outside diameter, inches

X = defined as the distance between cable and the outer edge of the reel flange. Clearance is equal to 1 inch or one cable diameter, whichever is larger. On "T" suffix reels, the clearance is based on diameter less tire consideration.

ROUND CORE CABLE	
Consisting of	Multiplier for D
Single Conductor	1.0
Duplex Conductor	2.0
Triplex Conductor	2.16
Quadruplex Conductor	2.414

Typical Reel Capacity Calculation

How many feet of cable, with a diameter of 1 inch, will properly fit on a reel with the following dimensions?

$$A = 36 \text{ inches}$$

$$B = 18 \text{ inches}$$

$$C = 22 \text{ inches}$$

$$F = \frac{\pi}{12} \cdot \left\{ \left[18 + \left(\frac{36 - 2 \cdot 1 - 18}{1.9 \cdot 1.00} \right) \cdot 0.95 \cdot 1.00 \right] \cdot \left[\frac{36 - 2 \cdot 1 - 18}{1.9 \cdot 1.00} \right] \cdot \left[\frac{0.95 \cdot 22}{1.00} \right] \right\}$$

(Calculations to 2 decimal places)

$$F = \frac{\pi}{12} \{ [26.00] \cdot [8.42] \cdot [20.90] \}$$

(Truncate decimal places)

$$F = \frac{\pi}{12} \cdot (26 \cdot 8 \cdot 20)$$

$$F = 1089 \text{ ft.}$$

Approximate Reel Capacity Equation

$$F = \frac{[(A - X)^2 - B^2] \cdot (C) \cdot (0.0655)}{D^2} \text{ feet} \quad (\text{A-2})$$

where: A = flange diameter

X = clearance

Clearance is two inches or twice the cable diameter, whichever is greater. Clearance is to be taken from both sides of flange.

B = drum diameter

C = traverse

D = cable diameter

Minimum Drum Diameter

Reels used for shipment or storage should have a drum diameter (B) of not less than:

$$B = D \cdot \text{Factor} \quad (\text{A-3})$$

where: B = minimum drum diameter in inches

D = diameter of cable in inches

F = the factor for specific cable constructions taken from NEMA WC 261 and included in Table A-1

B and D are in the same units.

TABLE A-1

FACTORS FOR DETERMINING MINIMUM DRUM DISTANCES	
Type of Cable	Factor
1. Single and multiple conductor nonmetallic covered cable	
a. Nonshielded and wire shielded, including cables with concentric wires:	
1) 0-2000 volts	10
2) Over 2000 volts	
(1) Nonjacketed with concentric wires	14
(2) All Others	14
b. Tape shielded	14
2. Single and multiple conductor metallic covered cable:	
a. Tubular metallic sheathed:	
1) Lead	14
2) Aluminum:	
(1) Outside diameter - 1.750" and less	25
(2) Outside diameter - 1.751" or larger	30
b. Wire armored	16
c. Flat tape armored	16
d. Corrugated metallic sheathed	14
e. Interlocked armor	14

When metallic sheathed cables are covered only by a thermosetting or thermoplastic jacket, the "outside diameter" is the diameter over the metallic sheath itself. In all other cases, the outside diameter is the diameter outside of all the material on the cable in the state in which it is to be wound upon the reel.
For "flat twin" cables (where the cable is placed upon the reel with its flat side against the drum), the minor outside diameter should be multiplied by the appropriate factor to determine the minimum drum diameter.

TABULATIONS OF EQUIVALENTS

Nominal Conductor Area

TABLE A-2

CONDUCTOR AREA EQUIVALENTS			
Conductor Size AWG or kcmil	Area		
	Circular mils	Sq. mm	Sq. inches
14	4,110	2.08	0.00323
12	6,530	3.30	0.00513
10	10,380	5.25	0.00815
8	16,510	8.35	0.0130
6	26,240	13.3	0.0206
4	41,740	21.1	0.0328
2	66,360	33.6	0.0521
1	83,690	42.3	0.0657
1/0	105,600	53.4	0.0829
2/0	133,100	67.3	0.104
3/0	167,800	84.9	0.132
4/0	211,600	107	0.166
250	250,000	127	0.196
350	350,000	177	0.275
500	500,000	253	0.393
750	750,000	380	0.589
1000	1,000,000	507	0.785

Above values calculated based upon:
 Sq. mm = circular mil area x 506×10^{-6}
 Sq. inches = circular mil area x 0.785×10^{-6}

Conversion Factors

TABLE A-3

CONVERSION FACTORS			
Column A	Column B	A to B Multiply By	B to A Multiply By
in	mil	1,000	0.001
in	micron	1,000,000	1×10^{-6}
in	mm	25.4	0.0394
mil	mm	0.0254	39.37
ft	m	0.3048	3.2808
mile	km	1.6093	0.6214
in ²	mm ²	645.16	1.55×10^{-3}
circular mil	mm ²	5.067×10^{-4}	1973.5
circular mil	square mil	0.786	1.273
gal	liter	3.785	0.2642
fahrenheit	centigrade	$(^{\circ}\text{F}-32) \times 5/9$	$(^{\circ}\text{C} \times 9/5) + 32$
V/mil	kV/mm	.0394	25.4
horsepower	watts	745.7	1.341×10^{-3}
megohms	microhms	10^{12}	10^{-12}
megohms	ohms	10^6	10^6
micron	meter	10^{-6}	10^6
log _e (x)	log ₁₀ (x)	2.303	0.434
ohms/1000ft	ohms/km	3.28	0.3048

Temperature Equivalents**TABLE A-4**

TEMPERATURE EQUIVALENTS		
Centigrade (°C) °C = (°F - 32) x 5/9	Fahrenheit (°F) °F = (°C x 9/5) + 32	Absolute (K) °K = °C + 273
-100	-148	173
-80	-112	193
-60	-76	213
-40	-40	233
-20	-4	253
-18	0	255
0	32	273
5	41	278
10	50	283
15	59	288
20	68	293
25	77	298
30	86	303
35	95	308
40	104	313
45	113	318
50	122	323
55	131	328
60	140	333
65	149	338
70	158	343
75	167	348
80	176	353
85	185	358
90	194	363
95	203	368
100	212	373
105	221	378
110	230	383
115	239	388
120	248	393
140	284	413
160	320	433
180	356	453
200	392	473
250	482	523

All values rounded to nearest degree

Metric Unit Multiples**TABLE A-5**

METRIC UNIT MULTIPLES					
Multiple	Prefix	Symbol	Multiple	Prefix	Symbol
10 ⁻¹²	pico	p	10	deca	da
10 ⁻⁹	nano	n	10 ²	hecto	h
10 ⁻⁶	micro	μ	10 ³	kilo	k
10 ⁻³	milli	m	10 ⁶	mega	M
10 ⁻²	centi	c	10 ⁹	giga	G
10 ⁻¹	deci	d	10 ¹²	tera	T

SYMBOLS

Greek Alphabet

TABLE A-6
GREEK ALPHABET

Name	Large	Small
Alpha	Α	α
Beta	Β	β
Gamma	Γ	γ
Delta	Δ	δ
Epsilon	Ε	ε
Zeta	Ζ	ζ
Eta	Η	η
Theta	Θ	θ
Iota	Ι	ι
Kappa	Κ	κ
Lambda	Λ	λ
Mu	Μ	μ
Nu	Ν	ν
Xi	Ξ	ξ
Omicron	Ο	ο
Pi	Π	π
Rho	Ρ	ρ
Sigma	Σ	σ
Tau	Τ	τ
Upsilon	Υ	υ
Phi	Φ	φ
Chi	Χ	χ
Psi	Ψ	ψ
Omega	Ω	ω

Typical Symbol Usage

TABLE A-7

TYPICAL SYMBOL USAGE	
Symbol	Meaning – Units
V or E	Voltage – Volts
A	Amperes – Amps
R or Ω	Resistance – Ohms
A	Areas – Circular Mills – kcmil
L	Inductance – Henries
X	Reactance – Ohms
C	Capacitance – Picofarads
ρ	Volume Resistivity – Ohms – Circular Mil/Ft. Thermal – °C-cm/watt
Z	Impedance – Ohms (typically total impedance)
X_L	Inductive Reactance – Ohms
X_C	Capacitive Reactance – Ohms
α	Temperature Coefficient of Resistance
AWG	American Wire Gauge
F	Frequency – Hertz
PSI	Pounds per Square Inch
ϵ	Dielectric Constant – Permittivity
κ	Dielectric Constant
SIC	Specific Inductive Capacitance
K	(IR) Insulation Resistance Constant
pf	Power Factor
θ	Angle between Voltage and Current
δ	Imperfection Angle Between Voltage and Current tan
tan δ	Indication of insulation losses
kVA	Apparent Power – 1000 Volt Amperes
kW	Actual Power – Kilowatts – 1000 Watts
W	Power – Watts
\log_{10}	Logarithm Base 10
\log_e or \ln	Logarithm Base e (e=2.718 natural log)
ϕ	Phase
μ	Micro 10 ⁻⁶
S	Stress – Pounds/Circular Mil or Volts/Mil
μ	Coefficient of Dynamic Friction
θ	Straight Section Angle from Horizontal-Radian
Φ	Bend Section Angle – Radians
R	Bend Section Radius – Feet
β	Angle of the Pulling Line to the Direction of Pull – Degrees
Circular mil	Area of Circle Having a Diameter of 1 mil (0.001) in.
kcmil	Thousands Circular mils

REFERENCE PUBLICATIONS

Chapter 1. Basics of Insulated Power Cable Construction

1957 Edison Electric Institute (EEI) Underground Systems Reference Book (UGSRB)

T.A. Balaska, "Jointing of High Voltage Extruded Dielectric Cables: Basis of Electrical Design and Installation," 1974 IEEE Underground Transmission and Distribution Conference, Dallas, TX.

Chapter 2. Conductors

1. ASTM Standards, volume 02.03 Electrical Conductors, B 231-99, B 496-01, and B 787-01.
2. ASTM Standards, volume 02.03 Electrical Conductors, B 1-01, B 2-00, and B 3-01.
3. ASTM Standards, volume 02.03 Electrical Conductors, B 233-03 and B 800-00.
4. National Electrical Code (NEC), 2005, NFPA 70.
5. ASTM Standards, volume 02.03, B 233-03.
6. ICEA T-31-610-1994, "Water Penetration Reference Test, Sealed Conductor."
7. "Committee Report on AC/DC Resistance Ratios at 60 Cycles," ICEA Project 359, June 1958, reprinted 1973.
8. 1957 EEI UGSRB.

Chapter 3. Insulations

ICEA S-93-639 (NEMA WC 74-2000): "5 - 46 kV Shielded Power Cable for Use in the Transmission & Distribution of Electric Energy."

UL 1072, "Medium-Voltage Power Cables."

CSA C22.2, No.38-M1986, "Thermoset Insulated Wires and Cables"; CSA C68.3-97, "Shielded and Concentric Neutral Power Cables Rated 5-46kV – Third Edition."

Chapter 4. Shielding or Screening

1957 EEI UGSRB

1. ICEA S-93-639 (NEMA WC 74-2000): "5 - 46 kV Shielded Power Cable for Use in the Transmission & Distribution of Electric Energy." AEIC CS8-00 (1st edition), "Specification for Extruded Dielectric, Shielded Power Cables Rated 5 through 46kV."
2. ICEA S-93-639 (NEMA WC 74-2000): "5 - 46 kV Shielded Power Cable for Use in the Transmission & Distribution of Electric Energy."
3. ANSI/IEEE Standard 525-1992, "IEEE Guide for the Design and Installation of Cable Systems in Substations. 1992"

Chapter 5. Jacketing, Sheathing, and Armoring

ICEA S-93-639 (NEMA WC 74-2000): "5 - 46 kV Shielded Power Cable for Use in the Transmission & Distribution of Electric Energy." AEIC CS8-00 (1st edition), "Specification for Extruded Dielectric, Shielded Power Cables Rated 5 through 46kV." IEEE Standard 532-1993, "IEEE Guide for Selecting and Testing Jackets for Underground Cables." CSA C68.3-97, "Shielded and Concentric Neutral Power Cables Rated 5-46kV – Third Edition and CSA C22.2, No. 131-M89, "Type Teck 90 Cable-Third Edition; General Instruction No 1-5."

1. ICEA T-33-655-1994, "Low-Smoke, Halogen-Free (LSHF) Polymeric Cable Jackets."
2. ICEA S-93-639 (NEMA WC 74-2000): "5 - 46 kV Shielded Power Cable for Use in the Transmission & Distribution of Electric Energy", and IEEE Standard 635-2003, "IEEE Guide for Selection and Design of Aluminum Sheaths for Power Cables."
3. ICEA S-93-639 (NEMA WC 74-2000): "5 - 46 kV Shielded Power Cable for Use in the Transmission & Distribution of Electric Energy." Other standards also apply.

Chapter 6. Electrical Characteristics of Cable Systems

1. National Electrical Code (NEC), 2005, NFPA 70.
2. ICEA P-32-382, "Short Circuit Characteristics of Insulated Cable" – Fourth Edition, 1999."
3. ICEA P-45-482, "Short Circuit Characteristics of Metallic Shields and Sheaths on Insulated Cable" – Fourth Edition, 1999.
4. 1957 EEI UGSRB. ANSI/IEEE Standard 525-1992, "IEEE Guide for the Design and Installation of Cable Systems in Substations."
5. ANSI/IEEE Standard 525-1992, "IEEE Guide for the Design and Installation of Cable Systems in Substations."
6. ICEA P-53-426/NEMA WC 50-1976. "Ampacities, Including Effect of Shield Losses for Single-Conductor Solid- Dielectric Power Cable 15kV through 69kV (Copper and Aluminum Conductors). Second Edition, Revised 1999."

7. IEEE 835/ICEA P-46-426, "IEEE-ICEA Power Cable Ampacities, Copper Conductors, Aluminum Conductors. Revised 2000."
8. "Method of Symmetrical Coordinates Applied to the Solution of Polyphase Networks," C.L. Fortescue, 1918, Transactions AIEE, vol. 37, pp. 1027-1140.
9. Underground Transmission Systems Reference Book, 1992 edition, Electrical Power Research Institute.
10. Electrical Transmission and Distribution System Analysis and Design Programs, Version 3.50, August 1992, EDSA Micro Corporation, Bloomfield Hills, MI.
11. Distribution-System Protection Manual, McGraw-Edison.

Chapter 7. Cable Installation

R.C. Rifenberg, "Pipe Line Design for Pipe Type Feeders," in "AIEE Transactions on Power Apparatus and Systems" (December 1953), volume 8, paper no. 53-389.

ANSI/IEEE Standard 525-1992, "IEEE Guide for the Design and Installation of Cable Systems in Substations." ANSI/IEEE Standard 690, "IEEE Standard for the Design and Installation of Cable Systems for Class 1E Circuits in Nuclear Power Generating Stations. 2002."

1. AEIC Publication no G5-90, "Underground Extruded Power Cable Pulling, AEIC Task Group 28," 2nd edition, May 2001; and IEEE Standard 1185-1994, "Guide for Installation Methods for Generating Station Cables."
2. Gene C. Neetz, "Coefficient of Friction Measurement Between Cable and Conduit Surfaces Under Varying Loads," in 1985 IEEE Transactions on Power Apparatus and Systems, vol. PAS-104, no. 1, pp. 16-21.
3. NEC, section 300.5; National Electrical Safety Code (NESC), 2002 edition, section 35; ANSI C2-2002, Secretariat IEEE."
4. Archer E. Knowlton, ed. Standard Handbook for Electrical Engineers, 8th edition (McGraw-Hill, 1949).
5. ICEA P-79-561-1985, "Guide for Selecting Aerial Cable Messengers and Lashing Wires."
6. ICEA S-95-658 (NEMA WC70-1999) "Nonshielded Power Cables Rated 2000 Volts or Less For The Distribution of Electrical Energy." and ICEA S-93-639 (NEMA WC 74-2000): "5 - 46 kV Shielded Power Cable for Use in the Transmission & Distribution of Electric Energy."
7. IEEE 532-1993 "Guide for Selecting and Testing Jackets for Underground Cables."
8. Polywater, "Technical Talk," volume 4.

Chapter 8. Cable Accessories

T.A. Balaska, "Jointing of High Voltage Extruded Dielectric Cables: Basics of Electrical Design and Installation," 1974 IEEE Underground Transmission and Distribution Conference, Dallas, TX.

1. IEEE Standard 404-2000, "IEEE Standard for Extruded and Laminated Dielectric Shielded Cable Joints Rated 2,500V through 500,000V."
2. IEEE Standard 48-2003. "Standard for Test Procedures and Requirements for Alternating Current Cable Terminations 2.5kV through 765kV."
3. IEEE Standard 404-2000, "Standard for Extruded and Laminated Dielectric Shielded Cable Joints Rated 2,500V through 500,000V and "IEEE 592-1996 "Standard for Exposed Semiconducting Shields on High voltage Cable Joints and Separate Insulated Conductors."
4. Aluminum Association Guide no. 51, "Aluminum Building Wire Installation Manual and Design Guide."
5. EEI-TD-161, "Specifications for Straight Compression Type Connectors for Insulated Copper Conductors,"
6. EEI-TD-160, "Specification for Solder-Sweated Split Tinned Copper Connectors."

Chapter 9. Field Testing

T.A. Balaska and A.L. McKean, "Fault Location Experience and Practice on Industrial Systems," 1966 IEEE Special Technical Conference on Underground, Chicago, IL.

1. IEEE Standard 510-1992, "Recommended Practices for Safety in High Voltage and High Power Testing."
2. IEEE Standard 400-1991. "Guide for Field Testing and Evaluation of the Insulation of Shielded Power Cable Systems."
3. ICEA S-93-639 (NEMA WC 74-2000): "5 - 46 kV Shielded Power Cable for Use in the Transmission & Distribution of Electric Energy."

APPENDIX

Funk and Beaty, Standard Handbook for Electrical Engineers, 12th edition.

1. NEMA WC 26-2000, "Binational Wire and Cable Packaging Standard-EEMAC 201-2000."

A

AA-1350 (aluminum alloy), 2-12, 2-13
AA-8000 series aluminum alloy, 2-12
abrasive cloths, 8-11
absorption current, 9-6–7
acceptance tests. See testing
accessories. See cable accessories
ac/dc ratios, 2-17–18
acid resistance, 3-3, 3-4
AEIC. See Association of Edison Illuminating Companies
aerial installations, 5-3, 7-29–31
alcohols: resistance to, 3-4
alkalies: resistance to, 3-4
alternating current (ac)
 circuits, 1-5, 6-1–2, 6-12
 resistance, 2-17, 2-18, 2-19
aluminum
 and ampacity tables, 6-30–41
 and connections, 8-5, 8-11–12
 and installation, 7-11–12, 7-14, 7-31–32
 and short circuit current, 6-14, 6-18, 6-19, 6-20
 properties of, 2-3–15, 2-18, 6-58, 6-61
 sheathing, 5-3, 6-24, A-2, A-3
Aluminum Association Guide, 8-11
ambient temperature, 6-26, 6-28, 7-2, 7-14, 8-2
American Society of Testing and Materials (ASTM),
 2-3, 2-4, 2-6, 2-8, 2-9, 2-10, 2-11, 2-12, 2-13,
 3-3, 5-1
American Wire Gage (AWG), 2-1, 2-4–12, 2-14–18
ampacity, 4-3, 6-23, 6-26–29
 tables, 6-30–49
 uprating factors, 6-28
ampere determination: from power ratings, 6-10
animals: and potential damage to cable, 5-1
annealing, 2-11, 2-12
arcing, 1-4
armored cable, 1-4, 5-1–4, 6-26, 7-16, 7-21, 7-22,
 8-4, 8-5, 8-14, A-2, A-3
Association of Edison Illuminating Companies (AEIC)
 4-2, 5-1, 7-10, 7-16
ASTM. See American Society for Testing
 and Materials
auxiliary shield, 1-4, 4-1, 8-9–10, 8-11, 8-13
AWG. See American Wire Gage

B

backfill, 7-28
balanced load, 6-2
basket grip, 7-10
bend, 7-5, 7-6, 7-13–14, 7-16, 7-20, 7-22, 7-27, 7-29
 radius, 7-3, 7-4–6, 7-16, 7-19, 7-20, 7-25
bending forces, 7-20, 7-22, 7-23
binder tape, 8-9
blocking compound, 2-13
bore holes, 5-4, 7-31
braided shield, 6-21, 8-8
brazing, 8-12
breakdown strength, insulation, 6-10
breaking strengths, 2-11
Brown & Sharpe gage. See American Wire Gage
burial, 6-26, 7-28
butyl rubber, 8-5, 8-6, 8-8

C

cable accessories
 design of, 8-1–8
 installation of, 8-9–13
 manufacturers of, 8-14
cable construction, 1-1–3
cable spacing, 4-3, 6-51, 6-60, 6-61, 6-24, 6-53
cable system integrity test, 9-2, 9-3
cable tray
 and cable ampacity, 6-30
 and cable installation, 7-3–4, 7-20–23
Cadweld, 8-11
Canadian Standards Association (CSA), 5-1, 5-4, 7-9
capacitance, 6-6, 6-7, 9-6–7
capacitive reactance, 6-6–7
capacity, of reels, A-1–2
carbon black, 3-1, 3-2, 3-4
charging current, 6-7, 8-2
chemical resistance
 of insulations, 3-1
 of jackets, 5-1–2
chloride, 3-3
chlorinated polyethylene (CPE), 5-1, 5-2, 7-2, 7-14
chlorine, 3-3
chlorosulfonated polyethylene (CSP; Hypalon),
 3-3, 3-4, 5-1, 5-2, 6-28, 7-2, 7-14
circuit diagrams, 6-1–3
clamps, cable, 7-24
Class B stranded conductors, 2-8, 2-9, 2-10, 2-11,
 2-14, 2-15
Class C stranded conductors, 2-4, 2-5, 2-8, 2-9,
 2-14, 2-15

- clearance: in conduit, 7-17
 - coating: of copper wire, 2-11
 - coefficient of friction, 7-9, 7-14, 7-20, 7-21, 7-22, 7-25
 - combination unilay, 2-3
 - compact round, 2-2
 - compact sector, 2-2
 - compatibility: of cable accessories, 8-1, 8-6, 8-8, 8-11
 - components, symmetrical, 6-50
 - compressed round, 2-2
 - compressed terminal connectors, 8-5, 8-11, 8-12
 - compressed unilay, 2-3
 - concentric neutral (CN) wires: as part of primary shield, 4-1, 6-25, 6-55, 6-59, 6-60
 - concentric round, 2-2
 - concentric stranding, 2-2
 - concrete encased installations, 5-3
 - conductivity, 2-3, 2-13
 - conductor, 1-1-3, 1-4, 1-5, 2-1-6, 2-8-19, 2-21, 8-7-8, 9-2
 - aluminum as, 2-16
 - characteristics of, 2-3-11
 - copper as, 2-16
 - resistance tabulations, 2-13-21
 - shield, 1-2, 1-3, 1-4, 1-5, 4-1, 8-5, 8-7, 8-8, 8-11
 - short circuit, 6-14-20
 - size of, 2-1-9, A-3
 - strand block, 2-13
 - conduit
 - and ampacity tables, 6-30
 - and coefficient of friction, 7-14
 - dimensions and percent area, 7-18-19
 - installation of cable in, 7-1, 7-10-20
 - sweep elbow inside radius, 7-20
 - cone, stress relief, 8-4-5
 - configuration of cables, 7-15
 - connectors, 1-1, 8-12
 - construction: of insulated power cable, 1-1-5
 - contaminants: effect on time-leakage current, 9-7
 - contaminated areas: terminations in, 8-6
 - conversion factors, table, A-4
 - copper, 2-1, 2-3-16, 2-18, 2-21, 6-28, 6-61, 8-5, 8-12
 - and ampacity tables, 6-30-49
 - and short circuit current, 6-14, 6-15-17
 - installation of, 7-11, 7-31, 7-32
 - metallic shield, 5-3, 5-4, 6-21, 6-24, 6-25, 8-10
 - properties of, 2-3-12, 6-58, 6-59
 - corona, 3-1, 3-2, 7-5, 9-7
 - corrosive environment: and cable accessories, 8-2
 - corrugated sheathing, 5-3, 6-21, 7-4, A-3
 - cradled configuration, 2-18, 7-15, 7-27
 - creep, 7-29
 - crimped conductor connector, 8-11, 8-12
 - cross-linked polyethylene (XLPE), 3-1-2, 3-3-4, 6-6, 6-8
 - and installation considerations, 7-2, 7-14
 - and short circuit factors, 6-14, 6-21
 - cross-linking, 3-3, 5-1
 - CSA. See Canadian Standards Association
 - curing process, 3-1, 3-2, 3-3, 5-1
 - current, 6-23-25, 6-26
 - and grounding, 4-2, 4-3
 - and sequence impedance, 6-50-51
 - and time-leakage test, 9-6-7
 - and voltage drop, 6-11, 6-12, 6-13, 6-14
- D**
- density, conductor, 2-3
 - depth of burial, 7-28
 - desiccants, 7-33, 7-34
 - design considerations of cable accessories, 8-1, 8-2-7
 - design tests, splice, 8-8
 - diameter
 - cable assembly factor, 7-8
 - of conduit, 7-18-20
 - of copper and aluminum conductors, 2-4, 2-5, 2-6, 2-7, 2-8, 2-9
 - of reels, A-1-2
 - dielectric, 1-1-2, 1-3, 1-4, 1-5, 8-1, 8-9, 8-12
 - absorption ratio, 9-4
 - constant, 3-1, 3-2, 3-3, 3-4, 6-6
 - field, 1-2, 1-3, 1-4, 1-5, 4-1, 4-2, 6-11, 8-3, 8-7
 - strength, 1-2, 3-1-2, 3-3, 3-4
 - direct burial
 - and ampacity tables, 6-30, 6-31, 6-32, 6-33, 6-38, 6-42, 6-44, 6-47
 - installation, 7-28-29
 - direct current (dc), 6-7
 - and high potential testing, 9-4
 - circuits, 1-5, 6-1, 6-10, 6-12-14
 - resistance, 2-11, 2-13-19
 - discharge-resistant jacket, 4-2
 - dissipation factor, 3-1, 3-2, 3-3, 3-4
 - down-hole installations, 5-1
 - drain wires, 4-1
 - drum diameter, A-2, A-3
 - ducts, 5-3, 5-4, 6-26, 6-30, 7-2, 8-8-3
 - duration, electrical test, 9-5, 9-6
 - dynamometer corrections, 7-7
- E**
- earth: and direct burial, 7-28
 - earth resistivity, 6-52, 6-56, 6-57, 6-60, 6-64
 - elastomeric properties, 3-2
 - electrical characteristics of cables, 6-1-66
 - and ampacity, 6-26-49

- and sequence impedance, 6-50–66
- and shield voltage, 6-23–25
- and short circuit currents, 6-14–22
- and voltage drop, 6-11–14
- basic power system, 6-1–4
- formulas, 6-4–10
- insulation levels, 6-3, 6-4
- electrical ground, 1-2, 1-4, 1-5
- electrical insulation
 - properties of, 3-1–4
 - See also insulation
- electrical tracking, 8-2
- electromagnetic field, 4-3
- electrostatic discharges, 4-2
- electrostatic flux lines, 1-2, 1-4
- emergency overload, 6-28
- environmental conditions, 1-4, 5-1, 5-2, 8-2, 8-13
- EPR. See ethylene-propylene rubber
- equipment
 - cable installation, 7-2–4
 - electrical test, 9-1, 9-3–4
 - purging moisture, 7-33
- equipotential lines, 1–2, 1-4, 2-14
- ethylene and vinyl acetate (EVA), 3-1, 3-2
- ethylene gas, 3-1
- ethylene-propylene rubber (EPR)
 - and cable accessories, 8-5, 8-6, 8-8
 - and short circuit factors, 6-14, 6-21
 - as insulation, 3-2, 3-4, 3-6, 6-6, 6-8, 6-28, 9-6
 - installation considerations for temperature, 7-2
- expansion, 2-3, 7-2, 7-29
- extrusion, 3-1, 5-1, 5-3

F

- factors
 - conductor short circuit, 6-14
 - correction, mutual inductance, 6-23
 - for determining ac resistance, 2-19
 - or determining cable diameter, 7-8, 7-9
 - for emergency overload uprating, 6-28
 - shield short circuit, 6-21
- fault currents, 1-4, 6-50, 6-51
- field installation, 7-1–10, 8-9–13
- field testing, 9-1–7
- fill: conduit, 7-18–19
- fire performance, 3-3–3-4
- flanges, reel, 7-5, A-1–2
- flashover, 8-3
- flat tape armored cable, 5-3, A-3
- flexibility, 1-1, 3-2, 3-4, 5-2, 5-3
- fluid resistance, 3-3, 3-4, 5-1, 5-2
- frequencies
 - correction factor for ampacity, 6-29
 - correction factor for resistance, 2-19–21

- friction, coefficient of, 7-9, 7-14, 7-19–20, 7-21–23
- frost conditions, 7-28

G

- gas/vapor tight armoring, 5-3
- geometric mean distance (GMD), 6-56, 6-60–61
- geometric mean radius (GMR), 6-61–62
- Greek symbols, A-6
- ground plane, receding, 8-4–6
- ground potential, 1-4, 4-1
- grounded shields, 6-24, 6-25
- grounded systems, 6-3–4
- grounding, 1-5, 4-2–3, 9-1

H

- halogen, 3-2–3
- hazardous locations, 5-3
- heat-fused conductor connector, 8-11
- high density polyethylene (HDPE) conduit, 7-18
- high-direct-voltages (HVDC) testing, 9-1–5
- high potential testing, 9-4–7
- Hypalon, 3-3, 6-21, 7-2

I

- ICEA. See Insulated Cable Engineers Association
- identification of cable components, 8-9–10
- IEEE. See Institute of Electrical and Electronics Engineers
- impedance, 6-7, 6-9, 6-11, 6-12
 - sequence, 6-66
- impulse strength, 3-2
- inductance, 6-4–5, 6-51
 - mutual, 6-23, 6-51
- installation of cable, 7-1–35
 - aerial, 7-29–31
 - and testing, 9-1–7
 - direct burial, 7-28–29
 - field removal of moisture, 7-33–35
 - general field practices, 7-1–10
 - handling and storage guidelines, 7-5–6
 - in cable tray, 7-3–4, 7-20–23
 - in conduit, 7-3, 7-6, 7-10–20, 7-23–27
 - low temperature, 7-2
 - of cable accessories, 8-9–13
 - under vertical tension, 7-31–32
- Institute of Electrical and Electronics Engineers (IEEE)
 - standards, 4-2, 5-1, 5-2, 6-24, 6-26
 - for accessory testing, 8-6, 8-8
 - for cable accessories, 8-1
 - for field tests, 9-1–2, 9-4–6
 - for installation, 7-10, 7-28–29

- Insulated Cable Engineers Association (ICEA)
 guidelines, 2-17, 6-14, 6-28
 for conductor resistance, 2-14, 2-15, 2-17
 for installation, 7-31
 for insulation, 1-2, 3-4, 3-5
 for jacketing materials, 5-1, 5-2
 for shield resistance, 6-21, 6-25, 6-58–59
- insulated power cable construction, 1-1–5, 8-9–10
- insulation, 3-1–7
 and cable accessories, 8-3, 8-5–6, 8-8, 8-12, 8-13
 and voltage, 6-3, 6-4
 breakdown strength, 6-10
 properties of, 3-4
 resistance, 6-7–8; test, 7-33, 9-3, 9-4
 shield, 1-4, 1-5, 4-1–2, 8-3–6, 8-8, 8-13
 thickness, 3-5, 3-7
 types of, 3-1–4
- interlocked armor, 5-3, 5-4, 7-4, A-3
 splice and termination hardware, 8-14
- International Annealed Copper Standards (IACS),
 2-13
- International Electrotechnical Commission, 2-13
- interpretation of field test results, 9-3–4, 9-5
- ionization, air, 9-6–7
- J**
- jacketing, 5-1–4, 9-3
 and installation, 7-10, 7-14, 8-6, 8-9, 8-10
 and nonshielded cable, 1-1, 8-9
 and shielded cable, 1-3–4, 8-9–10
- jamming, 7-17, 7-19
- junction boxes, 7-9
- K**
- kcmil (thousand circular mils), 2-1, 2-4–12,
 2-14–15, 2-18, 2-21
- L**
- laminates, tape type, 8-12
- lead, 4-1, 5-2, 5-3, 7-5, A-3
- leakage current, 1-4, 6-7, 8-2, 9-2, 9-6–7
- line voltage, 6-2
- load current density, 1-1
- loading district, NESC, 7-30, 7-31
- longitudinal voltage stresses, 8-7
- low potential testing, 9-3–4
- low-voltage cables, 1-2
- lubricant, 4-2, 7-9–10, 7-14
- M**
- magnetic conduit: ac/dc ratio, 2-18
- maintenance tests, 9-5
- mechanical protection, 5-1, 5-3
- mechanical stresses, 6-10, 7-1
- mechanical terminal connectors, 8-5, 8-11, 8-12
- megohm meter (Megger), 7-33, 9-2–4
- melting point: of copper and aluminum, 2-3
- messenger, 6-37, 7-29, 7-31
- metal
 armor, 4-2, 5-3, A-3
 conduit, 7-14, 7-18–19
- metric unit multiples, A-5
- mid-section grounding, 4-3
- moisture
 presence of, 9-7
 protection against, 2-13, 5-2, 5-3, 5-4, 7-6, 8-2
 removal of, 7-33–35
- multiconductor cable, 1-1, 3-5
 and ampacity tables, 6-30, 6-38–41, 6-47–49
 and drum diameter, A-2–3
 and installation, 7-12, 7-16, 7-17
 and sequence impedance, 6-66
- multiple-point grounded system: for insulation
 shield, 4-2, 4-3
- N**
- National Bureau of Standards, 2-19
- National Electrical Code (NEC)
 and aluminum, 2-12, 7-11
 and ampacity, 6-26, 6-30–49
 and installation, 7-9, 7-18, 7-28, 7-32
- National Electrical Manufacturers Association
 (NEMA), 5-1
- National Electrical Safety Code (NESC), 7-28, 7-30
- neutral conductor, 6-2
- non-halogen ethylene copolymers, 3-3–4, 5-1
- non-halogen flame retardants, 3-2
- nonshielded cable, 1-1–2, 1-4, 1-5, 2-18, 3-5, 9-3, A-3
 and cable accessories, 8-1, 8-3, 8-6, 8-9
 and minimum bending radii, 7-4, 7-5
- O**
- ohmmeter, 9-2, 9-3
- oil resistance, 3-4
- open circuit shield, 4-2
- open trays, 5-3
- overhead applications: copper used for, 2-12, 2-13
- overload, emergency, 6-28
- oxide film, 8-11, 8-12
- ozone resistance, 3-2, 3-3, 3-4
- P**
- path resistances, 6-51
- PE. See polyethylene
- performance requirements, of splices, 8-8
- permittivity, 6-6
- peroxide, 3-1, 3-2
- phase conductors, 6-51, 6-54–58, 6-61

phasors, 6-50
 plasticizer, 3-3
 plowing: and direct burial of cables, 7-29
 polarization index, 9-4
 polyethylene (PE), 3-1
 and electrical characteristics, 6-6, 6-8, 6-14, 6-21, 6-28
 and installation, 7-2, 7-14
 as jacketing, 5-1, 5-2
 polymer, 3-2, 3-3, 8-6, 8-8
 polyphase systems, 6-2-3, 6-50
 polypropylene, 3-3
 polyvinyl chloride (PVC), 3-1, 3-3, 3-4
 and conduit, 7-14, 7-18-19
 and electrical characteristic, 6-6, 6-8, 6-14, 6-21, 6-28
 and installation, 7-2, 7-14
 as jacketing material, 5-1, 5-2, 5-3, 5-4
 power
 factor, 6-8-9, 6-11-12, 6-13-14
 systems, 6-1-3
 premolded slip-on material, 8-13
 premolded splice, 8-7-8, 8-13
 pressure, sidewall, 7-1, 7-4, 7-16, 7-19-20, 7-29
 primary shield, 1-4, 4-1, 4-3, 8-9, 8-10, 8-13
 propylene, 3-2
 protection
 and direct burial of cables, 7-28-29
 of prepared cable end, 8-11
 proximity effect, 2-17-18
 pull boxes, 7-8-9
 pulling
 during installation, 4-2, 7-1-9, 7-10-23
 lubricants, 4-2, 7-5-6, 7-9-10
 purging process for removal of moisture, 7-33-35
 PVC. See polyvinyl chloride

R

raceways, 5-3, 5-4, 6-30, 6-31, 6-41, 7-4
 radial stresses, 8-2, 8-7
 radius, sheave, 7-20-21
 reactance
 shield mutual, 6-23-24
 total cable, 6-7, 6-9, 6-11-12, 6-13-14
 reels
 and cable installation, 7-1-6, 7-15, 7-22-23, 7-35
 capacity equation, A-1, A-2
 relief of stress, 8-4-5, 8-6
 resistance, 2-3, 2-13, 2-15-17, 2-18-21, 6-26, 6-27
 and impedance, 6-9, 6-58, 6-59, 6-60, 6-62-63
 and voltage drop, 6-11-12, 6-13-14
 of concentric neutral, 6-56, 6-57, 6-59

 of shield, 6-21, 6-23-24, 6-25, 6-51-52, 6-55, 6-58-59, 6-60, 6-63
 resistivity, 2-3, 2-13, 3-1, 3-2, 3-4, 8-2, 8-6, 8-8
 and impedance, 6-51-52, 6-58-59
 shield, 4-3, 6-23-24, 8-2, 8-8
 riser installations, 5-1, 7-31-32
 rollers, 7-20-21
 rubber, 3-1, 8-5-6, 8-8

S

sag: and aerial installation, 7-29
 screening, 4-1
 selection of connectors, 8-11
 self-amalgamating materials, 8-12-13
 semiconducting material, 1-3, 4-1, 5-4
 sequence
 circuits, 6-50
 impedance, 6-50-66
 series circuit, 1-5
 service-entrance cable, 2-12
 service performance, 1-5, 7-1
 shafts, 5-4, 7-31, 7-32
 sheathing, 1-4, 2-17, 5-1-3, 6-26, 7-5
 sheaves, 7-3-4, 7-21, 7-23
 shield, 4-1-3, 5-1, 6-11, 7-35, 8-7-8, 8-12-13
 interrupters, 4-3
 resistance, 6-21, 6-23, 6-25, 6-51-52, 6-58, 6-62
 short circuit factors, 6-21, 6-22
 voltages, currents, and losses, 6-23-25
 shielded cable, 1-3-5, 3-5-7, 4-1-3, 7-35, A-3
 and cable accessories, 8-1-12
 and electrical characteristics, 6-6, 6-51-52
 testing of, 9-3, 9-4-5, 9-6
 short circuit, 4-2, 5-1, 6-14-22, 6-50
 sidewall pressure, 7-1, 7-4, 7-16, 7-19, 7-20, 7-29
 silane, 3-1, 3-2
 Silica Gel, 7-33
 silicate, 3-2
 single-conductor cable, 1-1-5, 2-17, 3-5, 6-6, 6-23, 6-24, 6-27, 6-60, 6-66, A-3
 and ampacity tables, 6-30, 6-32-38, 6-42-46
 and tension during installation, 7-11-12, 7-15, 7-16, 7-17
 single-phase ac systems, 6-1, 6-2, 6-10, 6-12
 single-point grounded system, 4-2-3
 size
 of conductors, 2-1-5, 6-14-20
 of conduit, 7-10, 7-18-19
 skin effect, 2-19-21, 6-58
 soil, 6-26, 6-60
 resistivity, 6-51-52, 6-60
 solder-sweat terminal connectors, 8-5, 8-11, 8-12
 solid conductors, 2-1, 2-4, 2-5, 2-6, 2-7, 2-12-15, 8-5

solvents, 3-3, 8-11
 spacing, 6-4-5, 6-23, 6-24
 conduits, 7-9
 rollers, 7-21
 vertical supports, 7-32
 splicing, 4-3, 8-1, 8-2, 8-6-8
 split tinned copper connector, 8-12
 steel
 armoring, 5-3, 5-4, 6-24
 conduit, 7-14, 7-19
 messenger, 7-31
 storage guidelines, 7-5-6
 strand block, 2-13
 street lights, cable burial depth, 7-28-29
 strength, breaking, 2-10, 2-11, 7-29, 7-31
 stress
 and cable accessories, 3-4-6, 8-2
 and voltage, 6-10-11, 8-4-7
 control layers, 4-1
 maximum allowable, on conductor, 7-11-12, 7-32
 submarine installations, 5-1
 symbols, typical, A-7
 symmetrical components, 6-50
 system categories, percent insulation level, 6-3-4

T

tangential voltage stresses, 8-7
 tape
 armor, 5-1, 5-3, 5-4
 bedding, 7-28
 shield, 6-21, 7-10
 splicing, 8-7, 8-8
 Teck Cable, 5-4
 television reception interference, 4-2
 temper, 2-11, 2-12, 2-13
 temperature
 and ampacity, 6-26-29, 6-31-49
 and impedance, 6-58-60
 and installation, 7-2, 7-14, 7-31
 and insulation, 3-2, 3-3, 6-7-8
 and resistance, 2-16-17, 2-19
 and short circuit current calculations, 6-14-21
 equivalents, table, A-5
 tensile strength, insulations, 3-2, 3-3, 3-4
 tension, pulling
 and cable configuration in conduit, 7-15
 and dynamometer corrections, 7-6-7, 7-10
 and installation, 7-10-11, 7-20-23, 7-25-27, 7-29, 7-31-32
 and maximum allowable, 7-10-12
 and plowing (direct burial), 7-29

terminal
 connector, 8-5
 lug, 8-11, 8-12
 terminations, 8-6
 tools, 8-13
 testing, 9-1-7
 field acceptance, 9-2-7
 for breakdown strength, 6-10
 of cable accessories, 8-3, 8-6, 8-8
 thermal
 circuit, 6-26-27
 expansion, 7-29
 protection, 5-1, 5-4
 resistance, 6-26, 6-27
 thermoplastic
 insulation, 3-1, 3-3, 6-14, 6-17, 6-20, 6-21
 jacket, 5-4
 thermoset insulation, 3-1, 3-2, 3-3, 6-14, 6-15, 6-16, 6-18, 6-19, 6-21, 8-9-10
 time-leakage test, 9-6-7
 track resistant material, 8-6, 8-13
 training radius, 7-4, 7-5
 treeing, 2-13, 3-1, 3-2, 5-4
 trenching, 7-28
 tubular shield, 6-21

U

UL. See Underwriters Laboratories
 ultraviolet (UV) protection, 3-1-2, 8-2
 underground
 cables, 2-12, 5-4
 duct: ampacities in, 6-30, 6-33, 6-36, 6-39, 6-45, 6-48
 Underwriters Laboratories, 2-12, 3-3, 3-5, 5-1, 7-9
 ungrounded systems, 6-3
 unilay stranded conductors, 2-3

V

vector diagrams, power factor, 6-8-9
 vertical
 riser cables, 5-4
 tension, 7-31-32
 voltage
 drop, 6-11-14
 field testing, 9-3-6
 gradients, 4-1, 6-11, 8-4, 8-5
 potentials, 6-4
 stress, 6-10-11, 8-3, 8-4, 8-5, 8-6, 8-7
 system categories, 6-3
 vulcanize, 3-1, 5-1

W

wall thickness, insulation, 3-5-7
water, 3-1, 3-4, 4-1, 5-1, 5-3, 8-6
 blocked stranded conductors, 2-13
 field removal from cables, 7-33-35
 treeing, 2-13, 3-1, 3-2, 5-4
wax, 7-9
weight
 correction, 7-15
 of copper and aluminum conductors, 2-6, 2-7,
 2-8, 2-9
 of ice, 7-30
 of steel messenger, 7-31
welding, copper conductor connectors, 8-11, 8-12
wind, 7-30-31
wire armored cable, 5-1, 5-3
withstand test, voltage, 9-5

X

XLPE. See cross-linked polyethylene

