

# UNDERGROUND TRANSMISSION SOLUTIONS

PRODUCT CATALOG





# SOUTHWIRE SOLUTIONS FOR UNDERGROUND TRANSMISSION

## CABLES

- XLPE Cables 69 through 400 kV with Copper and Aluminum conductors through 6,800 kcmil
- Concentric screen wires, seam welded corrugated sheathes and composite laminate technology, in Copper or Aluminum, cover all applications
- Southwire has supplied over 7.5 million feet of underground transmission cable to customers in North America
- Options include integrated optical fiber in metallic tube (FIMT) for distributed temperature sensing, fire retardant, low smoke, halogen free cable jackets
- Special executions include long lengths and pipe retrofit cables

## SERVICES

- Feasibility studies and conceptual engineering
- Ampacity studies
- Detailed underground system design
- Pulling calculations
- Cable pulling
- Splicing and terminating services
- Sheath bonding and grounding
- Commissioning, testing
- AC Resonant and PD testing
- Construction Management
- Full turnkey projects including civil works
- Maintenance
- Fault location
- Emergency and repair services

## ACCESSORIES

- Our accessories for Underground Transmission Solutions cable use premolded EPDM and/or LSR stress cone technology throughout, supplied by ABB Kabeldon and nkt cables
- Outdoor terminations with porcelain or silicone rubber composite insulators
- GIS and Transformer terminations to IEC 62271
- Dry "Plug and Socket" compact switchgear and transformer termination through 245 kV
- Single and three piece premolded cable splices
- Splice options include shield breaks, metal casing, heat shrink jacket, DTS fiber integration, capacitive PD detection ports, and cable size transition
- Transitions between different cable insulation types are available
- Both bolted or compression connectors available for utilization in terminations or splices/joints

### ABOUT SOUTHWIRE

A technology leader for over 65 years, Southwire Company, LLC is one of the leading wire and cable producer in North America. Southwire manufactures utility cable products including overhead and underground transmission and distribution cable. For more information about Southwire products, services, and technical resources please visit [www.southwire.com](http://www.southwire.com).

### Southwire Company, LLC

ONE SOUTHWIRE DRIVE  
CARROLLTON, GA  
30119











































1.800.444.1700  
[www.southwire.com](http://www.southwire.com)

© Registered Trademark or ™ Trademark of Southwire Company, LLC. Copyright 2016 Southwire Company. All rights reserved.





# TABLE OF CONTENTS

	<b>Installation</b>	2
	<b>KNOW YOUR OPTIONS: 69-400 kV XLPE Power Cable</b>	4
	 69 kV SW Standard Wall XLPE Corrugated Sheath	6
	 69 kV SW Standard Wall XLPE Laminate Sheath	8
	 115 kV SW Standard Wall XLPE Corrugated Sheath	10
	 115 kV SW Standard Wall XLPE Laminate Sheath	12
	 138 kV SW Standard Wall XLPE Corrugated Sheath	14
	 138 kV SW Standard Wall XLPE Laminate Sheath	16
	 230 kV SW Standard Wall XLPE Corrugated Sheath	18
	 230 kV SW Standard Wall XLPE Laminate Sheath	20
	 345/400 kV SW Standard Wall XLPE Corrugated Sheath	22
	 345/400 kV SW Standard Wall XLPE Laminate Sheath	24
	<b>KNOW YOUR OPTIONS: Underground Transmission Cable Accessories</b>	26
	Line Card	28
	Design Criteria	29
	ABB Outdoor Termination	30
	nkt cables Outdoor Termination	31
	ABB Dry Type Outdoor Termination	32
	nkt cables Dry Type Outdoor Termination	33
	ABB Switchgear & Transformer Termination CD Dry Type	34
	nkt cables Switchgear & Transformer Termination KSEV/KTEV	35
	ABB Switchgear & Transformer Termination Apega Oil Filled	36
	nkt cables Switchgear & Transformer Termination SEV/TEV	37
	ABB Joint JX Premolded One Piece	38
	nkt cables Joint KSME/SME Premolded One Piece	39
	ABB Joint SMPGB Premolded Three Piece	40
	nkt cables Joint SM Premolded Three Piece	41
	Cable Clamps	42
	Link Boxes	43
	Bonding Cable	44
	<b>Standard Cable Reels</b>	45
	<b>Project Questionnaire</b>	46

## DISCLAIMER

While great care has been employed to ensure that the applications, tables, standards and references and other information contained herein are free of errors, absolutely no warranties, either expressed or implied, are made as to the accuracy or completeness of any such tables and formulas contained herein.

Neither Southwire nor anyone else who has been involved in the creation, production or delivery of this publication shall be liable for any direct, indirect, consequential, or incidental damages arising out of the use, the results of the use, or inability to use such publication, even if Southwire has been advised of the possibility of such damages or claim. Some states do not allow the exclusion or limitation for consequential incidental damages, so the above limitation may not apply to you.

# Installation

## CURRENT RATING FOR XLPE AC LAND CABLE SYSTEMS

The XLPE cable should at least have a conductor cross section area adequate to meet the system requirements for power transmission capacity. The cost of energy losses can be reduced by using a larger conductor.

Load losses in XLPE cables are primarily due to the ohmic losses in the conductor and the metallic shield. XLPE cables can be loaded continuously to a conductor temperature of 90°C.

The dielectric losses in the XLPE insulation system are also present at no load current and depend primarily on the magnitude of the operating voltage.

Dielectric losses in XLPE cables are lower than in EPR and fluid-filled cables.

The continuous current ratings are calculated according to the IEC 60287 series of standards and with the following conditions: according to figures 1 and 2.

The ampacity was calculated with Cymcap (Version 7.0 Rev. 1) using default values.

**FIGURE 1**

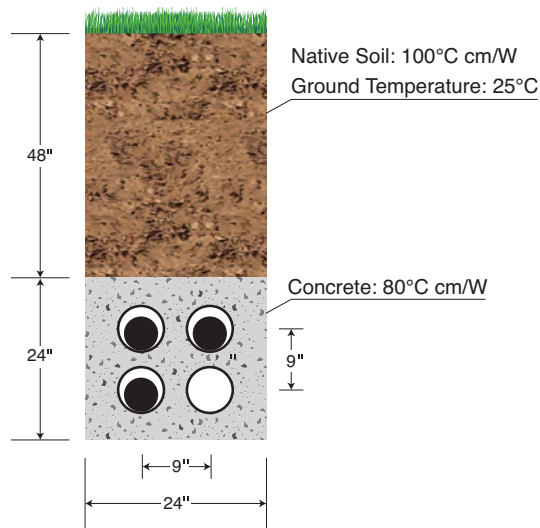

**FIGURE 2**

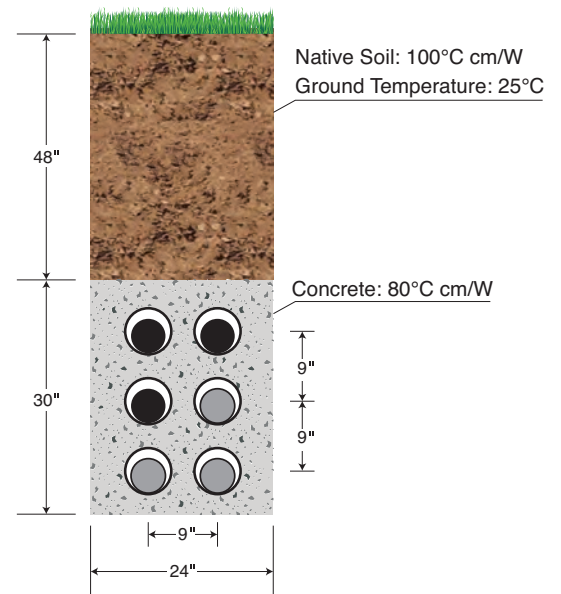





Installation

**KNOW  
YOUR  
OPTIONS:  
69-400 kV  
XLPE  
POWER  
CABLE**



## **CONDUCTOR MATERIAL AND SIZE**

The choice of the conductor material, copper or aluminum, is a matter of both customer preference and required current carrying capacity. For larger loads, copper will be your most common option. When either copper or aluminum conductors can meet your requirements, the more economical solution will be a function of the metal and the cable component costs in effect. Contact Southwire for your custom quote.

## **INSULATION THICKNESS**

For cables with a radial moisture barrier, our “Southwire(SW) Standard Wall” versions meet the stress limits recommended in AIEC CS9 [and/or IEC 60840 & 62067 as applicable for 230+ kV] while utilizing reduced insulation thicknesses. For applications requiring smaller cable diameters, specific designs are available upon request. Traditional wall thicknesses as outlined in ICEA S-108-720 are available upon request up through the 138 kV class.

## **METALLIC SHIELDING**

Southwire currently has the following options to meet your needs, all of which can be supplied as copper or aluminum:

- Screen wires
- Seam welded corrugated sheath (moisture barrier)
- Screen wires with bonded laminate (moisture barrier)

## **JACKET**

Our extruded outer jacket has a co-extruded outer semi-conductive polyethylene layer for jacket integrity testing. Fire retardant, low smoke, halogen free (LSHF) solutions are available upon request for installations in cable trays and ventilated troughs.



# 69 kV XLPE Power Cable

## SW STANDARD WALL XLPE CORRUGATED SHEATH



### CABLE CONSTRUCTION

- Concentric Stranded, Compact, or Segmental Copper or Aluminum Conductor
- Smooth Conductor Shield
- Super Clean XLPE Insulation
- True Triple Extrusion and Dry Cured
- Firmly Bonded Insulation Shield
- Copper or Aluminum Moisture Impervious Sheath
- Polyethylene Jacket with Extruded Semi-Conductive Outer Layer



CABLE DATA	
<b>Voltage Characteristics (kV)</b>	
Max Voltage Rating	72.5
BIL Rating	350
<b>Temperatures (°C)</b>	
Nominal Conductor	90
Max. Emergency Conductor	105
Short Circuit Conductor	250
Minimum Installation	-10
<b>Design Characteristics</b>	
Design Standards	AEIC, IEC
Factory Test Voltages	80 kV / 60 min.
XLPE Loss Factor	0.0005
Relative Permittivity	2.3

Conductor Size (kcmil <sup>1</sup> )	Conductor Dia.	Insulation Thickness	Diameter Over Insulation	Overall Jacket Diameter	Min. Bending Radius (install / perm.)	Capacitance	Charging Current	CU Cond & CU Sheath		AL Cond & AL Sheath			
								Cable Weight	30 mil Sheath <sup>2</sup> Short Ckt @ 0.5s	Cable Weight	50 mil Sheath <sup>2</sup> Short Ckt @ 0.5s		
	(inches)	(mils)	(inches)	(inches)	(inches)	(pF/ft)	(A/kft)	(lbs/ft)	(kA)	(lbs/ft)	(kA)		
500	0.74	354	1.54	2.19	40/27	65.87	0.99	3.47	24.7	2.03	42.5		
750	0.91	354	1.71	2.39	44/29	76.01	1.14	4.48	27.1	2.47	46.5		
1000	1.06	354	1.88	2.59	47/32	85.60	1.29	5.48	29.4	2.90	50.3		
1250	1.19	354	2.00	2.74	50/33	93.13	1.40	6.37	31.2	3.26	53.3		
1500	1.32	354	2.13	2.89	52/35	100.69	1.51	7.32	32.9	3.65	56.3		
1750	1.43	354	2.26	3.05	55/37	108.23	1.63	8.30	34.8	4.08	59.4		
2000	1.50	345	2.35	3.14	57/38	113.10	1.70	9.18	35.9	4.39	61.0		
2500	1.73	354	2.63	3.48	63/42	129.53	1.95	11.21	39.8	5.32	68.0		
3000	1.89	354	2.79	3.67	67/45	138.63	2.08	12.98	42.0	6.00	71.6		
3500	2.07	354	2.97	3.88	70/47	148.86	2.24	14.79	44.4	6.71	75.7		
4000	2.17	354	3.07	3.98	72/48	154.54	2.32	16.45	45.8	7.31	77.9		
5000	2.48	354	3.38	4.35	79/53	172.44	2.59	19.99	50.0	8.67	85.1		
Copper Conductor Size (kcmil <sup>1</sup> ) Load Factor @ 75%													
Ampacity <sup>3</sup> @ 90°C; per Figures on Page 2		500	750	1000	1250	1500	1750	2000	2500	3000	3500	4000	5000
Single Circuit (Fig 1)	Amps	600	750	870	970	1060	1130	1200	1420	1540	1630	1710	1870
Power Rating	MVA	72	90	104	116	127	135	143	170	184	195	204	223
Double Circuit (Fig 2)	Amps	520	640	740	820	890	950	1000	1200	1300	1380	1450	1570
Power Rating	MVA	62	76	88	98	106	114	120	143	155	165	173	188
Aluminum Conductor Size (kcmil <sup>1</sup> ) Load Factor @ 75%													
Ampacity <sup>3</sup> @ 90°C; per Figures on Page 2		500	750	1000	1250	1500	1750	2000	2500	3000	3500	4000	5000
Single Circuit (Fig 1)	Amps	470	590	690	780	860	920	990	1130	1250	1340	1430	1610
Power Rating	MVA	56	71	82	93	103	110	118	135	149	160	171	192
Double Circuit (Fig 2)	Amps	410	510	590	660	720	780	820	960	1050	1130	1200	1350
Power Rating	MVA	49	61	71	79	86	93	98	115	125	135	143	161

<sup>1</sup>2500-5000 kcmil conductors are 5 segment Milliken conductors.

<sup>2</sup>Thicker sheath can accommodate more FAULT current.

<sup>3</sup>Based upon single point or cross bonding scheme.



# 69 kV XLPE Power Cable

## SW STANDARD WALL XLPE LAMINATE SHEATH



### CABLE CONSTRUCTION

- Concentric Stranded, Compact, or Segmental Copper or Aluminum Conductor
- Smooth Conductor Shield
- Super Clean XLPE Insulation
- True Triple Extrusion and Dry Cured
- Firmly Bonded Insulation Shield
- Copper or Aluminum screen wires/ laminate combination
- Polyethylene Jacket with Extruded Semi-Conductive Outer Layer

CABLE DATA	
<b>Voltage Characteristics (kV)</b>	
Max Voltage Rating	72.5
BIL Rating	350
<b>Temperatures (°C)</b>	
Nominal Conductor	90
Max. Emergency Conductor	105
Short Circuit Conductor	250
Minimum Installation	-10
<b>Design Characteristics</b>	
Design Standards	AEIC, IEC
Factory Test Voltages	80 kV / 60 min.
XLPE Loss Factor	0.0005
Relative Permittivity	2.3



Conductor Size (kcmil <sup>1</sup> )	Conductor Dia.	Insulation Thickness	Diameter Over Insulation	Overall Jacket Diameter	Min. Bending Radius (install / perm.)	Capacitance	Charging Current	CU Cond, CU Screen Wires, CU Laminate	AL Cond, CU Screen Wires, AL Laminate				
	(inches)	(mils)	(inches)	(inches)	(inches)	(pF/ft)	(A/kft)	Cable Weight <sup>2</sup> (lbs/ft)	Cable Weight <sup>2</sup> (lbs/ft)				
500	0.74	354	1.54	2.10	38/26	65.87	0.99	3.64	2.63				
750	0.91	354	1.71	2.28	42/28	76.01	1.14	4.57	3.03				
1000	1.06	354	1.88	2.46	45/30	85.60	1.29	5.50	3.43				
1250	1.19	354	2.00	2.60	47/32	93.13	1.40	6.33	3.77				
1500	1.32	354	2.13	2.74	50/33	100.69	1.51	7.22	4.12				
1750	1.43	354	2.26	2.88	52/35	108.23	1.63	8.13	4.51				
2000	1.50	345	2.35	2.97	54/36	113.10	1.70	8.98	4.82				
2500	1.73	354	2.63	3.28	59/40	129.53	1.95	10.88	5.68				
3000	1.89	354	2.79	3.44	62/42	138.63	2.08	12.65	6.40				
3500	2.07	354	2.97	3.63	66/44	148.86	2.24	14.30	6.98				
4000	2.17	354	3.07	3.73	68/45	154.54	2.32	15.90	7.54				
5000	2.48	354	3.38	4.07	74/49	172.44	2.59	20.00	8.77				
Copper Conductor Size (kcmil <sup>1</sup> ) Load Factor @ 75%													
Ampacity <sup>3</sup> @ 90°C; per Figures on Page 2		500	750	1000	1250	1500	1750	2000	2500	3000	3500	4000	5000
Single Circuit (Fig 1)	Amps	620	770	900	1010	1100	1180	1250	1470	1610	1730	1840	2030
Power Rating	MVA	74	92	108	121	131	141	149	176	192	207	220	243
Double Circuit (Fig 2)	Amps	520	640	740	830	900	960	1010	1240	1350	1450	1520	1680
Power Rating	MVA	62	76	88	99	108	115	121	148	161	173	182	201
Aluminum Conductor Size (kcmil <sup>1</sup> ) Load Factor @ 75%													
Ampacity <sup>3</sup> @ 90°C; per Figures on Page 2		500	750	1000	1250	1500	1750	2000	2500	3000	3500	4000	5000
Single Circuit (Fig 1)	Amps	490	610	710	800	880	960	1020	1160	1290	1400	1500	1720
Power Rating	MVA	59	73	85	96	105	115	122	139	154	167	179	206
Double Circuit (Fig 2)	Amps	410	510	590	660	720	780	830	920	1080	1170	1250	1430
Power Rating	MVA	49	61	71	79	86	93	99	110	129	140	149	171

<sup>1</sup>2500-5000 kcmil conductors are 5 segment Milliken conductors.

<sup>2</sup>Weight based on screen sized at 279 kcmil which is calculated to accommodate 30 kA for 0.5 sec.

<sup>3</sup>Based upon single point or cross bonding scheme.



# 115 kV XLPE Power Cable

## SW STANDARD WALL XLPE CORRUGATED SHEATH



### CABLE CONSTRUCTION

- Concentric Stranded, Compact, or Segmental Copper or Aluminum Conductor
- Smooth Conductor Shield
- Super Clean XLPE Insulation
- True Triple Extrusion and Dry Cured
- Firmly Bonded Insulation Shield
- Copper or Aluminum Moisture Impervious Sheath
- Polyethylene Jacket with Extruded Semi-Conductive Outer Layer

CABLE DATA	
<b>Voltage Characteristics (kV)</b>	
Max Voltage Rating	121
BIL Rating	550
<b>Temperatures (°C)</b>	
Nominal Conductor	90
Max. Emergency Conductor	105
Short Circuit Conductor	250
Minimum Installation	-10
<b>Design Characteristics</b>	
Design Standards	AEIC, IEC
Factory Test Voltages	135 kV / 60 min.
XLPE Loss Factor	0.0005
Relative Permittivity	2.3

Conductor Size (kcmil <sup>1</sup> )	Conductor Dia.	Insulation Thickness	Diameter Over Insulation	Overall Jacket Diameter	Min. Bending Radius (install / perm.)	Capacitance	Charging Current	CU Cond & CU Sheath		AL Cond & AL Sheath			
								Cable Weight	30 mil Sheath <sup>2</sup> Short Ckt @ 0.5s	Cable Weight	50 mil Sheath <sup>2</sup> Short Ckt @ 0.5s		
	(inches)	(mils)	(inches)	(inches)	(inches)	(pF/ft)	(A/kft)	(lbs/ft)	(kA)	(lbs/ft)	(kA)		
750	0.91	512	2.03	2.78	50/34	57.76	1.45	5.13	31.6	3.06	35.7		
1000	1.06	512	2.19	2.98	54/36	64.51	1.62	6.18	33.9	3.53	38.3		
1250	1.19	512	2.32	3.13	57/38	69.78	1.75	7.10	35.7	3.92	40.3		
1500	1.32	512	2.45	3.28	60/40	75.08	1.88	8.10	37.5	4.36	42.3		
1750	1.43	512	2.58	3.44	62/42	80.36	2.01	9.10	39.3	4.80	44.3		
2000	1.50	512	2.66	3.53	64/43	83.23	2.08	10.00	40.4	5.14	45.4		
2500	1.73	512	2.95	3.87	70/47	95.22	2.38	12.10	44.4	6.14	49.9		
3000	1.89	512	3.18	4.14	75/50	104.40	2.61	14.03	47.5	6.97	53.4		
3500	2.07	512	3.28	4.26	77/52	108.68	2.72	15.74	49.0	7.60	55.0		
4000	2.17	512	3.38	4.38	79/53	112.64	2.82	17.45	50.3	8.22	56.5		
5000	2.48	512	3.69	4.74	86/57	125.09	3.13	21.75	54.6	9.65	61.3		
6000	2.67	512	3.88	5.13	93/62	132.86	3.33	24.47	57.2	10.90	64.2		
<b>Copper Conductor Size (kcmil<sup>1</sup>) Load Factor @ 75%</b>													
Ampacity <sup>3</sup> @ 90°C; per Figures on Page 2		750	1000	1250	1500	1750	2000	2500	3000	3500	4000	5000	6000
Single Circuit (Fig 1)	Amps	750	870	970	1060	1130	1200	1440	1560	1670	1760	1900	2000
Power Rating	MVA	149	173	193	211	225	239	287	311	333	351	378	398
Double Circuit (Fig 2)	Amps	640	740	820	890	940	990	1180	1280	1360	1430	1530	1620
Power Rating	MVA	127	147	163	177	187	197	235	255	271	285	305	323
<b>Aluminum Conductor Size (kcmil<sup>1</sup>) Load Factor @ 75%</b>													
Ampacity <sup>3</sup> @ 90°C; per Figures on Page 2		750	1000	1250	1500	1750	2000	2500	3000	3500	4000	5000	6000
Single Circuit (Fig 1)	Amps	590	690	780	860	920	980	1130	1250	1350	1440	1620	1760
Power Rating	MVA	118	137	155	171	183	195	225	249	269	287	323	351
Double Circuit (Fig 2)	Amps	500	580	650	720	770	820	940	1030	1110	1180	1310	1410
Power Rating	MVA	100	116	129	143	153	163	187	205	221	235	261	281

<sup>1</sup>2500-6000 kcmil conductors are 5 segment Milliken conductors.

<sup>2</sup>Thicker sheath can accommodate more FAULT current.

<sup>3</sup>Based upon single point or cross bonding scheme.





# 115 kV XLPE Power Cable

## SW STANDARD WALL XLPE LAMINATE SHEATH



### CABLE CONSTRUCTION

- Concentric Stranded, Compact, or Segmental Copper or Aluminum Conductor
- Smooth Conductor Shield
- Super Clean XLPE Insulation
- True Triple Extrusion and Dry Cured
- Firmly Bonded Insulation Shield
- Copper or Aluminum screen wires/ laminate combination
- Polyethylene Jacket with Extruded Semi-Conductive Outer Layer

CABLE DATA	
<b>Voltage Characteristics (kV)</b>	
Max Voltage Rating	121
BIL Rating	550
<b>Temperatures (°C)</b>	
Nominal Conductor	90
Max. Emergency Conductor	105
Short Circuit Conductor	250
Minimum Installation	-10
<b>Design Characteristics</b>	
Design Standards	AEIC, IEC
Factory Test Voltages	135 kV / 60 min.
XLPE Loss Factor	0.0005
Relative Permittivity	2.3



Conductor Size (kcmil <sup>1</sup> )	Conductor Dia.	Insulation Thickness	Diameter Over Insulation	Overall Jacket Diameter	Min. Bending Radius (install / perm.)	Capacitance	Charging Current	CU Cond, CU Screen Wires, CU Laminate	AL Cond, CU Screen Wires, AL Laminate				
	(inches)	(mils)	(inches)	(inches)	(inches)	(pF/ft)	(A/kft)	Cable Weight <sup>2</sup> (lbs/ft)	Cable Weight <sup>2</sup> (lbs/ft)				
750	0.91	512	2.03	2.62	48/32	57.76	1.45	5.07	3.55				
1000	1.06	512	2.19	2.80	51/34	64.51	1.62	6.04	3.99				
1250	1.19	512	2.32	2.94	53/36	69.78	1.75	6.90	4.35				
1500	1.32	512	2.45	3.08	56/37	75.08	1.88	7.83	4.74				
1750	1.43	512	2.58	3.21	58/39	80.36	2.01	8.76	5.15				
2000	1.50	512	2.66	3.31	60/40	83.23	2.08	9.63	5.48				
2500	1.73	512	2.95	3.61	65/44	95.22	2.38	11.60	6.39				
3000	1.89	512	3.18	3.85	70/47	104.40	2.61	13.68	7.16				
3500	2.07	512	3.28	3.96	72/48	108.68	2.72	15.07	7.77				
4000	2.17	512	3.38	4.07	74/49	112.64	2.82	16.72	8.36				
5000	2.48	512	3.69	4.41	80/53	125.09	3.13	20.86	9.66				
6000	2.67	512	3.88	4.62	84/56	132.86	3.33	23.50	10.93				
<b>Copper Conductor Size (kcmil<sup>1</sup>) Load Factor @ 75%</b>													
<b>Ampacity<sup>3</sup> @ 90°C; per Figures on Page 2</b>		<b>750</b>	<b>1000</b>	<b>1250</b>	<b>1500</b>	<b>1750</b>	<b>2000</b>	<b>2500</b>	<b>3000</b>	<b>3500</b>	<b>4000</b>	<b>5000</b>	<b>6000</b>
<b>Single Circuit (Fig 1)</b>	<b>Amps</b>	760	890	990	1080	1160	1230	1480	1620	1750	1850	2040	2190
<b>Power Rating</b>	<b>MVA</b>	151	177	197	215	231	245	295	323	349	368	406	436
<b>Double Circuit (Fig 2)</b>	<b>Amps</b>	640	740	830	900	960	1020	1220	1330	1430	1510	1660	1770
<b>Power Rating</b>	<b>MVA</b>	127	147	165	179	191	203	243	265	285	301	331	353
<b>Aluminum Conductor Size (kcmil<sup>1</sup>) Load Factor @ 75%</b>													
<b>Ampacity<sup>3</sup> @ 90°C; per Figures on Page 2</b>		<b>750</b>	<b>1000</b>	<b>1250</b>	<b>1500</b>	<b>1750</b>	<b>2000</b>	<b>2500</b>	<b>3000</b>	<b>3500</b>	<b>4000</b>	<b>5000</b>	<b>6000</b>
<b>Single Circuit (Fig 1)</b>	<b>Amps</b>	600	710	800	880	950	1010	1170	1300	1410	1510	1740	1900
<b>Power Rating</b>	<b>MVA</b>	120	141	159	175	189	201	233	259	281	301	347	378
<b>Double Circuit (Fig 2)</b>	<b>Amps</b>	510	590	670	730	790	840	970	1070	1160	1240	1410	1540
<b>Power Rating</b>	<b>MVA</b>	102	118	133	145	157	167	193	213	231	247	281	307

<sup>1</sup>2500-6000 kcmil conductors are 5 segment Milliken conductors.

<sup>2</sup>Weight based on screen sized at 279 kcmil which is calculated to accommodate 30 kA for 0.5 sec.

<sup>3</sup>Based upon single point or cross bonding scheme.



# 138 kV XLPE Power Cable

## SW STANDARD WALL XLPE CORRUGATED SHEATH



### CABLE CONSTRUCTION

- Concentric Stranded, Compact, or Segmental Copper or Aluminum Conductor
- Smooth Conductor Shield
- Super Clean XLPE Insulation
- True Triple Extrusion and Dry Cured
- Firmly Bonded Insulation Shield
- Copper or Aluminum Moisture Impervious Sheath
- Polyethylene Jacket with Extruded Semi-Conductive Outer Layer



<b>CABLE DATA</b>	
<b>Voltage Characteristics (kV)</b>	
Max Voltage Rating	145
BIL Rating	650
<b>Temperatures (°C)</b>	
Nominal Conductor	90
Max. Emergency Conductor	105
Short Circuit Conductor	250
Minimum Installation	-10
<b>Design Characteristics</b>	
Design Standards	AEIC, IEC
Factory Test Voltages	160 kV / 60 min.
XLPE Loss Factor	0.0005
Relative Permittivity	2.3



Conductor Size (kcmil <sup>1</sup> )	Conductor Dia.	Insulation Thickness	Diameter Over Insulation	Overall Jacket Diameter	Min. Bending Radius (install / perm.)	Capacitance	Charging Current	CU Cond & CU Sheath		AL Cond & AL Sheath			
								Cable Weight	30 mil Sheath <sup>2</sup> Short Ckt @ 0.5s	Cable Weight	50 mil Sheath <sup>2</sup> Short Ckt @ 0.5s		
	(inches)	(mils)	(inches)	(inches)	(inches)	(pF/ft)	(A/kft)	(lbs/ft)	(kA)	(lbs/ft)	(kA)		
750	0.91	591	2.18	2.97	54/36	52.20	1.57	5.49	33.9	3.39	38.2		
1000	1.06	591	2.35	3.17	58/39	58.10	1.75	6.56	36.2	3.88	40.8		
1250	1.19	591	2.48	3.32	60/40	62.71	1.88	7.50	38.0	4.29	42.8		
1500	1.32	591	2.61	3.47	63/42	67.33	2.02	8.49	39.7	4.72	44.8		
1750	1.43	591	2.74	3.63	66/44	71.93	2.16	9.52	41.6	5.20	46.8		
2000	1.50	591	2.81	3.72	68/45	74.89	2.25	10.43	42.7	5.50	47.9		
2500	1.73	591	3.10	4.06	74/49	84.87	2.55	12.56	46.7	6.56	52.5		
3000	1.89	591	3.33	4.33	78/52	92.86	2.79	14.50	49.8	7.43	56.0		
3500	2.07	591	3.44	4.45	81/54	96.58	2.90	16.24	51.3	8.08	57.6		
4000	2.17	591	3.54	4.57	83/55	100.01	3.00	17.95	52.6	8.71	59.1		
5000	2.48	591	3.85	4.93	89/60	110.83	3.33	22.29	56.9	10.12	63.8		
6000	2.67	591	4.04	5.16	93/62	117.58	3.53	25.04	59.5	11.46	66.7		
Copper Conductor Size (kcmil <sup>1</sup> ) Load Factor @ 75%													
Ampacity <sup>3</sup> @ 90°C; per Figures on Page 2		750	1000	1250	1500	1750	2000	2500	3000	3500	4000	5000	6000
Single Circuit (Fig 1)	Amps	750	860	960	1050	1110	1180	1420	1550	1650	1750	1860	1960
Power Rating	MVA	179	206	229	251	265	282	339	370	394	418	445	468
Double Circuit (Fig 2)	Amps	630	730	810	880	930	990	1170	1270	1350	1400	1490	1560
Power Rating	MVA	151	174	194	210	222	237	280	304	323	335	356	373
Aluminum Conductor Size (kcmil <sup>1</sup> ) Load Factor @ 75%													
Ampacity <sup>3</sup> @ 90°C; per Figures on Page 2		750	1000	1250	1500	1750	2000	2500	3000	3500	4000	5000	6000
Single Circuit (Fig 1)	Amps	590	690	770	850	920	980	1125	1240	1340	1430	1610	1740
Power Rating	MVA	141	165	184	203	220	234	269	296	320	342	385	416
Double Circuit (Fig 2)	Amps	500	580	650	710	770	810	930	1020	1100	1160	1300	1390
Power Rating	MVA	120	139	155	170	184	194	222	244	263	277	311	332

<sup>1</sup>2500-6000 kcmil conductors are 5 segment Milliken conductors.

<sup>2</sup>Thicker sheath can accommodate more FAULT current.

<sup>3</sup>Based upon single point or cross bonding scheme.



# 138 kV XLPE Power Cable

## SW STANDARD WALL XLPE LAMINATE SHEATH



### CABLE CONSTRUCTION

- Concentric Stranded, Compact, or Segmental Copper or Aluminum Conductor
- Smooth Conductor Shield
- Super Clean XLPE Insulation
- True Triple Extrusion and Dry Cured
- Firmly Bonded Insulation Shield
- Copper or Aluminum screen wires/ laminate combination
- Polyethylene Jacket with Extruded Semi-Conductive Outer Layer

CABLE DATA	
<b>Voltage Characteristics (kV)</b>	
Max Voltage Rating	145
BIL Rating	650
<b>Temperatures (°C)</b>	
Nominal Conductor	90
Max. Emergency Conductor	105
Short Circuit Conductor	250
Minimum Installation	-10
<b>Design Characteristics</b>	
Design Standards	AEIC, IEC
Factory Test Voltages	160 kV / 60 min.
XLPE Loss Factor	0.0005
Relative Permittivity	2.3



Conductor Size (kcmil <sup>1</sup> )	Conductor Dia.	Insulation Thickness	Diameter Over Insulation	Overall Jacket Diameter	Min. Bending Radius (install / perm.)	Capacitance	Charging Current	CU Cond, CU Screen Wires, CU Laminate	AL Cond, CU Screen Wires, AL Laminate				
	(inches)	(mils)	(inches)	(inches)	(inches)	(pF/ft)	(A/kft)	Cable Weight <sup>2</sup>	Cable Weight <sup>2</sup>				
	(inches)	(mils)	(inches)	(inches)	(inches)	(pF/ft)	(A/kft)	(lbs/ft)	(lbs/ft)				
750	0.91	591	2.18	2.80	51/34	52.20	1.57	5.36	3.84				
1000	1.06	591	2.35	2.97	54/36	58.10	1.75	6.33	4.28				
1250	1.19	591	2.48	3.11	56/38	62.71	1.88	7.22	4.66				
1500	1.32	591	2.61	3.24	59/39	67.33	2.02	8.15	5.06				
1750	1.43	591	2.74	3.38	61/41	71.93	2.16	9.10	5.49				
2000	1.50	591	2.81	3.47	63/42	74.89	2.25	9.99	5.83				
2500	1.73	591	3.10	3.78	69/46	84.87	2.55	11.98	6.79				
3000	1.89	591	3.33	4.02	73/49	92.86	2.79	13.82	7.59				
3500	2.07	591	3.44	4.14	75/50	96.58	2.90	15.50	8.21				
4000	2.17	591	3.54	4.24	77/51	100.01	3.00	17.17	8.82				
5000	2.48	591	3.85	4.57	83/55	110.83	3.33	21.32	10.13				
6000	2.67	591	4.04	4.78	87/58	117.58	3.53	23.98	11.41				
Copper Conductor Size (kcmil <sup>1</sup> ) Load Factor @ 75%													
Ampacity <sup>3</sup> @ 90°C; per Figures on Page 2		750	1000	1250	1500	1750	2000	2500	3000	3500	4000	5000	6000
Single Circuit (Fig 1)	Amps	760	880	980	1070	1150	1220	1470	1610	1730	1840	2030	2180
Power Rating	MVA	182	210	234	256	275	292	351	385	414	440	485	521
Double Circuit (Fig 2)	Amps	640	740	820	890	960	1010	1210	1320	1420	1500	1650	1760
Power Rating	MVA	153	177	196	213	229	241	289	316	339	359	394	421
Aluminum Conductor Size (kcmil <sup>1</sup> ) Load Factor @ 75%													
Ampacity <sup>3</sup> @ 90°C; per Figures on Page 2		750	1000	1250	1500	1750	2000	2500	3000	3500	4000	5000	6000
Single Circuit (Fig 1)	Amps	600	700	790	870	940	1000	1160	1290	1400	1500	1720	1890
Power Rating	MVA	143	167	189	208	225	239	277	308	335	359	411	452
Double Circuit (Fig 2)	Amps	500	590	660	720	780	830	960	1060	1150	1220	1400	1530
Power Rating	MVA	120	141	158	172	186	198	229	253	275	292	335	366

<sup>1</sup>2500-6000 kcmil conductors are 5 segment Milliken conductors.

<sup>2</sup>Weight based on screen sized at 279 kcmil which is calculated to accommodate 30 kA for 0.5 sec.

<sup>3</sup>Based upon single point or cross bonding scheme.



# 230 kV XLPE Power Cable

## SW STANDARD WALL XLPE CORRUGATED SHEATH



### CABLE CONSTRUCTION

- Concentric Stranded, Compact, or Segmental Copper or Aluminum Conductor
- Smooth Conductor Shield
- Super Clean XLPE Insulation
- True Triple Extrusion and Dry Cured
- Firmly Bonded Insulation Shield
- Copper or Aluminum Moisture Impervious Sheath
- Polyethylene Jacket with Extruded Semi-Conductive Outer Layer



CABLE DATA	
<b>Voltage Characteristics (kV)</b>	
Max Voltage Rating	245
BIL Rating	1050
<b>Temperatures (°C)</b>	
Nominal Conductor	90
Max. Emergency Conductor	105
Short Circuit Conductor	250
Minimum Installation	-10
<b>Design Characteristics</b>	
Design Standards	AEIC, IEC
Factory Test Voltages	265 kV / 60 min.
XLPE Loss Factor	0.0005
Relative Permittivity	2.3



Conductor Size (kcmil <sup>1</sup> )	Conductor Dia.	Insulation Thickness	Diameter Over Insulation	Overall Jacket Diameter	Min. Bending Radius (install / perm.)	Capacitance	Charging Current	CU Cond & CU Sheath		AL Cond & AL Sheath		
								Cable Weight	30 mil Sheath <sup>2</sup> Short Ckt @ 0.5s	Cable Weight	50 mil Sheath <sup>2</sup> Short Ckt @ 0.5s	
	(inches)	(mils)	(inches)	(inches)	(inches)	(pF/ft)	(A/kft)	(lbs/ft)	(kA)	(lbs/ft)	(kA)	
1000	1.06	945	3.08	4.06	74/49	42.73	2.14	8.57	46.7	5.73	52.5	
1250	1.19	906	3.13	4.13	75/50	47.03	2.35	9.35	47.4	6.00	53.2	
1500	1.32	906	3.26	4.28	78/52	50.12	2.51	10.40	49.2	6.50	55.2	
1750	1.43	906	3.37	4.40	80/53	52.63	2.64	11.40	50.6	6.94	56.9	
2000	1.50	906	3.45	4.50	81/54	54.30	2.72	12.37	51.8	7.33	58.0	
2500	1.73	906	3.73	4.84	88/59	61.24	3.01	14.64	55.7	8.51	62.5	
3000	1.89	906	3.96	5.11	92/62	66.54	3.33	16.70	58.9	9.47	66.0	
3500	2.07	906	4.07	5.23	95/63	69.00	3.45	18.48	60.3	10.16	67.7	
4000	2.17	906	4.17	5.35	97/65	71.27	3.57	20.24	61.7	10.84	69.2	
5000	2.48	906	4.48	5.71	103/69	78.41	3.93	24.73	66.0	12.40	73.9	
6000	2.67	906	4.67	5.94	107/72	82.86	4.15	27.57	68.6	13.83	76.9	
<b>Copper Conductor Size (kcmil<sup>1</sup>) Load Factor @ 75%</b>												
Ampacity <sup>3</sup> @ 90°C; per Figures on Page 2		1000	1250	1500	1750	2000	2500	3000	3500	4000	5000	6000
Single Circuit (Fig 1)	Amps	830	940	1020	1090	1160	1370	1490	1580	1660	1730	1810
Power Rating	MVA	331	374	406	434	462	546	594	629	661	689	721
Double Circuit (Fig 2)	Amps	710	790	860	910	960	1140	1230	1300	1360	1400	1450
Power Rating	MVA	283	315	343	363	382	454	490	518	542	558	578
<b>Aluminum Conductor Size (kcmil<sup>1</sup>) Load Factor @ 75%</b>												
Ampacity <sup>3</sup> @ 90°C; per Figures on Page 2		1000	1250	1500	1750	2000	2500	3000	3500	4000	5000	6000
Single Circuit (Fig 1)	Amps	660	750	820	890	950	1090	1190	1280	1430	1620	1760
Power Rating	MVA	263	299	327	355	378	434	474	510	570	645	701
Double Circuit (Fig 2)	Amps	560	630	690	740	790	903	980	1050	1190	1340	1440
Power Rating	MVA	223	251	275	295	315	360	390	418	474	534	574

<sup>1</sup>2500-6000 kcmil conductors are 5 segment Milliken conductors.

<sup>2</sup>Thicker sheath can accommodate more FAULT current.

<sup>3</sup>Based upon single point or cross bonding scheme.



# 230 kV XLPE Power Cable

## SW STANDARD WALL XLPE LAMINATE SHEATH



### CABLE CONSTRUCTION

- Concentric Stranded, Compact, or Segmental Copper or Aluminum Conductor
- Smooth Conductor Shield
- Super Clean XLPE Insulation
- True Triple Extrusion and Dry Cured
- Firmly Bonded Insulation Shield
- Copper or Aluminum screen wires/ laminate combination
- Polyethylene Jacket with Extruded Semi-Conductive Outer Layer

CABLE DATA	
<b>Voltage Characteristics (kV)</b>	
Max Voltage Rating	245
BIL Rating	1050
<b>Temperatures (°C)</b>	
Nominal Conductor	90
Max. Emergency Conductor	105
Short Circuit Conductor	250
Minimum Installation	-10
<b>Design Characteristics</b>	
Design Standards	AEIC, IEC
Factory Test Voltages	265 kV / 60 min.
XLPE Loss Factor	0.0005
Relative Permittivity	2.3

Conductor Size (kcmil <sup>1</sup> )	Conductor Dia. (inches)	Insulation Thickness (mils)	Diameter Over Insulation (inches)	Overall Jacket Diameter (inches)	Min. Bending Radius (install / perm.) (inches)	Capacitance (pF/ft)	Charging Current (A/kft)	CU Cond, CU Screen Wires, CU Laminate	AL Cond, CU Screen Wires, AL Laminate			
								Cable Weight <sup>2</sup> (lbs/ft)	Cable Weight <sup>2</sup> (lbs/ft)			
1000	1.06	945	3.08	3.76	68/46	42.73	2.14	7.98	5.95			
1250	1.19	906	3.13	3.81	69/46	47.03	2.35	8.72	6.19			
1500	1.32	906	3.26	3.94	71/48	50.12	2.51	9.72	6.65			
1750	1.43	906	3.37	4.06	74/49	52.63	2.64	10.66	7.08			
2000	1.50	906	3.45	4.15	75/50	54.30	2.72	11.59	7.44			
2500	1.73	906	3.73	4.45	81/54	61.24	3.01	13.68	8.53			
3000	1.89	906	3.96	4.69	85/57	66.54	3.33	15.62	9.42			
3500	2.07	906	4.07	4.81	87/58	69.00	3.45	17.35	10.09			
4000	2.17	906	4.17	4.91	89/59	71.27	3.57	19.06	10.75			
5000	2.48	906	4.48	5.25	95/63	78.41	3.93	23.40	12.23			
6000	2.67	906	4.67	5.45	99/66	82.86	4.15	26.16	13.60			
Copper Conductor Size (kcmil <sup>1</sup> ) Load Factor @ 75%												
Ampacity <sup>3</sup> @ 90°C; per Figures on Page 2		1000	1250	1500	1750	2000	2500	3000	3500	4000	5000	6000
Single Circuit (Fig 1)	Amps	850	960	1050	1120	1190	1440	1570	1690	1800	1870	1980
Power Rating	MVA	339	382	418	446	474	574	625	673	717	745	789
Double Circuit (Fig 2)	Amps	720	800	880	940	990	1190	1300	1390	1470	1660	1770
Power Rating	MVA	287	319	351	374	394	474	518	554	586	661	705
Aluminum Conductor Size (kcmil <sup>1</sup> ) Load Factor @ 75%												
Ampacity <sup>3</sup> @ 90°C; per Figures on Page 2		1000	1250	1500	1750	2000	2500	3000	3500	4000	5000	6000
Single Circuit (Fig 1)	Amps	670	760	840	910	970	1130	1250	1360	1450	1660	1820
Power Rating	MVA	267	303	335	363	386	450	498	542	578	661	725
Double Circuit (Fig 2)	Amps	570	640	700	760	810	940	1030	1120	1190	1360	1490
Power Rating	MVA	227	255	279	303	323	374	410	446	474	542	594

<sup>1</sup>2500-6000 kcmil conductors are 5 segment Milliken conductors.

<sup>2</sup>Weight based on screen sized at 279 kcmil which is calculated to accommodate 30 kA for 0.5 sec.

<sup>3</sup>Based upon single point or cross bonding scheme.



# 345/400 kV XLPE Power Cable

## SW STANDARD WALL XLPE CORRUGATED SHEATH



### CABLE CONSTRUCTION

- Concentric Stranded, Compact, or Segmental Copper or Aluminum Conductor
- Smooth Conductor Shield
- Super Clean XLPE Insulation
- True Triple Extrusion and Dry Cured
- Firmly Bonded Insulation Shield
- Copper or Aluminum Moisture Impervious Sheath
- Polyethylene Jacket with Extruded Semi-Conductive Outer Layer

CABLE DATA	
<b>Voltage Characteristics (kV)</b>	
Max Voltage Rating	420
BIL Rating	1300/1425
<b>Temperatures (°C)</b>	
Nominal Conductor	90
Max. Emergency Conductor	105
Short Circuit Conductor	250
Minimum Installation	-10
<b>Design Characteristics</b>	
Design Standards	AEIC, IEC
Factory Test Voltages (@400 kV)	440 kV / 60 min.
XLPE Loss Factor	0.0005
Relative Permittivity	2.3



Conductor Size (kcmil <sup>1</sup> )	Conductor Dia. (inches)	Insulation Thickness (mils)	Diameter Over Insulation (inches)	Overall Jacket Diameter (inches)	Min. Bending Radius (install / perm.) (inches)	Capacitance (pF/ft)	Charging Current (A/kft)	CU Cond & CU Sheath		AL Cond & AL Sheath	
								Cable Weight (lbs/ft)	30 mil Sheath <sup>2</sup> Short Ckt @ 0.5s (kA)	Cable Weight (lbs/ft)	50 mil Sheath <sup>2</sup> Short Ckt @ 0.5s (kA)
1250	1.19	1260	3.88	4.91	89/59	38.37	3.37	11.73	56.6	8.24	63.5
1500	1.32	1181	3.85	5.00	90/60	42.75	3.72	12.41	57.7	8.37	64.7
1750	1.43	1142	3.88	5.03	91/61	45.73	3.98	13.17	58.0	8.60	65.1
2000	1.50	1142	3.95	5.12	93/62	47.32	4.12	14.17	59.1	9.01	66.2
2500	1.73	1063	4.05	5.23	95/63	54.58	4.75	15.78	60.3	9.58	67.6
3000	1.89	1063	4.28	5.50	99/66	59.13	5.15	17.89	63.4	10.59	71.1
3500	2.07	1063	4.38	5.62	102/68	61.24	5.33	19.70	64.9	11.31	72.7
4000	2.17	1063	4.48	5.74	104/69	63.19	5.50	21.48	66.2	12.02	74.2
5000	2.48	1063	4.79	6.10	110/74	69.32	6.04	26.04	70.5	13.68	79.0
6000	2.67	1063	4.99	6.33	114/76	73.13	6.37	28.93	73.2	15.12	81.9
<b>Copper Conductor Size (kcmil<sup>1</sup>) Load Factor @ 75%</b>											
Ampacity <sup>3</sup> @ 90°C; per Figures on Page 2		1250	1500	1750	2000	2500	3000	3500	4000	5000	6000
Single Circuit (Fig 1)	Amps	900	990	1060	1110	1310	1430	1520	1600	1740	1820
Power Rating	MVA	624	686	734	769	908	991	1053	1109	1206	1261
Double Circuit (Fig 2)	Amps	760	820	880	920	1070	1160	1220	1290	1380	1440
Power Rating	MVA	527	568	610	637	741	804	845	894	956	998
<b>Aluminum Conductor Size (kcmil<sup>1</sup>) Load Factor @ 75%</b>											
Ampacity <sup>3</sup> @ 90°C; per Figures on Page 2		1250	1500	1750	2000	2500	3000	3500	4000	5000	6000
Single Circuit (Fig 1)	Amps	720	790	860	910	1060	1170	1260	1340	1510	1620
Power Rating	MVA	499	547	596	630	734	811	873	928	1046	1122
Double Circuit (Fig 2)	Amps	610	660	710	760	870	950	1020	1080	1200	1290
Power Rating	MVA	423	457	492	527	603	658	707	748	831	894

<sup>1</sup>2500-6000 kcmil conductors are 5 segment Milliken conductors.

<sup>2</sup>Thicker sheath can accommodate more FAULT current.

<sup>3</sup>Based upon single point or cross bonding scheme.





# 345/400 kV XLPE Power Cable

## SW STANDARD WALL XLPE LAMINATE SHEATH



### CABLE CONSTRUCTION

- Concentric Stranded, Compact, or Segmental Copper or Aluminum Conductor
- Smooth Conductor Shield
- Super Clean XLPE Insulation
- True Triple Extrusion and Dry Cured
- Firmly Bonded Insulation Shield
- Copper or Aluminum screen wires/ laminate combination
- Polyethylene Jacket with Extruded Semi-Conductive Outer Layer

CABLE DATA	
<b>Voltage Characteristics (kV)</b>	
Max Voltage Rating	420
BIL Rating	1300/1425
<b>Temperatures (°C)</b>	
Nominal Conductor	90
Max. Emergency Conductor	105
Short Circuit Conductor	250
Minimum Installation	-10
<b>Design Characteristics</b>	
Design Standards	AEIC, IEC
Factory Test Voltages (@400 kV)	440 kV / 60 min.
XLPE Loss Factor	0.0005
Relative Permittivity	2.3



Conductor Size (kcmil <sup>1</sup> )	Conductor Dia.	Insulation Thickness	Diameter Over Insulation	Overall Jacket Diameter	Min. Bending Radius (install / perm.)	Capacitance	Charging Current	CU Cond, CU Screen Wires, CU Laminate	AL Cond, CU Screen Wires, AL Laminate		
	(inches)	(mils)	(inches)	(inches)	(inches)	(pF/ft)	(A/kft)	Cable Weight <sup>2</sup> (lbs/ft)	Cable Weight <sup>2</sup> (lbs/ft)		
1250	1.19	1260	3.88	4.61	83/56	38.37	3.37	10.81	8.32		
1500	1.32	1181	3.85	4.57	83/55	42.75	3.72	11.37	8.34		
1750	1.43	1142	3.88	4.61	83/56	45.73	3.98	12.14	8.59		
2000	1.50	1142	3.95	4.69	85/57	47.32	4.12	13.08	8.96		
2500	1.73	1063	4.05	4.79	87/58	54.58	4.75	14.66	9.51		
3000	1.89	1063	4.28	5.03	91/61	59.13	5.15	16.66	10.46		
3500	2.07	1063	4.38	5.15	93/62	61.24	5.33	18.42	11.16		
4000	2.17	1063	4.48	5.25	95/63	63.19	5.50	20.14	11.83		
5000	2.48	1063	4.79	5.59	101/68	69.32	6.04	24.54	13.38		
6000	2.67	1063	4.99	5.79	105/70	73.13	6.37	27.30	14.78		
<b>Copper Conductor Size (kcmil<sup>1</sup>) Load Factor @ 75%</b>											
Ampacity <sup>3</sup> @ 90°C; per Figures on Page 2		1000	1250	1500	1750	2000	2500	3000	3500	4000	5000
<b>Single Circuit (Fig 1)</b>	<b>Amps</b>	920	1010	1090	1150	1370	1500	1600	1700	1880	2000
<b>Power Rating</b>	<b>MVA</b>	637	700	755	797	949	1039	1109	1178	1303	1386
<b>Double Circuit (Fig 2)</b>	<b>Amps</b>	770	840	900	950	1110	1220	1300	1370	1500	1590
<b>Power Rating</b>	<b>MVA</b>	533	582	624	658	769	845	901	949	1039	1102
<b>Aluminum Conductor Size (kcmil<sup>1</sup>) Load Factor @ 75%</b>											
Ampacity <sup>3</sup> @ 90°C; per Figures on Page 2		1000	1250	1500	1750	2000	2500	3000	3500	4000	5000
<b>Single Circuit (Fig 1)</b>	<b>Amps</b>	730	810	880	940	1100	1220	1320	1410	1610	1770
<b>Power Rating</b>	<b>MVA</b>	506	561	610	651	762	845	915	977	1115	1226
<b>Double Circuit (Fig 2)</b>	<b>Amps</b>	620	680	730	780	900	980	1060	1130	1290	1400
<b>Power Rating</b>	<b>MVA</b>	430	471	506	540	624	679	734	783	894	970

<sup>1</sup>2500-6000 kcmil conductors are 5 segment Milliken conductors.

<sup>2</sup>Weight based on screen sized at 279 kcmil which is calculated to accommodate 30 kA for 0.5 sec.

<sup>3</sup>Based upon single point or cross bonding scheme.



**KNOW  
YOUR  
OPTIONS:  
UNDERGROUND  
TRANSMISSION  
SOLUTIONS  
CABLE  
ACCESSORIES**

Southwire is proud to be a North American supplier of Underground Transmission Solutions cable accessories from both ABB Kabeldon and nkt cables.



# Line Card

## Southwire Underground Transmission

Supporting the Complete Power Supply Chain

### Services

#### Engineering, Project Management, Installation, and Testing

- Feasibility studies and conceptual engineering
- Detailed underground system design
- Pulling calculations
- Cable pulling
- Splicing and terminating services
- Sheath bonding and grounding
- Commissioning, testing
- AC Resonant and PD testing
- Construction Management
- Full turnkey projects including civil works
- Maintenance
- Fault location
- Emergency and repair services

### Accessories

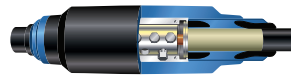

High Voltage Splice



High Voltage Terminations for all Applications

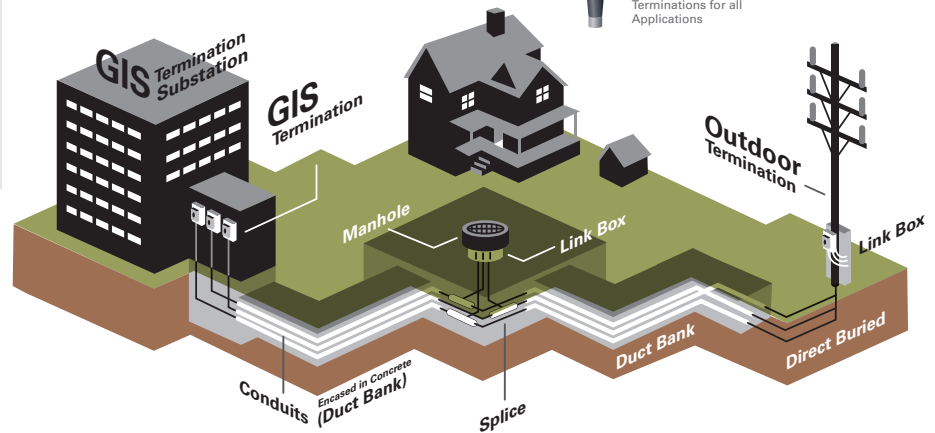

### Cables

69kV-400kV



Copper or Aluminum Segmental Conductor with a Welded Corrugated Sheath



Copper or Aluminum Conductor with a Welded Corrugated Sheath



Copper Conductor with Copper Shield Wires and a Copper Laminate Sheath



Aluminum Conductor with Aluminum Shield Wires and an Aluminum Laminate Sheath

Contact a Southwire representative for other cable constructions

The people behind the power.™



# Design Criteria

The specific electrical problems of the cable termination are found at the point between the high-grade solid electrical insulation of the cable and the gaseous insulation air, which has a significantly lower dielectric strength. In order to achieve sufficient insulating clearance, the outer conductive layer of the cable must be stripped to below the end of the core. This causes unacceptably high field intensities at the end of the outer conductive layer (Figure 1) which must be eliminated by means of stress control. Figure 2 shows the field of the cable termination controlled capacitively by a funnel shaped electrode. It is dimensioned in such a way that field intensities do not exceed at any point. This prevents harmful partial discharge.

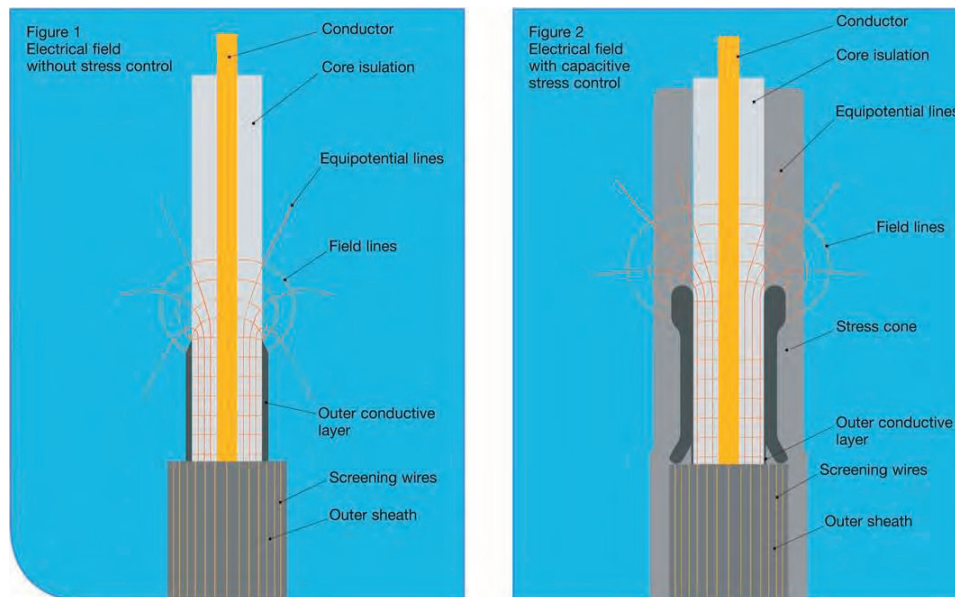

# ABB Outdoor Termination

## APED/APECB OUTDOOR TERMINATION WITH COMPOSITE INSULATOR

The cable termination consists of a composite insulator fitted on a box body made of aluminum.

The electrical stress control component is a premolded rubber stress cone. The insulator has sheds of short-long type and is filled with synthetic insulating oil. The composite insulator is available in grey. A bolt clamp in the top fitting is used to connect the conductor to the top bolt. Top bolt and bolt clamp are included in the kit. For 420 kV a corona shield is included.

- Premolded stress control
- Box body made of aluminum
- Complete with stand-off insulators for box body isolation from ground (included in APECB, optional for APED)
- Top bolt available in copper or aluminum
- Different top bolt diameters available according to cable dimensions
- Type tested according to IEEE 48 and IEC 60840, 62067 where applicable

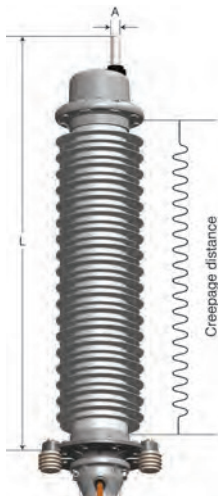
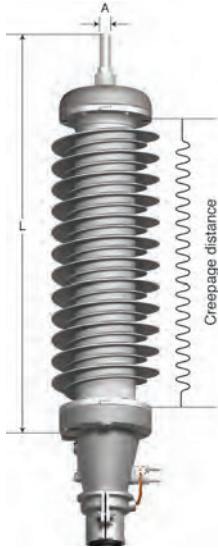

Type	APED	APECB		
Operation Voltage Um (kV)	72	145	245	420
Conductor Cu/Al Max. (kcmil)	2500	5000	5000	5000
Diameter Over Dielectric Min.-Max. (inches)	1-2.6	1.8-4.2	2.9-4.7	3.1-4.9
Diameter Over Jacket Max. (inches)	3.3	6.7	6.7	6.7
Length L (inches)	42.3	68.7	124.2	186
Creepage Distance Min. (inches)	91.7	147.6	368.5	586.6
Top Bolt Diameter A (mm)	30	40/50/54/60		

# nkt cables Outdoor Termination

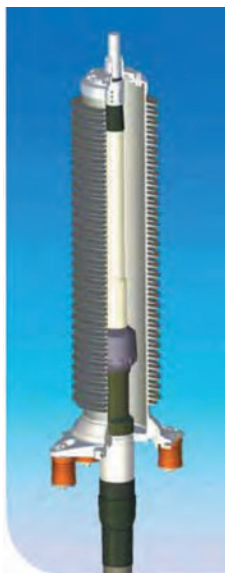

## FEV-V OUTDOOR TERMINATION WITH COMPOSITE INSULATOR

The different versions of this outdoor termination type FEV-V are designed for operation under severe outdoor conditions. Main components of the termination are the composite insulator with upper metal work, metal base plate with supporting insulators, and premolded stress cone for electrical field control.

- Integrated premolded stress control system made of silicone rubber
- All metalwork made of corrosion resistant aluminum alloy
- Termination is standing on supporting pedestal insulators, so that the cable screen can be isolated from earth
- Silicone fluid filled
- Top bolt available in two versions, screw type or press type
- Different top bolt diameter available suiting to the cable dimensions
- Type tested on Southwire Cable according to IEEE 48 and IEC 60840

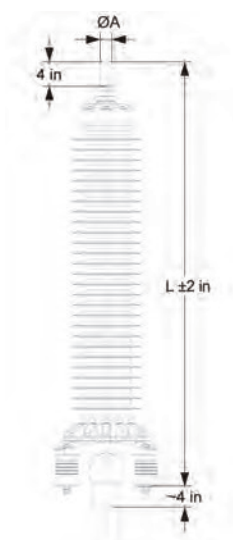

Type	FEV 72-V	FEV 145-V	FEV 245-V	FEV 420-V
Operation Voltage Um (kV)	72	145	245	420
Conductor Cu/Al Max. (kcmil) <sup>1</sup>	5000	5000	5000	5000
Diameter Over Dielectric Min.-Max. (inches)	1.4-3.8	1.4-3.3	1.4-4.3	4.7
Diameter Over Jacket Max. (inches)	4.1	4.1	N/A	N/A
Length L (inches)	55.1	74.8/82.6	108	165
Creepage Distance Min. (inches)	71.4	121/207.5	291	496
Top Bolt Diameter A (mm)	50	50	60	60

<sup>1</sup>2500 up to 5000 kcmil special crimping tool is required.

# ABB Dry Type Outdoor Termination



## TD 145 PRE-ASSEMBLED OUTDOOR TERMINATION

Suitable for outdoor and indoor installations in which the termination is to be used as a fixed connection point. Especially suitable for applications where oil is not preferred or when installation time/cost is crucial.

TD 145 contains a pre-assembled cable termination, top bolt and bolt clamp in the top fitting, cable clamp, and earth clamp. The pre-assembled cable termination consists of a composite insulator with integrated base part and stress cone. Both the support pipe and the cable clamp are made of fiberglass reinforced polyester that provides an insulated screen/sheath installation. The field control component is a pre-molded stress cone. The termination has a minimum creepage distance of 183 inches, which means it fulfills Pollution class IV according to IEC 60815-3.

- Free of insulation liquid, no filling procedure
- Less parts to be assembled therefore faster installation
- All metal work made of corrosion resistant aluminum alloy
- Type test certificate in accordance with IEC 60840 available

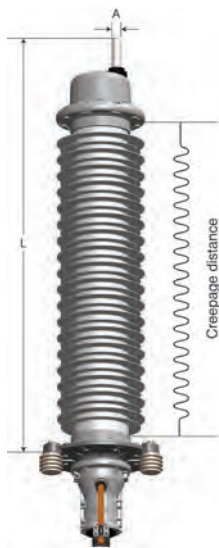

Type	TD
Operation Voltage Um (kV)	145
Conductor Cu/Al Max. (kcmil)	5000
Diameter Over Dielectric Min.-Max. (inches)	2.1-4
Diameter Over Jacket Max. (inches)	5.9
Length L (inches)	69.3
Creepage Distance Min. (inches)	183
Top Bolt Diameter A (mm)	40/50/54/60

# nkt cables Dry Type Outdoor Termination

## KFEV 145-V PRE-ASSEMBLED OUTDOOR TERMINATION

This new generation of dry type termination is free of any liquid and gaseous insulation medium. Main components of the termination are the push-on silicone components with integrated stress cone for electrical field control and the liquid free epoxy resin insulator with silicone sheds.

- Free of insulation liquid, no filling procedure
- Less parts to be assembled therefore faster installation
- Prefabricated capacitive silicone stress control system
- Plug-in part comprising four components (stress cone made of silicone rubber, cable gland, connection bolt and spring loaded compression device)
- Easy to fit screw type conductor connector
- All metalwork made of corrosion resistant aluminum alloy
- Type test certificate in accordance with IEC 60840 available

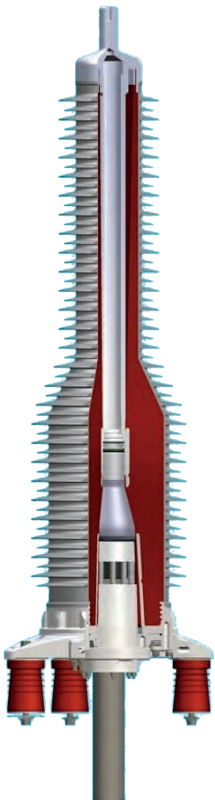

Type	KFEV 145-V
Operation Voltage Um (kV)	145
Conductor Cu/Al Max. (kcmil)	2500
Diameter Over Dielectric Min.-Max. (inches)	1.4-3
Diameter Over Jacket Max. (inches)	3.9
Length L (inches)	69
Creepage Distance Min. (inches)	177
Top Bolt Diameter A (mm)	50



# ABB Switchgear & Transformer Termination

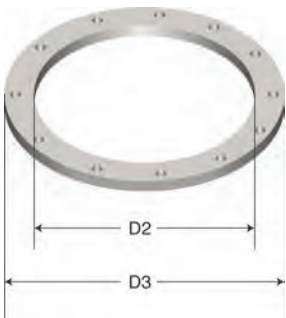
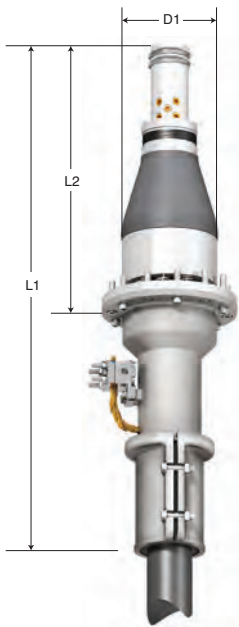

## CD DRY TYPE PLUG-IN TERMINATION FOR GAS INSULATED SWITCHGEAR AND TRANSFORMER UP TO 170 kV

Dry plug-in cable termination suitable as a fixed connection point in a gas-insulated switchgear, a transformer without a separate cable box, or where the cable box is filled with transformer oil.

The cable termination is to be ordered in two separate kits:

1. CD 145, CD 170; plug-in termination kit consisting of plug-in termination, locking halves, stress cone, pre-loaded spring assembly, box body, earth clamp, and cable clamp.
  2. CDI 145, CDI 170; insulator kit consisting of top fitting, epoxy insulator with integrated screen separation, and pressure ring.
- Type tested to IEC 60840
  - Dimensions according to IEC 62271-209, dry-type design
  - CST Corona shield for transformer (TRF) applications, made of aluminum with surface insulation coating
  - CBT Contact bolt for transformer (TRF) applications, if required
  - ECDI Extension kit from 470 mm to 757 mm, if required

Type	CD
Operation Voltage Um (kV)	145/170
Conductor Cu/Al Max. (kcmil)	4000
Diameter Over Dielectric Min.-Max. (inches)	1.7-3.8
Diameter Over Jacket Max. (inches)	5.9
Length L1 (mm)	1149
Length L2 (mm)	470
D1 (mm)	250
D2 (mm)	283
D3 (mm)	345



# nkt cables Switchgear & Transformer Termination

## KSEV/KTEV DRY TYPE PLUG-IN TERMINATION UP TO 245 kV

All versions of dry-type termination are designed for installation in SF<sub>6</sub> gas insulated switchgear (GIS) or for installation in the oil filled cable box of the transformer. The complete termination consists of epoxy resin insulator with embedded electrode, fixing ring which is fitted to the cable, comprising metal cable gland, compression device, and premolded plug-in stress cone for electrical field control.

- Plug-in part comprising of four components (stress cone made of silicone rubber, cable gland, connection bolt and spring-loaded compression device)
- Insulator according with IEC 60859 (145) and 62271-209 (245) for GIS and transformer termination
- Conductor connection bolt designed as mechanical screw type connector
- Combination with different adaptor and additional electrodes available
- Type test certificate in accordance with IEC 60840, 62067 available
- Dead-end plug available

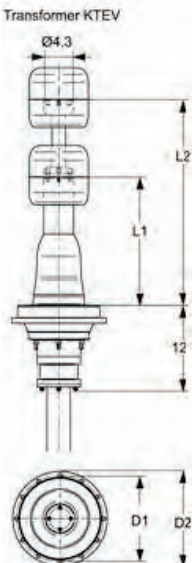
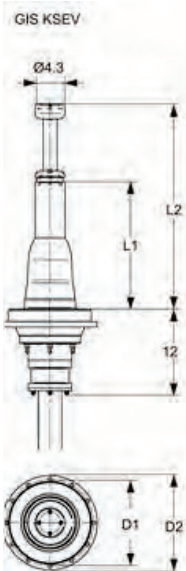

Type Switchgear Transformer	KSEV 72 KTEV 72	KSEV 145 KTEV 145	KSEV 245 KTEV 245
Operation Voltage Um (kV)	72	145	245
Conductor Cu/Al Max. (kcmil)	2000	2500	5000
Diameter Over Dielectric Min.-Max. (inches)	1.5-2.9	1.5-2.9	1.8-3.9
Diameter Over Jacket Max. (inches)	3.9	3.9	5.3
Length L1 (mm)	310	470	620
Length L2 (mm)	582	757	960
D1 (mm)	245	266	475
D2 (mm)	300	350	500

# ABB Switchgear & Transformer Termination

## APEGA OIL FILLED PLUG IN TERMINATION FOR GAS INSULATED SWITCHGEAR AND TRANSFORMER UP TO 420 kV

Oil filled cable termination suitable as a fixed connection point in a gas-insulated switchgear, a transformer without a separate cable box, or where the cable box is filled with transformer oil.

The cable termination consists of an epoxy insulator fitted to a box body made of aluminum. The stress controlling component is a rubber stress cone. The insulator is filled with synthetic insulating oil. A flange for insulated installation is integrated in the epoxy insulator. A pressure ring is also included.

- CST Corona shield for transformer (TRF) applications, made of aluminum with surface insulation coating
- CBT Contact bolt for transformer (TRF) applications, if required
- Type tested to IEC 60840, 62067, and IEEE 48
- Dimensions according to IEC 62271-209

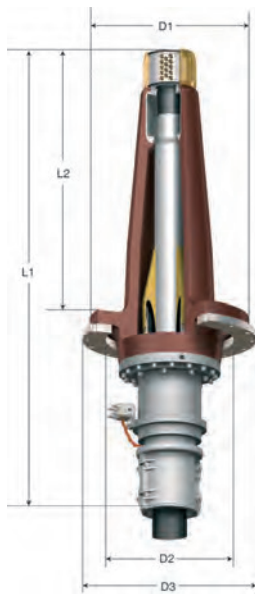

Type	APEGA	APEGA	APEGA
Operation Voltage Um (kV)	170	245	420
Conductor Cu/Al Max. (kcmil)	4000	6000	6000
Diameter Over Dielectric Min.-Max. (inches)	1.8-4.2	2.9-4.7	3.2-4.7
Diameter Over Jacket Max. (inches)	6.3	6.3	6.3
Length L1 (mm)	1460	1670	2175
Length L2 (mm)	757	960	1400
D1 (mm)	298	450	614
D2 (mm)	270	450	464
D3 (mm)	345	612	570

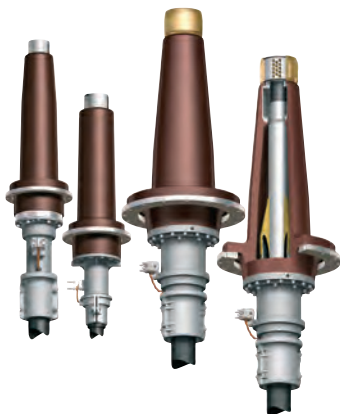



# nkt cables Switchgear & Transformer Termination

SEV 72 kV

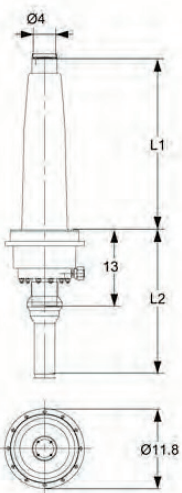

## SEV/TEV EPOXY INSULATOR TERMINATION

The termination is designed for direct installation in SF<sub>6</sub> gas insulated switchgear (GIS) or in the oil filled cable box of the transformer. Major components of the termination are the pressure tight epoxy resin insulator with embedded electrode, metal fixing ring, metal cable gland, and prefabricated stress cone for electrical field control.

- Integrated prefabricated stress control system with silicon rubber
- Pressure tight epoxy resin insulator cast in one piece with integrated insulation ring at the bottom allowing to separate the cable screen from earth
- Cable gland made of corrosion resistant aluminum alloy
- Possible installation position vertical up to 45°, then up to 90° with oil expansion vessel required
- Type test according to IEC 60840 available

TEV 145/170 kV

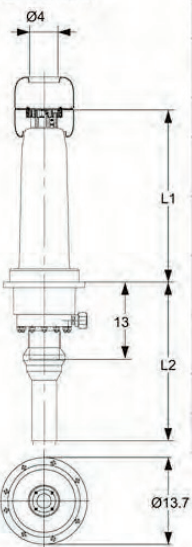

Type Switchgear Transformer	SEV 72 TEV 72	SEV 145 TEV 145
Operation Voltage Um (kV)	72	145
Conductor Cu/Al Max. (kcmil)	2000	5000
Diameter Over Dielectric Min.-Max. (inches)	1.3-2.9	1.6-4.3
Diameter Over Jacket Max. (inches)	3.3	4.1
Creepage Distance (inches)	19.7	25.6
Length L1 (mm)	583	757
Length L2 (mm)	630	630

# ABB Joint

## JX PREMOLDED ONE PIECE CABLE JOINT

Premolded cable joints for XLPE insulated cables with aluminum or copper conductors and various types of cable screens and cable sheaths. The joint is available with or without integrated screen interruption for cross bonding of cable screens. Designed to meet the requirements of internationally accepted standards.

The joint body is made of rubber in three layers: a conductive inner layer, an insulating layer, and a conductive outer layer in one piece. The cable joint is supplied with a heat-shrink outer jacket.

- Available with or without screen interruption
- Supplied with bolted connector
- Designed with heat-shrink outer jackets with additional sealing at all ends to prevent longitudinal water ingress
- Includes a heat-shrink crutch-seal and filling compound for moisture and mechanical protection of outgoing cross-bonding cable
- Meets the requirements of IEC 60840 including Annex G, IEC 62067 including Annex G, and IEEE 404 (JX 245) where applicable
- JX 245 available with prefabricated PUR casted copper casing for cable with metallic sheath

Type	JX	JX	JX
Operation Voltage Um (kV)	72	123	245
Conductor Cu/Al Max. (kcmil)	3000	5000	5000
Diameter Over Dielectric Min.-Max. (inches)	1.3-3.0	1.8-3.9	2.9-4.7
Diameter Over Jacket Max. (inches)	3.7	7.5	5.6
Length (inches)	70.9	70.9	70.9
Outer Diameter (inches)	9.3	11.8	11.8
Insulation Material	Silicone	Silicone	EPDM

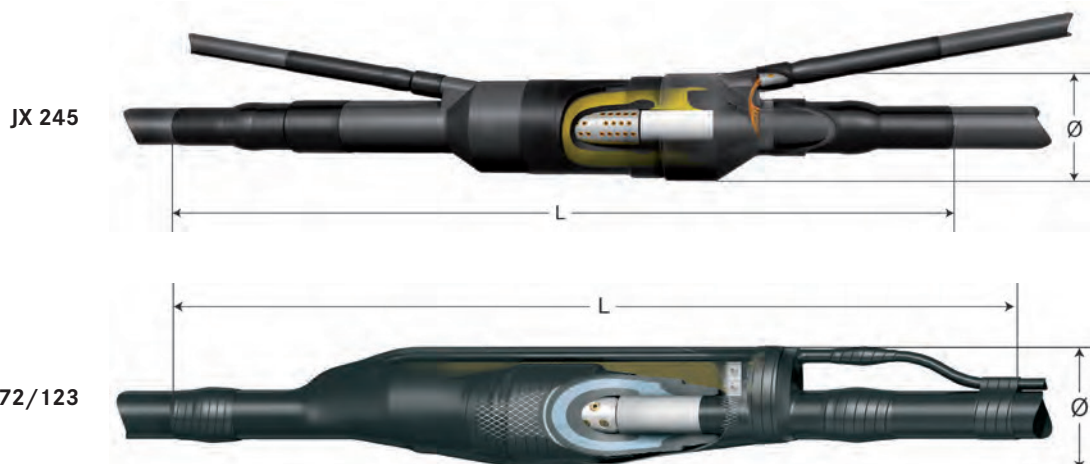



# nkt cables Joint

## KSME/SME PREMOLDED ONE PIECE CABLE JOINT

This premolded straight joint in one piece design with compact dimensions is made of silicone rubber. Main components of the standard straight joint are conductor connection sleeve, main joint sleeve, and outer protective covering.

- Very short and compact design
- Easy push on installation
- Minimum tools and installation space needed
- Screw or compression type conductor connector
- Version with screen separation available
- Additional outer protection housings available
- Type test certificate in accordance with IEC 60840/62067 available

Operation Voltage Um (kV)	Type	Conductor Cu/Al Max. (kcmil) <sup>1</sup>	Diameter Over Dielectric Max. (inches)	Diameter Joint Approx. (inches)	Length Joint Approx. (inches)
72	KSME/SME 72 Size 36	1250	2.1	5.9	70.9
72	KSME/SME 72 Size 46	2000	2.6		
145	KSME/SME 145 Size 4	3000	3.3	6.7	78.7
145	KSME/SME 145 Size 6	5000	4.7	9.4	92.5
245	KSME/KSM 245 Size 6	5000	4.7	9.4	92.5

<sup>1</sup>2500 up to 5000 kcmil special crimping tool is required.

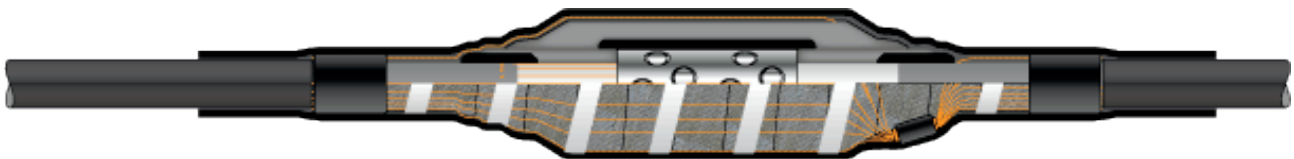

# ABB Joint

## SMPGB PREMOLDED THREE PIECE CABLE JOINT

Premolded cable joints for XLPE insulated cables with aluminum or copper conductors and various types of cable screens and cable sheaths. The joint is available with or without integrated screen interruption for cross bonding of cable screens. Designed to meet the requirements of internationally accepted standards.

The joint consists of a premolded rubber tube, two premolded rubber adaptors, and a bolt cable clamp. Bolt technology facilitates jointing of the conductor and also allows jointing of different cross sections.

- Available with or without screen interruption
- Supplied with bolted connector
- Prefabricated PUR casted copper casing for cable with metallic sheath
- Accommodates transition between different cable types and sizes
- Meets the requirements of IEC 60840 including Annex G, IEC 62067 including Annex G, and IEEE 404 where applicable

Type	SMPGB	SMPGB	SMPGB
Operation Voltage Um (kV)	145	170	420
Conductor Cu/Al Max. (kcmil)	5000	5000	5000
Diameter Over Dielectric Min.-Max. (inches)	1.9-4.2	2.4-4.2	3.1-4.9
Diameter Over Jacket Max. (inches)	5.1	5.1	6.1
Length (inches)	88.5	88.5	78.7
Outer Diameter (inches)	9.6	9.6	22.6
Insulation Material	EPDM	EPDM	EPDM

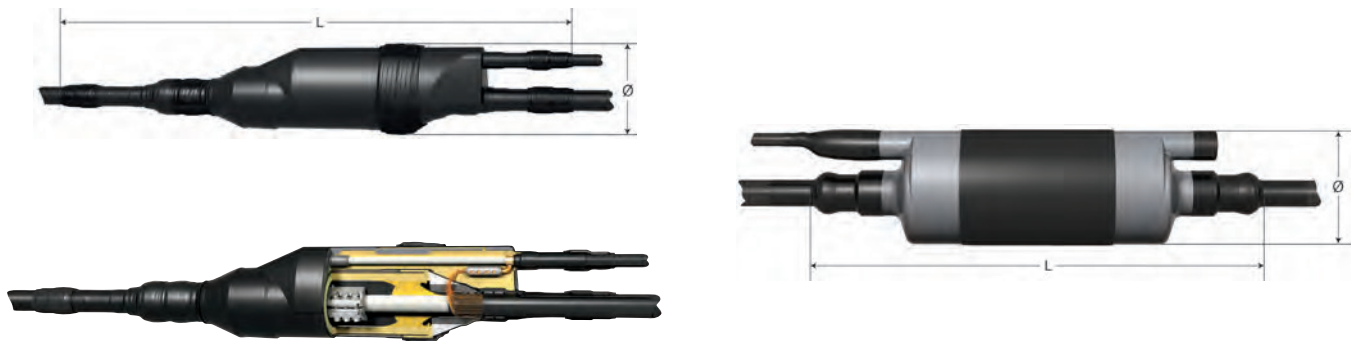

# nkt cables Joint

## SM PREMOLDED THREE PIECE CABLE JOINT



This premolded joint in three-piece design with compact dimensions is made of silicone rubber. Main components of the standard joint are conductor connection, cable adapters, main joint sleeve, and outer protective covering.

- Integrated premolded stress control system with silicone rubber
- Three piece design with compact dimensions
- Screw type or compression conductor connector
- Minimal tool requirement
- Rugged compound-filled metallic casing
- Sealed ABS composite housing for complete moisture tightness
- Version with screen separation available
- Meets the requirements of IEC 60840 including Annex G, IEC 62067 including Annex G, and IEEE 404 where applicable

Operation Voltage Um (kV)	Type	Conductor Cu/Al Max. (kcmil)	Diameter Over Dielectric Max. (inches)	Diameter Joint Approx. (inches)	Length Joint Approx. (inches)
72	SM 72-S Size 3	2500	3.0	16.6	69.3
72	SM 72-S Size 4	3000/2500	3.3		77.4
72	SM 72-S Size 6	5000/2500	4.3		82.9
115	SM 115-S Size 3	2500	3.0	16.6	69.3
115	SM 115-S Size 4	3000/2500	3.3		77.4
115	SM 115-S Size 6	5000/2500	4.3		82.9
145	SM 145-S Size 4	3000/2500	3.3	16.6	77.4
145	SM 145-S Size 6	5000/2500	4.3		82.9
245	SM 245-S Size 7	5000/2500	4.3	18.6	82.9
345/420	SM 420-S Size 8	5000	4.8	26.4	93.3

<sup>1</sup>2500 up to 5000 kcmil special crimping tool is required



# Cable Clamps

Southwire is proud to introduce its own line of Underground Transmission Solutions cable clamps, made of anodized aluminum. Every set includes the requisite parts (nuts, bolts, and washers) for secure mounting and can be equipped with compression springs to accommodate various sheathing options.

In addition, Southwire can offer an array of clamp sizes and materials, including epoxy, from supply channel partners. These will also include the requisite parts and springs for various sheathing options.

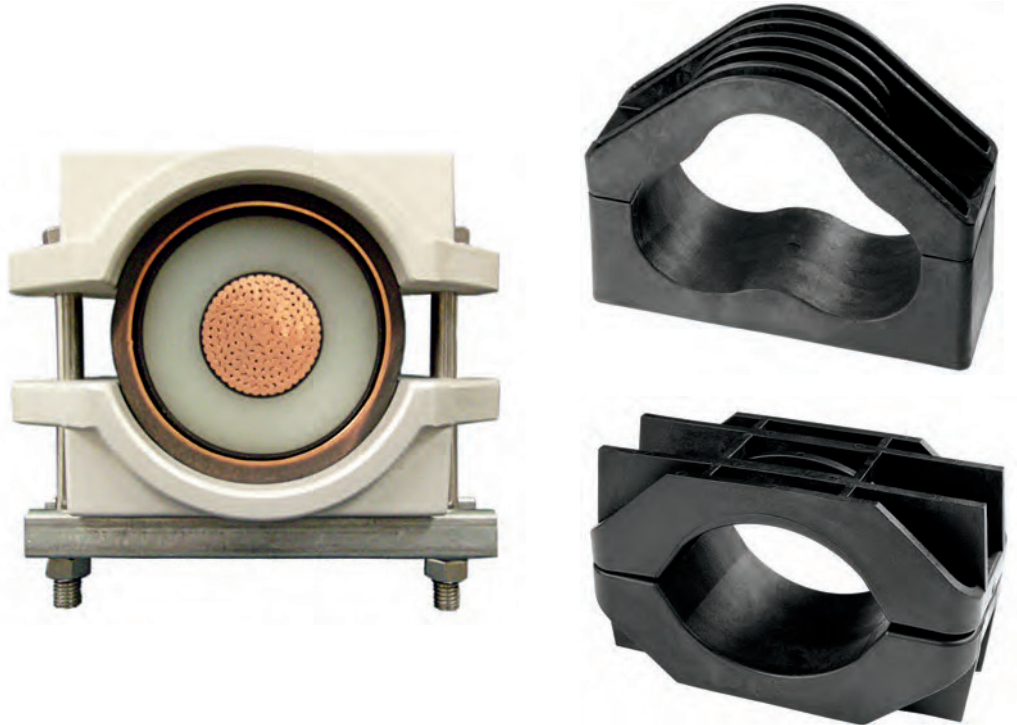

# Link Boxes

Southwire offers an array of sheath grounding link boxes to complete the desired sheath grounding arrangement. Link boxes are used in combination with terminations and splices to limit cable sheath voltage rise. Lightning, fault currents, and switching operations can cause over voltages on the cable sheath. The link box optimizes loss management in the cable shield on cables grounded on both sides.

- Stainless steel box
- Moisture-tight and water-impervious options available for both outdoor and vault applications
- Suitable for all voltage classes
- Zinc oxide sheath voltage limiters
- Single point, cross-bonding, and direct grounding versions available, with or without removable links
- Accommodates single core or concentric bonding cables of different diameters
- 1 phase and 3 phase boxes
- Different mechanical protection levels up to IP68
- Short circuit current up to 63 kA for 1 sec



# Bonding Cable

Southwire offers single conductor insulated cables in standard conductor sizes to be used in conjunction with link boxes to complete the desired bonding scheme. Options include cables that are type USE-2/RHH/RHW-2 rated and Underground Transmission Solutions Bonding/Grounding cable meeting AEIC CS9 requirements. Both are abrasion, moisture, heat, fire, and sunlight resistant black cross-linked polyethylene insulated. The copper conductor is annealed and moisture blocked and rated for 90°C normal operation.





# Standard Cable Reels

Cable Lengths in Feet on Standard Steel Reels								
Diameter	S422	S431	S622	S650	S778	S830	S869	S1013
(inches)	82x108	94x118	95x126	94x138	95x150	95x158	95x158	95x158
2.0	5000							
2.1	5000							
2.2	5000							
2.3	5000							
2.4	4750	5000						
2.5	4600	4375	5000					
2.6	3875	4250	5000					
2.7	3725	4150	5000					
2.8	3600	4000	5000					
2.9	3075	3125	5000					
3.0	2975	3050	5000					
3.1	2850	2925	4125	5000				
3.2	2725	2825	4150	3875	5000			
3.3	2250	2700	4000	3700	5000			
3.4	2150	2725	3850	3725	4825	5000		
3.5	2175	2025	3050	3600	3850	4125	4300	5000
3.6	2075	1925	3075	3425	3875	4125	3500	5000
3.7	2075	1950	3950	2775	3700	3950	3350	5000
3.8		1850	2975	2650	3725	3975	3375	5000
3.9		1850	2825	2675	3550	3800	3225	4075
4.0		1750	2850	2525	3575	3800	3225	4100
4.1		1775	2175	2550	2725	2925	3050	3900
4.2		1675	2200	2425	2750	2950	3075	3750
4.3		1200	2075	2425	2600	2800	2250	3725
4.4				2300	2625	2800	2250	3500
4.5					2475	2650	2125	2925
4.6					2500	2650	2150	
4.7					2500	2650	2150	
4.8					2350	2500	2025	
4.9						1925	2025	
5.0						1950	2025	

Information provided for preliminary engineering information only and is subject to verification. Additionally, a freight logistics and routing study must be performed in reference to the final delivery location(s). Lengths provided based on diameter information only, gross weights shall be verified.

# Project Questionnaire

Southwire and its Underground Solutions engineers are ready to help develop the most cost effective solutions for each customer's individual needs. As an engineered system, the attention to detail for informational input(s) will generate enhanced output(s). Please fill in the form to the right and give us a call to get started today.

General & Contact Information	
Your Company Name:	Phone:
End User Name:	Address:
Role of Your Company in the Project:	E-mail:
Contact Name:	Other:
Project Information & Schedule	
Project Name or Identification:	Request for Quotation Expected Date:
Project Location:	Delivery and Installation Dates/Schedule:
Project Description (substation, OHL dip...):	Scope of Work to be Requested (turn key, installation, supervision):
Purpose of this Request (feasibility, budgetary, actual purchase quote request...):	Other:
Installation	
Nominal System Operating Voltage:  kV	Number of Cables per Phase:
Conductor Material and Size:  kcmil	Type of Terminations (AIS, GIS, Xformer) and Quantity:
Radial Water Protection:  Yes/No	Type of Joints (3 piece, 1 piece) and Quantity:
Sheath Construction (Al/Cu Corr Sheath, Al/Cu Lam w/ Al/Cu screen wires):	Installation Method (duct bank, direct buried...) provide drawing or sketch:
BIL:  kV	Ambient Temperature (soil temp. if buried):  °C
Ampacity or Load:  A or MVA	Thermal Resistivity of Soil:  °C-cm/W
Load Factor:  %	Thermal Resistivity of Duct Bank Concrete:  °C-cm/W
Fault Current and Duration:  kA - sec	Thermal Resistivity of Thermal Backfill:  °C-cm/W
Cable Route Length:  ft or miles	Max Laying Depth (to top of duct bank or bottom of duct bank):  ft
Cable Max Cut Length:  ft	Number of Circuits:
Preferred Bonding Schematic (single point bonded, cross bonded, mixed or solidly bonded):	Other:





# UNDERGROUND TRANSMISSION SOLUTIONS



**Southwire®**

**SOUTHWIRE COMPANY, LLC**

One Southwire Drive  
Carrollton, Georgia 30119

800-444-1700  
[www.southwire.com](http://www.southwire.com)

© Southwire Company, LLC. All Rights Reserved.

**Edition 2016.2**